

# 热交换系统 **5** 件套

## AUTO COOLING SYSTEM

电子风扇

Cooling Fan Assembly

水箱

Radiator Assembly

冷凝器

Condenser Assembly

中冷器

Intercooler Assembly

鼓风机

Heater Blower Motor

让每个汽配产品都值得信赖

MAKE EVERY AUTO PARTS RELIABLE

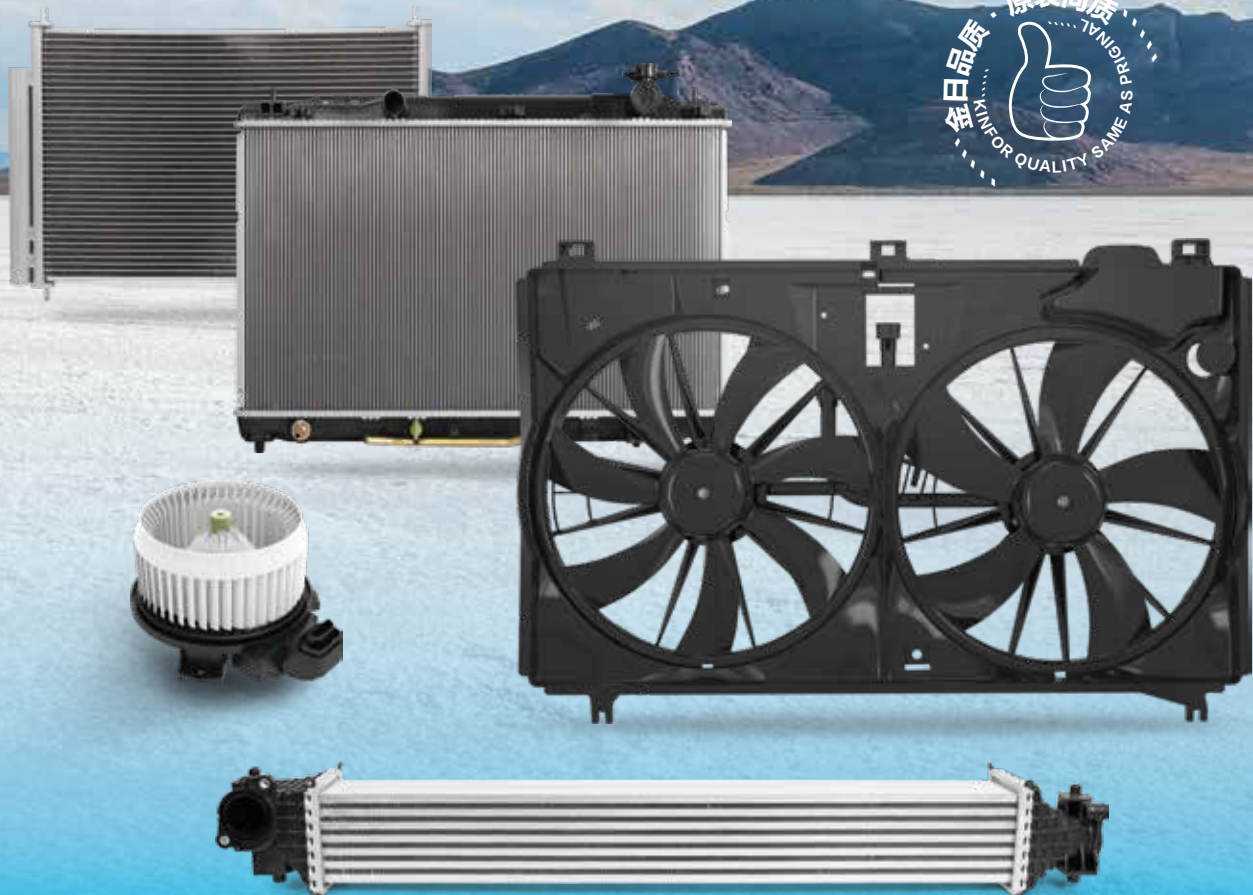



原 装 同 质 · 金 日 品 质

KINFOR QUALITY · SAME AS ORIGINAL

电子风扇

Cooling Fan Assembly

水箱

Radiator Assembly

冷凝器

Condenser Assembly

中冷器

Intercooler Assembly

鼓风机

Heater Blower Motor



微信扫一扫 关注我们



杭州金日汽车零部件有限公司  
HANGZHOU GOLDEN SUN AUTOPARTS CO.,LTD

地址：浙江省杭州市临平区康信路603-1号

ADD: No. 603-1, Kangxin Road, Lingping District, Hangzhou City, Zhejiang Province, China.

网址 / WEB: [www.hzgoldensun.com](http://www.hzgoldensun.com)

内销 / DOMESTIC: 0571-26238586

外贸 / INTERNATIONAL: 86-571-26238591

邮编 / POSTCODE: 311101

让每个汽配产品都值得信赖

MAKE EVERY AUTO PARTS RELIABLE



## 公司简介 COMPANY PROFILE



杭州金日汽车零部件有限公司成立于2004年，是一家致力于各项汽车零部件研发、生产、销售为一体的专业制造商。公司旗下拥有qxp（倒车镜、大灯清洗电机）、KINFOR（电子风扇、水箱、冷凝器、中冷器、保险杠、大灯、雾灯、中网、尾灯、发电机、起动机、气囊游丝、鼓风机马达）、AI（汽车脚垫、储物箱等）、V-EMP（萬璞）等知名品牌。

杭州金日的所有产品主要定位为全球汽车售后市场和OEM配套服务，凭借优良的品质和完善的服务体系，已将产品远销欧洲、北美洲、中东、非洲以及东南亚等地区。公司拥有国内一流的生产设备、生产工艺和检验设备，再加上完整的研发团队，精良的生产技术和先进的管理体系，确保了产品优良的品质。

本公司所有产品，均严格按照国家标准，根据原厂设计理念，制定企业研发生产标准。公司本着品质创造价值的管理理念，最大程度满足客户对产品性价比的要求。

Hangzhou Golden Sun Auto Parts Co., Ltd. was established in 2004, which is a professional auto parts manufacturer with research & development departments.

Golden Sun owns 4 brands as qxp (side mirror, head lamp washer), Kinfor (cooling fan, Radiator, condenser, Intercooler, Bumper, Head light, Front Fog light, Grille, Tail light, alternator, starter, clock spring, AC heater blower etc.), AI (floor mat, storage box) and V-EMP.

The main business of Golden sun is about OE replacement aftermarket and truck accessories. With the excellent quality and perfect service, our products have been exported to the United States, Europe, the Middle East, Southeast Asia, Japan, Africa and other regions.

Golden Sun has a professional research & development team, and top-class production equipment, and a great quality control system. All of these support company's business runs well!

All products of Golden Sun are totally obey the China GB standards. We deeply believe that quality creates profit, and we always try our best to satisfy customers' requirement of cost-effective purchasing.

# 热交换系统 5 件套

## AUTO COOLING SYSTEM

电子风扇

Cooling Fan Assembly

水箱

Radiator Assembly

冷凝器

Condenser Assembly

中冷器

Intercooler Assembly

鼓风机

Heater Blower Motor



## 企业荣誉

### COMPANY HONOR



高新技术企业证书  
National High-tech Enterprises Certification



商标证书  
LOGO Authorization



### 实用新型专利证书

PATENT CERTIFICATE OF NEW UTILITY



# 目录 CONTENTS

**产品目录**  
Page Index 4-23

**电子风扇**  
Cooling Fan Assembly 4-11

奥迪AUDI .....	4	大众VOLKSAGEN .....	11
丰田TOYOTA .....	5-6	现代起亚HYUNDAI/KIA ..	11
雷克萨斯LEXUS .....	6		
传祺TRUMPCHI .....	6		
本田HONDA .....	7-8		
日产NISSAN .....	9		
马自达MAZDA .....	10		



**水箱**  
Radiator Assembly 12-16

丰田TOYOTA .....	13
本田HONDA .....	14
日产NISSAN .....	15
马自达MAZDA .....	16



**冷凝器**  
Condenser Assembly 17-19

本田HONDA .....	17
日产NISSAN .....	18
丰田TOYOTA .....	19
马自达MAZDA .....	19



**中冷器**  
Intercooler Assembly 20

本田HONDA .....	20
日产NISSAN .....	20
丰田TOYOTA .....	20



**鼓风机**  
Heater Blower Motor 21-23

本田HONDA .....	21
日产NISSAN .....	22
丰田TOYOTA .....	23



电子风扇  
Cooling Fan Assembly

水箱  
Radiator Assembly

冷凝器  
Condenser Assembly

中冷器  
Intercooler Assembly

鼓风机  
Heater Blower Motor

适用**奥迪**系列 FOR AUDI SERIES

电子风扇Cooling Fan Assembly

工厂编号 COMPANY NO	车型 MODEL	年份 YEAR	页码 PAGE
CFAC01	奥迪/AUDI A6L 2.0T 2.4L 2.8L 3.0L 3.2L	2005-2012	26
CFAC02	奥迪/AUDI A6L 2.0T 2.4L 2.8L 3.0L 3.2L	2005-2012	26
CFAC09	奥迪 (主)/AUDI A3 1.6L	2006-2013	26
CFAC12	奥迪 (副)/AUDI A3 1.6L	2006-2013	26
CFAC13	奥迪 (双风扇)/AUDI A3 1.6L	2006-2013	27
CFAC03	奥迪/AUDI A4L	2009-2016	27
CFAC04	奥迪/AUDI A4L	2009-2016	27
CFAC15	奥迪/AUDI A4 2.0T	2015-	27
CFAC05	奥迪/AUDI Q5L/C8/C9	2016	28
CFAC06	奥迪/AUDI A4L 2.0TFS/3.2FSI//Q5 2.0TFS	2008-2016	28
CFAC16	奥迪 (主)/AUDI A6 2.4L	2005-2011	28
CFAC11	奥迪 (副)/AUDI A6 2.4L	2005-2011	28
CFAC07	奥迪/AUDI A6 3.0L	2012-2018	29
CFAC14	奥迪 (主)/AUDI A7 2.0L	2012-2018	29
CFAC10	奥迪 (副)/AUDI A7 2.0L	2012-2018	29
CFAC18	奥迪 (主)/AUDI A8 3.0T	2010-2017	29
CFAC08	奥迪 (副)/AUDI A8 3.0T	2010-2017	30
CFAC19	奥迪 (主)/AUDI Q5 2.5L	2009-2015	30
CFAC17	奥迪 (副)/AUDI Q5 2.5L	2009-2015	30
CFAC20	奥迪 (主)/AUDI Q7 3.0T	2007-2011	30
CFAC21	奥迪 (副)/AUDI Q7 3.0T	2007-2011	31



适用丰田系列 FOR TOYOTA SERIES

电子风扇 Cooling Fan Assembly

工厂编号 COMPANY NO	车型 MODEL	年份 YEAR	页码 PAGE
CFTC01	皇冠/CROWN	2005-2010	33
CFTC16	皇冠/CROWN 2.5L	2015	33
CFTC17	皇冠/CROWN 2.0T	2015	33
CFTC37	皇冠陆放/AXUH7 #陆	2021	33
CFTC02	锐志/MARK-X/REIZ	2006-2008	34
CFTC57	凯美瑞 (冷气)/CAMRY (COND FAN) 2.2L	1992-1996	34
CFTC19	佳美/CAMRY 2.4L	2004	34
CFTC70	凯美瑞/CAMRY 2.4L	2002-2006	34
CFTC71	凯美瑞/CAMRY 3.0L	2002-2006	35
CFTC03	凯美瑞/CAMRY	2006-2011	35
CFTC73	凯美瑞/CAMRY 2.4L	2007-2009	35
CFTC74	凯美瑞混动版/CAMRY HYBRID 2.4L	2007-2011	35
CFTC75	凯美瑞/CAMRY 3.5L	2007-2011	36
CFTC76	凯美瑞/CAMRY 3.5L	2012-2017	36
CFTC04	凯美瑞/CAMRY	2012-2017	36
CFTC77	凯美瑞混动版/CAMRY HYBRID 3.0L	2012-2017	36
CFTC26	凯美瑞混动版/CAMRY HYBRID	2018	37
CFTC27	凯美瑞/CAMRY	2018	37
CFTC78	RAV4 (COND FAN) 2.2L	1996-2000	37
CFTC05	RAV4	2010-2013	37
CFTC06	RAV4	2014	38
CFTC36	威兰达/WILDLANDER	2020	38
CFTC85	卡罗拉 (水箱)/COROLLA (RAD FAN) 1.6L	1988-1992	38
CFTC88	卡罗拉/COROLLA 1.6L 1.8L	1993-1997	38
CFTC89	卡罗拉/COROLLA 1.6L 1.8L	1996-1997	39
CFTC08	花冠/COROLLA	2003-2006	39
CFTC42	卡罗拉/COROLLA	2003-2007	39
CFTC10	花冠/COROLLA	2007	39
CFTC09	卡罗拉/COROLLA	2007	40
CFTC46	卡罗拉/COROLLA	2007-2013	40
CFTC92	卡罗拉/COROLLA 1.8L	2009-2013	40
CFTC18	卡罗拉混合动力/COROLLA HYBRID	2014	40
CFTC20	卡罗拉/COROLLA 1.2T	2017	41
CFTC40	卡罗拉 (美版)/COROLLA 1.8	2014-2018	41
CFTC50	卡罗拉/COROLLA ALTIS	2014-2018	41
CFTC93	卡罗拉/COROLLA 2.0L	2018-2019	41
CFTC47	卡罗拉/COROLLA	2020	42
CFTC144	卡罗拉锐放 燃油版/COROLLA (MXGA10) 2.0L	2022-	42
CFTC145	卡罗拉锐放 混动版/COROLLA HYBRID (MXGH10) 2.0L	2023-	42
CFTC21	汉兰达/HIGHLANDER 3.5L	2009-2014	42
CFTC95	汉兰达/HIGHLANDER 3.5L	2008-2010	43
CFTC96	汉兰达/HIGHLANDER 3.5L	2011-2013	43
CFTC97	汉兰达混动版/HIGHLANDER HYBRID 3.3L	2008-2010	43
CFTC07	汉兰达/HIGHLANDER 2.7L	2009-2014	43
CFTC99	汉兰达/HIGHLANDER 2.7L	2009-2013	44
CFTC100	汉兰达/HIGHLANDER 2.7L 3.5L	2014-2018	44
CFTC14	汉兰达/HIGHLANDER 2.0T	2015	44
CFTC38	汉兰达/HIGHLANDER	2021	44
CFTC11	威驰 (水箱)/VIOS (RAD FAN)	2002-2005	45
CFTC29	威驰 (冷气)/VIOS (COND FAN)	2002-2005	45

工厂编号 COMPANY NO	车型 MODEL	年份 YEAR	页码 PAGE
CFTC12	威驰/VIOS	2008-2013	45
CFTC13	威驰/VIOS	2014	45
CFTC24	老霸道/PRADO GRJ120	2003-2009	46
CFTC22	霸道/PRADO GRJ150 4.0L	2010-2013	46
CFTC25	霸道/PRADO GRJ150 2.7L	2013-2017	46
CFTC23	酷路泽/LAND CRUISER	2008-2013	46
CFTC15	酷路泽/LAND CRUISER ZJ100	2005-2007	47
CFTC28	雷凌/LEVIN 1.2T	2019-	47
CFTC39	雷凌/LEVIN 1.5T	2018-	47
CFTC32	奕泽/IZOA	2018-	47
CFTC36	威兰达/WILDLANDER	2020-	48
CFTC120	亚洲龙/AVALON-R	2000-2004	48
CFTC127	亚洲龙/AVALON-L	2000-2004	48
CFTC122	亚洲龙/AVALON	2005-2012	48
CFTC123	普锐斯/PRIUS	2004-2009	49
CFTC125	塞恩/SCION XA XB	2004-2006	49
CFTC124	特赛尔/TERCEL MT//帕萨奥/PASEO MT	1995-1998	49
CFTC131	特赛尔/TERCEL AT//帕萨奥/PASEO AT	1995-1998	49
CFTC142	特赛尔/TERCEL//帕萨奥/PASEO	1995-1998	50
CFTC135	塞纳 两驱/SIENNA 3.3L	2003-2005	50
CFTC143	塞纳 四驱/SIENNA 3.3L	2003-2005	50
CFTC139	塞纳/SIENNA 3.5L	2011-2016	50
CFTC136	海狮/HIACE	1999-2005	51
CFTC146	普瑞维亚/ACR50-新款	2006-2019	51

适用雷克萨斯系列 FOR LEXUS SERIES

电子风扇Cooling Fan Assembly

工厂编号 COMPANY NO	车型 MODEL	年份 YEAR	页码 PAGE
CFTC107	雷克萨斯/LEXUS RX270 2.7L AT MT	2010-2015	53
CFTC113	雷克萨斯/LEXUS RX350 3.5L	2006-2008	53
CFTC114	雷克萨斯/LEXUS RX350 3.5L	2010-2015	53
CFTC116	雷克萨斯/LEXUS ES200 2.0L AT MT	2018-2019	53
CFTC111	雷克萨斯/LEXUS ES240 2.4L 5AT MT	2009-2012	54
CFTC118	雷克萨斯/LEXUS ES250 2.5L AT MT	2012-2018	54
CFTC26	雷克萨斯/LEXUS ES300H 2.5L	2019-2021	54
CFTC25	雷克萨斯/LEXUS GX460	2009-	54
CFTC24	雷克萨斯/LEXUS GX470	2002-2009	55
CFTC15	雷克萨斯/LEXUS LX470	1998-2007	55
CFTC23	雷克萨斯/LEXUS LX570	2007-	55

适用传祺系列 FOR TRUMPCHI SERIES

电子风扇Cooling Fan Assembly

工厂编号 COMPANY NO	车型 MODEL	年份 YEAR	页码 PAGE
CFGC01	传祺系列/TRUMPCHI GA3/GA3S 1.6L	2013-2014	57
CFGC05	传祺系列/TRUMPCHI GA8	2016	57
CFGC06	传祺系列/TRUMPCHI GS8	2016	57
CFGC02	传祺系列/TRUMPCHI GS5 2.0L	2012-2014	57
CFGC03	传祺系列/TRUMPCHI GS5 1.8T	2012-2014	58
CFGC04	传祺系列/TRUMPCHI GS4	2015	58
CFGC08	传祺系列/TRUMPCHI GA6 1.5T	2019	58





适用本田系列 FOR HONDA SERIES

电子风扇Cooling Fan Assembly

工厂编号 COMPANY NO	车型 MODEL	年份 YEAR	页码 PAGE
CFHS03	三厢飞度 (水箱)/CITY (RAD FAN)	2003-2004	59
CFHL03	三厢飞度 (冷气)/CITY (COND FAN)	2003-2004	59
CFHS02	飞度 (水箱)/FIT/JAZZ (RAD FAN)	2005-2006	59
CFHL02	飞度 (冷气)/FIT/JAZZ (COND FAN)	2005-2006	59
CFHS54	飞度 (水箱)/FIT/JAZZ (RAD FAN)	2007-2008	60
CFHL54	飞度 (冷气)/FIT/JAZZ (COND FAN)	2007-2008	60
CFHS05	飞度 (水箱)/FIT/JAZZ (RAD FAN)	2009-2013	60
CFHL05	飞度 (MT) (冷气)/FIT/JAZZ (MT) (COND FAN)	2009-2013	60
CFHL27	飞度 (AT) (冷气)/FIT/JAZZ (AT) (COND FAN)	2009-2013	61
CFHS06	飞度 (水箱)/FIT/JAZZ (RAD FAN)	2014	61
CFHL06	飞度 (冷气)/FIT/JAZZ (COND FAN)	2014	61
CFHL55	飞度 (冷气)/FIT/JAZZ (COND FAN) 1.5L	2015-2020	61
CFHS19	锋范 (水箱)/CITY (RAD FAN) 1.8L	2009-2014	62
CFHL19	锋范 (冷气)/CITY (COND FAN) 1.8L	2009-2014	62
CFHS69	锋范 (水箱)/CITY (RAD FAN) 1.5L	2019	62
CFHL69	锋范 (冷气)/CITY (COND FAN) 1.5L	2019	62
CFHS30	哥瑞 (水箱)/GREIZ (RAD FAN)	2015	63
CFHL30	哥瑞 (冷气)/GREIZ (COND FAN)	2015	63
CFHS09	奥德赛 (水箱)/ODYSSEY (RAD FAN)	2005-2008	63
CFHL09	奥德赛 (冷气)/ODYSSEY (COND FAN)	2005-2008	63
CFHS58	奥德赛 (水箱)/ODYSSEY (RAD FAN) 3.5L (北美)	2005-2010	64
CFHL58	奥德赛 (冷气)/ODYSSEY (COND FAN) 3.5L (北美)	2005-2010	64
CFHS08	奥德赛 (水箱)/ODYSSEY (RAD FAN)	2009-2014	64
CFHL08	奥德赛 (冷气)/ODYSSEY (COND FAN)	2009-2014	64
CFHS07	奥德赛 (水箱)/ODYSSEY (RAD FAN)	2015-	65
CFHL07	奥德赛 (冷气)/ODYSSEY (COND FAN)	2015-	65
CFHL64	奥德赛 (冷气)/ODYSSEY (COND FAN) 3.5L	2011-2017	65
CFHC42	奥德赛/ODYSSEY//艾力绅 混动版/ELYSION HYBRID	2019-	65
CFHC17	7代雅阁/7TH GEN ACCORD 2.4L	2003-2007	66
CFHS18	7代雅阁 (水箱)/7TH GEN ACCORD (RAD FAN) 3.0L	2003-2007	66
CFHL18	7代雅阁 (冷气)/7TH GEN ACCORD (COND FAN) 3.0L	2003-2007	66
CFHS15	8代雅阁 (水箱)/8TH GEN ACCORD (RAD FAN) 2.0L	2008-2013	66
CFHL15	8代雅阁 (冷气)/8TH GEN ACCORD (COND FAN) 2.0L	2008-2013	67
CFHS14	8代雅阁 (水箱)/8TH GEN ACCORD (RAD FAN) 2.4L	2008-2013	67
CFHL14	8代雅阁 (冷气)/8TH GEN ACCORD (COND FAN) 2.4L	2008-2013	67
CFHS16	8代雅阁 (水箱)/8TH GEN ACCORD (RAD FAN) 3.5L	2008-2013	67
CFHL01	8代雅阁 (冷气)/8TH GEN ACCORD (COND FAN) 3.5L	2008-2013	68
CFHS11	9代雅阁 (水箱)/9TH GEN ACCORD (RAD FAN) 2.0L	2014	68
CFHL11	9代雅阁 (冷气)/9TH GEN ACCORD (COND FAN) 2.0L	2014	68
CFHS12	9代雅阁 (水箱)/9TH GEN ACCORD (RAD FAN) 2.4L	2014	68
CFHL12	9代雅阁 (冷气)/9TH GEN ACCORD (COND FAN) 2.4L	2014	69
CFHS11	9代雅阁 (水箱)/9TH GEN ACCORD (RAD FAN) 3.0L	2014	69
CFHL13	9代雅阁 (冷气)/9TH GEN ACCORD (COND FAN) 3.0L	2014	69
CFHS34	10代雅阁 (水箱)/10TH GEN ACCORD (RAD FAN) 1.5T	2018	69
CFHL34	10代雅阁 (冷气)/10TH GEN ACCORD (COND FAN) 1.5T	2018	70
CFHC35	10代雅阁 (混动)/10TH GEN ACCORD HYBRID 2.0L	2018	70
CFHS28	思铂睿 (水箱)/SPIRIOR (RAD FAN) 2.4L	2010-2014	70
CFHL14	思铂睿 (冷气)/SPIRIOR (COND FAN) 2.4L	2010-2014	70
CFHC40	思铂睿/SPIRIOR //9代雅阁 混动/9TH GEN ACCORD HYBRID	2017	71
CFHS01	歌诗图 (水箱)/CROSSTOUR (RAD FAN)	2014-2016	71

工厂编号 COMPANY NO	车型 MODEL	年份 YEAR	页码 PAGE
CFHL01	歌诗图 (冷气)/CROSSTOUR (COND FAN)	2014-2016	71
CFHS22	CR-V (水箱)/CR-V (RAD FAN)	2002-2006	71
CFHL22	CR-V (冷气)/CR-V (COND FAN)	2002-2006	72
CFHS23	CR-V (水箱)/CR-V (RAD FAN)	2007-2011	72
CFHL23	CR-V (冷气)/CR-V (COND FAN) 2.0L	2007-2011	72
CFHL37	CR-V (冷气)/CR-V (COND FAN) 2.4L	2007-2011	72
CFHS24	CR-V (水箱)/CR-V (RAD FAN)	2012-2014	73
CFHL38	CR-V (冷气)/CR-V (COND FAN) 2.0L	2012-2014	73
CFHL24	CR-V (冷气)/CR-V (COND FAN) 2.4L	2012-2014	73
CFHS32	CR-V (水箱)/CR-V (RAD FAN)	2015-2016	73
CFHL32	CR-V (冷气)/CR-V (COND FAN)	2015-2016	74
CFHS33	CR-V (水箱)/CR-V (RAD FAN)	2017	74
CFHL33	CR-V (冷气)/CR-V (COND FAN)	2017	74
CFHC39	CR-V 混动版/CR-V HYBRID	2017	74
CFHS74	CR-Z (水箱)/CR-Z (RAD FAN) 1.5L	2011-2016	75
CFHL74	CR-Z (冷气)/CR-Z (COND FAN) 1.5L	2011-2016	75
CFHS26	思域 (水箱)/CIVIC (RAD FAN)	2006-2011	75
CFHL26	思域 (冷气)/CIVIC (COND FAN)	2006-2011	75
CFHS25	思域 (水箱)/CIVIC (RAD FAN)	2012-2014	76
CFHL25	思域 (冷气)/CIVIC (COND FAN)	2012-2014	76
CFHL77	思域 (冷气)/CIVIC (COND FAN) 1.8L (北美)	2012-2015	76
CFHC29	思域/CIVIC 1.5T	2016	76
CFHS41	思域 (水箱)/CIVIC (RAD FAN) 1.5T	2022-2023	77
CFHL41	思域 (冷气)/CIVIC (COND FAN) 1.5T	2022-2023	77
CFHS20	缤智 (水箱)/VEZEL (RAD FAN)	2015	77
CFHL20	缤智 (冷气)/VEZEL (COND FAN)	2015	77
CFHS21	杰德 (水箱)/JADE (RAD FAN)	2014	78
CFHL21	杰德 (冷气)/JADE (COND FAN)	2014	78
CFHS31	冠道 (水箱)/AVANCIER (RAD FAN)	2016	78
CFHL31	冠道 (冷气)/AVANCIER (COND FAN)	2016	78
CFHS10	艾力绅 (水箱)/ELYSION (RAD FAN)	2012	79
CFHL10	艾力绅 (冷气)/ELYSION	2012	79
CFHS04	理念 (水箱)/EVERUS (RAD FAN)	2007-2008	79
CFHL03	理念 (冷气)/EVERUS (COND FAN)	2007-2008	79
CFHS36	凌派 (水箱)/CRIDER (RAD FAN) 1.0T	2019	80
CFHL36	凌派 (冷气)/CRIDER (COND FAN) 1.0T	2019	80
CFHS52	致在 (水箱)/ZR-V (RAD FAN) 1.5T	2022-2023	80
CFHL52	致在 (冷气)/ZR-V (COND FAN) 1.5T	2022-2023	80
CFHS80	山脊 (水箱)/RIDGELINE (RAD FAN)	2006-2008	81
CFHL80	山脊 (冷气)/RIDGELINE (COND FAN)	2006-2008	81
CFHS81	山脊 (水箱)/RIDGELINE (RAD FAN) 3.5L	2009-2014	81
CFHL81	山脊 (冷气)/RIDGELINE (COND FAN) 3.5L	2009-2014	81
CFHL89	讴歌 (冷气)/ACURA RDX (COND FAN) 2.3L	2007-2012	82
CFHS97	讴歌 (水箱)/ACURA ZDX (RAD FAN) 3.7L	2010-2013	82
CFHS98	HR-V (水箱)/HR-V (RAD FAN) 1.8L	2016-2020	82



## 适用日产系列 FOR NISSAN SERIES

电子风扇 Cooling Fan Assembly

工厂编号 COMPANY NO	车型 MODEL	年份 YEAR	页码 PAGE
CFRC01	逍客/QASHQAI	2008-2014	83
CFRC18	逍客/QASHQAI/ROGUE SPORT 2.0L 1.2T	2015	83
CFRC17	老风度/CEFIRO	2000-2005	83
CFRC15	老蓝鸟/BLUE BIRD	2000-2005	83
CFRC37	轩逸/SENTRA (MT) 1.6L	1991-1994	84
CFRC44	轩逸/SENTRA 1.6L 2.0L	1995-1999	84
CFRC38	轩逸/SENTRA	1996-2000	84
CFRC43	轩逸/SENTRA 1.8L 2.0L	2000-2001	84
CFRC40	轩逸/SENTRA 1.8L	2002-2006	85
CFRC45	轩逸/SENTRA 2.5L	2002-2006	85
CFRC03	轩逸/SYLPHY 1.6L	2006-2011	85
CFRC04	轩逸/SYLPHY/SENTRA 2.0L	2008-2011	85
CFRC46	轩逸/SENTRA 2.0L	2007-2017	86
CFRC47	轩逸/SENTRA 2.5L	2007-2017	86
CFRC02	轩逸/SYLPHY/SENTRA 1.6L	2012-2018	86
CFRC05	轩逸/SYLPHY/SENTRA 1.8L	2012-2018	86
CFRC22	轩逸/SYLPHY/SENTRA 1.6L	2019	87
CFRC06	奇骏/X-TRAIL /ROGUE 2.0L 2.5L	2009-2013	87
CFRC07	奇骏 /X-TRAIL/ROGUE	2014	87
CFRC08	骐达/TIIDA	2006-2010	87
CFRC19	骐达/TIIDA 1.6T	2011	88
CFRC09	骐达/TIIDA 1.6L	2012	88
CFRC49	天籁/ALTIMA	1998-2001	88
CFRC10	天籁/TEANA/ALTIMA	2003-2007	88
CFRC11	天籁/TEANA/ALTIMA 2.0L/3.5L	2008-2012	89
CFRC50	天籁/ALTIMA 2.5L/3.5L	2007-2018	89
CFRC23	天籁/ALTIMA 2.0L	2019	89
CFRC24	天籁/ALTIMA 2.0T	2019	89
CFRC16	阳光/SUNNY	2003-2007	90
CFRC12	阳光/SUNNY	2010-2013	90
CFRC83	阳光/SUNNY	2013-2015	90
CFRC51	新阳光/VERSA 1.6L/1.8L	2007-2013	90
CFRC31	新阳光/VERSA (单插)	2014-2018	91
CFRC32	新阳光/VERSA (双插)	2012-2019	91
CFRC52	新阳光/VERSA	2020-2022	91
CFRC14	启辰/VELOCIA D50	2012	91
CFRC25	东风日产/JUKE 1.6L	2010-2019	92
CFRC20	劲客/KICKS 1.5L	2017	92
CFRC52	劲客/KICKS 1.6L	2017	92
CFRC21	楼兰/MURANO 2.5L	2015	92
CFRC59	西玛/MAXIMA 2.5L 3.5L	2004-2008	93
CFRC63	西玛/MAXIMA 3.5L	2009-2015	93
CFRC67	英菲尼迪/INFINITI FX35	2009	93
CFRC68	英菲尼迪/INFINITI FX45	2003-2008	93
CFRC69	英菲尼迪/INFINITI FX50	2009-2013	94
CFRC71	英菲尼迪/INFINITI JX35 3.5L	2013	94
CFRC19	英菲尼迪/INFINITI ESQ 1.6T	2014	94
CFRC33	英菲尼迪/INFINITI ESQ 1.6L	2014-2016	94
CFRC82	楼兰/MURANO	2007-2013	95
CFRC78	楼兰/MURANO 3.5L	2009-2014	95

适用马自达系列 FOR MAZDA SERIES

电子风扇Cooling Fan Assembly

工厂编号 COMPANY NO	车型 MODEL	年份 YEAR	页码 PAGE
CFMC01	马自达2/MAZDA 2	2008-2014	97
CFMC04	马自达3/MAZDA 3	2006-2012	97
CFMC09	马自达5/MAZDA 5	2008-2010	97
CFMC06	马自达5/MAZDA 5	2011	97
CFMC11	马自达6/MAZDA 6	2003-2012	98
CFMC02	马自达3星骋/MAZDA 3 1.6L	2011	98
CFMC05	昂克赛拉/MAZDA 3	2014-2018	98
CFMC13	昂克赛拉/MAZDA 3	2019	98
CFMC10	阿特兹/MAZDA 6 ATENZA 2.0L	2014	99
CFMC03	MAZDA CX-5	2013	99
CFMC12	MAZDA CX-4	2015	99
CFMC07	睿翼/MAZDA 6 2.0L	2008-2014	99
CFMC08	睿翼/MAZDA 6 2.5L	2008-2014	100
CFMC16	MAZDA 3/L4 122 2.0L 2.3L	2004-2009	100
CFMC17	MAZDA 3/L4 2.0L 2.5L	2010-2013	100
CFMC30	MAZDA 3/L4 2.0L 2.5L	2014-2018	100
CFMC19	MAZDA 3/L4 2.5L	2019-2020	101
CFMC15	MAZDA 6/L4 152 2.5L	2014-2017	101
CFMC23	MAZDA 6/V6 181 3.0L	2003-2008	101
CFMC29	MAZDA CX-7	2007-2009	101
CFMC31	MAZDA CX-7/L4 152 2.5L	2010-2012	102
CFMC46	MAZDA CX-9/V6 213 3.5L/V6 227 3.7L	2007-2015	102
CFMC20	MAZDA TRIBUTE/V6 181 3.0L	2001-2006	102
CFMC27	MAZDA MPV	2000-2001	102
CFMC43	MAZDA PROTEGE5/L4 1.8L	2002-2003	103
CFMC45	MAZDA PROTEGE/L4 2.0L	2001-2003	103
CFMC44	MAZDA RX-8	2004-2008	103

**适用大众系列 FOR VOLKSWAGEN SERIES**

电子风扇Cooling Fan Assembly

工厂编号 COMPANY NO	车型 MODEL	年份 YEAR	页码 PAGE
CFVC03	宝来/BORA	2003-2005	105
CFVC11	宝来/BORA	2005-2010	105
CFVC12	捷达/JETTA	1998-2008	105
CFVC02	捷达/JETTA	2013-2019	105
CFVC14	波罗/POLO	2003-2009	106
CFVC16	波罗/POLO	2010-2014	106
CFVC13	波罗/POLO 1.2L 1.6L	2013-2017	106
CFVC17	高尔夫/GOL	2009-2016	106
CFVC05	朗逸/LAVIDA	2006-2012	107
CFVC01L	朗逸/LAVIDA	2015-2022	107
CFVC01R	朗逸/LAVIDA	2015-2022	107
CFVC06	迈腾/MAGOTAN	2006-2012	107
CFVC10	大众LEON L4 1.4L 1.8L 2.0L	2012-2018	108

**适用现代起亚系列 FOR HYUNDAI/KIA SERIES**

电子风扇Cooling Fan Assembly

工厂编号 COMPANY NO	车型 MODEL	年份 YEAR	页码 PAGE
CFHY18	伊兰特 (水箱)/ELANTRA (RAD FAN)	2005-2008	109
CFHY13	伊兰特 (冷气)/ELANTRA (COND FAN)	2005-2008	109
CFHY10	伊兰特/ELANTRA 1.8L/2.0L	2014-2016	109
CFHY19	索塔纳 (水箱)/SONATA (RAD FAN)	2003-2005	109
CFHY16	索塔纳 (冷气)/SONATA (COND FAN)	2003-2005	110
CFHY04	索塔纳 (美国款)/SONATA (USA)	2015	110
CFHY05	索塔纳/SONATA 1.6L/2.0L	2015-2018	110
CFHY20	雅绅特/ACCENT	2007-2010	110
CFHY14	雅绅特/ACCENT	2015-2017	111
CFHY23	途胜/TUCSON	2005-2008	111
CFHY11	途胜/TUCSON	2011-2015	111
CFHY24	途胜/TUCSON	2016-2019	111
CFHY17	胜达 (水箱)/SANTA FE (RAD FAN)	2001-2005	112
CFHY21	胜达 (冷气)/SANTA FE (COND FAN)	2001-2005	112
CFHY25	胜达/SANTA FE	2007-2009	112
CFHY09	胜达/SANTA FE L4 2.0L	2019-2020	112
CFHY12	锐欧 (水箱)/RIO (RAD FAN)	2003-2005	113
CFHY26	锐欧 (冷气)/RIO (COND FAN)	2003-2005	113
CFHY27	赛拉图 (水箱)/CERATO (RAD FAN)	2005-2009	113
CFHY22	赛拉图 (冷气)/CERATO (COND FAN)	2005-2009	113
CFHY03	领动/ELANTRA	2017-2019	114
CFHY28	起亚/PICANTO (JA)	2017-	114



**适用丰田系列 FOR TOYOTA SERIES**

水箱 Radiator Assembly

工厂编号 COMPANY NO	车型 MODEL	年份 YEAR	适用变速器类型 TRANSMISSION TYPE	页码 PAGE
RAA053-1	威驰/VIOS AXP41	2003-2005	16mm-MT	116
RAA054-1	威驰/VIOS AXP41	2003-2005	16mm-AT	116
RAA002-1	威驰/雅力士/VIOS 1.3 水箱	2009-2013	16mm-MT	116
RAA003-1	威驰/雅力士/VIOS 1.3 水箱	2009-2013	16mm-AT	116
RAA011-1	威驰/雅力士/VIOS 1.6	2009-2013	16mm-MT	116
RAA012-1	威驰/雅力士/VIOS 1.6	2009-2013	16mm-AT	116
RAA034-1	威驰/致炫/VIOS NSP15 水箱	2013-2016	16mm-MT	116
RAA035-1	威驰/致炫/VIOS NSP15 水箱	2013-2016	16mm-AT	116
RAA004-1	霸道/PRADO 2700	2003-2007	16mm-MT	117
RAA086-1	霸道/PRADO 2700	2003-2007	16mm-AT	117
RAA093-2	霸道/PRADO GRJ120 4000 (26厚)	2003-2007	16mm-MT/AT	117
RAA009-1	花冠/COROLLA 1.8 ZZE122	2003-2006	16mm-MT	117
RAA010-1	花冠/COROLLA 1.8 ZZE122	2003-2006	16mm-AT	117
RAA015-1	花冠/COROLLA 1.6 ZRE120	2007-2013	16mm-MT	117
RAA016-1	花冠/COROLLA 1.6 ZRE120	2007-2013	16mm-AT	117
RAA013-1	卡罗拉/逸致/COROLLA ZRE152	2008-2018	16mm-MT	117
RAA014-1	卡罗拉/逸致/COROLLA ZRE152	2008-2018	16mm-AT	118
RAA072-1	卡罗拉/COROLLA 1.2T 17 ZRE181	2017	16mm-MT/AT	118
RAA082-1	卡罗拉/COROLLA 1.2T	2019-	16mm-MT/AT	118
RAA090-1	卡罗拉雷凌 双擎 油电混动/COROLLA HYBRID 1.8	2019-	16mm-MT/AT	118
RAA095-1	卡罗拉 混动/COROLLA HYBRID 1.8	2018	16mm-MT/AT	118
RAA042-1	锐志/REIZ GRX122	2006-2013	16mm-MT/AT	118
RAA043-1	皇冠/CROWN 2.5 (不带管)	2015-	16mm-MT/AT	118
RAA044-1	皇冠/CROWN GRS182	2006-2014	16mm-MT/AT	118
RAA060-1	皇冠/CROWN 2.0T (带管)	2015-	16mm-MT/AT	119
RAA055-1	汉兰达/HIGHLANDER 2.0T ASU50	2015-2020	16mm-MT/AT	119
RAA056-1	ASU/汉兰达/HIGHLANDER 2.7	2009-2014	16mm-AT	119
RAA057-1	汉兰达/HIGHLANDER 3.5	2009-2014	16mm-AT	119
RAA087-1	汉兰达/皇冠 陆放混动/HIGHLANDER HYBRID 2.5	2021-	16mm-MT/AT	119
RAA058-1	汉兰达/HIGHLANDER 3.5	2015-2021	16mm-MT/AT	119
RAA092-1	汉兰达 混动/HIGHLANDER HYBRID 2.5L	2022-	16mm-MT/AT	119
RAA061-1	凯美瑞/CAMRY ACV51	2012-2017	16mm-MT/AT	119
RAA061-C1	凯美瑞/CAMRY ACV51 加密	2012-2017	16mm-MT/AT	120
RAA063-1	凯美瑞/CAMRY ACV40 ES240	2006-2011	16mm-MT/AT	120
RAA077-1	凯美瑞/CAMRY AXVJR-H71	2018-	16mm-MT/AT	120
RAA091-1	凯美瑞混动/亚洲龙 混动/CAMRY HYBRID 2.5	2018-	16mm-MT/AT	120
RAA091-C1	凯美瑞混动/CAMRY HYBRID 加密	2018-	16mm-MT/AT	120
RAA065-1	佳美/CAMRY 2.4/ACV30	2003-2005	16mm-AT	120
RAA068-1	RAV4 ACA33/ACR50	2009-2012	16mm-MT	120
RAA069-1	RAV4 ACA33/ACR50	2009-2012	16mm-AT	120
RAA073-1	荣放/RAV4 ZSA42 2.0	2015-	16mm-MT/AT	121
RAA085-1	奕泽 C-HR/IZOA 2.0	2018-	16mm-MT/AT	121
RAA089-1	雷克萨斯/LEXUS ES350 (GSV40)	2009	16mm-MT/AT	121
RAA088-1	雷克萨斯/塞纳/LEXUS RX450H/RX350 GYL/GGL	2011	16mm-MT/AT	121
RAA094-1	威尔法 双擎 油电混合/VELLFIRE HYBRID 2.5	2020-	16mm-MT/AT	121

适用本田系列 FOR HONDA SERIES

水箱Radiator Assembly

工厂编号 COMPANY NO	车型 MODEL	年份 YEAR	适用变速器类型 TRANSMISSION TYPE	页码 PAGE
RAB001-1	滨智/VEZEL 1.5 RU1 (带管)	2015-	16mm-MT/AT	123
RAB002-1	滨智/VEZEL 1.8 RU5 (不带管)	2015-	16mm-MT/AT	123
RAB003-1	锋范/歌瑞GJ6/CITY (不带管)	2015-	16mm-MT	123
RAB004-1	锋范/歌瑞GJ6/CITY (带管)	2015-	16mm-AT	123
RAB010-1	雅阁/ACCORD 2.3 CG5	1998-2003	16mm-AT	123
RAB011-1	雅阁/ACCORD 2.4 CM5	2003-2006	16mm-AT	123
RAB013-1	雅阁/ACCORD 2.0 CP1//2.4 CP2	2008-2013	16mm-AT	123
RAB016-1	雅阁3.0/歌诗图3.5/ACCORD	2008-2013	16mm-AT	123
RAB017-1	雅阁/思铂睿/ACCORD CR1/2	2014-2017	16mm-MT/AT	124
RAB019-1	雅阁/ACCORD CV1	2018-	16mm-MT/AT	124
RAB059-1	雅阁混动/ACCORD HYBRID CR6	2014-2017	16mm-MT/AT	124
RAB018-1	思铂睿/SPIRIOR CU2	2011-2015	16mm-AT	124
RAB023-1	思域/思铭/CIVIC 1.8	2006-2011	16mm-MT	124
RAB024-1	思域/CIVIC FB2	2012-2015	16mm-MT/AT	124
RAB026-1	思域/缤智/CIVIC 1.5T FC1	2016-	16mm-MT/AT	124
RAB065-1	思域/CIVIC FE1/FE3	2022-	16mm-MT/AT	124
RAB029-1	杰德/JADE FR1	2013-2017	16mm-MT	125
RAB030-1	飞度两厢/FIT GD1	2003-2006	16mm-MT	125
RAB031-1	飞度两厢/FIT GD1	2003-2006	16mm-AT	125
RAB032-1	飞度三厢/理念/FIT GD6	2006-2008	16mm-MT	125
RAB033-1	飞度三厢/理念/FIT GD6	2006-2007	16mm-AT	125
RAB034-1	飞度/FIT GK4 (不带管)	2014-2019	16mm-MT	125
RAB035-1	飞度/FIT GK4 (带管)	2014-2019	16mm-AT	125
RAB036-1	飞度/FIT 1.3/1.5	2009-2013	16mm-MT	125
RAB064-1	飞度/FIT 1.5L GR9/GS1	2021-	16mm-MT/AT	126
RAB037-1	飞度GE6/锋范/FIT 1.5	2009-2013	16mm-AT	126
RAB038-1	锋范/凌派/CITY 1.8 GM3	2009-2014	16mm-MT/AT	126
RAB040-1	奥德赛/ODYSSEY RA6	2002-2004	16mm-MT/AT	126
RAB041-1	奥德赛/ODYSSEY RB1	2005-2008	16mm-AT	126
RAB041-C1	奥德赛/ODYSSEY RB1 (加密)	2005-2008	16mm-AT	126
RAB042-1	奥德赛/ODYSSEY RB3	2009-2013	16mm-AT	126
RAB044-1	奥德赛/ODYSSEY RC3/RR8	2014-	16mm-MT/AT	126
RAB063-1	奥德赛/ODYSSEY RC4	2019-	16mm-MT/AT	127
RAB047-1	CRV/RD5	2007-2011	16mm-AT	127
RAB049-1	CRV/2.0 RE2	2007-2011	16mm-AT	127
RAB049-C1	CRV/2.0 RE2 (加密)	2007-2011	16mm-AT	127
RAB050-1	CRV/2.4 RE4	2007-2011	16mm-AT	127
RAB051-1	CRV/RM4	2012-2016	16mm-MT/AT	127
RAB056-1	CRV	2017-	16mm-MT/AT	127
RAB067-1	CR-V/皓影 混动 2.0 RT5	2020-	16mm-MT/AT	127
RAB054-1	艾力绅/ELYSION RR7	2006-2014	16mm-AT	128
RAB057-1	冠道/AVANCIER 1.5T TG1 (带管)	2017-	16mm-MT/AT	128
RAB058-1	冠道/AVANCIER 2.0 TG2 (不带管)	2017-	16mm-MT/AT	128
RAB062-1	凌派/CRIDER 1.0T FS1	2019-	16mm-AT	128
RAB068-1	凌派1.5L混动/享域/CRIDER FS2/FS5	2020-	16mm-MT/AT	128
RAB014-1	歌诗图/CROSSTOUR GST 2.4 TF3	2011	16mm-MT/AT	128



**适用日产系列 FOR NISSAN SERIES**

水箱 Radiator Assembly

工厂编号 COMPANY NO	车型 MODEL	年份 YEAR	适用变速器类型 TRANSMISSION TYPE	页码 PAGE
RAC001-1	颐达/骐达/轩逸/骊威/俊逸/TIIDA/SYLPHY 1.8	2005-2010	16mm-AT	129
RAC002-1	颐达/骐达/轩逸/TIIDA/SYLPHY	2005-2010	16mm-MT	129
RAC003-1	骐达/TIIDA 1.6T	2011-2014	16mm-MT/AT	129
RAC004-1	蓝鸟/风神/BLUE BIRD U13	2005-	16mm-AT	129
RAC005-1	天籁/ALTIMA 2.0 J31	2003-2007	16mm-AT	129
RAC006-1	天籁/ALTIMA 2.3/2.5 J31	2004-2007	16mm-AT	129
RAC008-1	天籁/ALTIMA J32	2008-2012	16mm-AT	129
RAC009-1	天籁/ALTIMA L33	2013-2018	16mm-MT/AT	129
RAC059-1	天籁/ALTIMA	2019	16mm-MT	130
RAC068-1	启辰 电动/VEUCIA D60 EV	2019-	16mm-MT/AT	130
RAA064-1	启辰 自动/手动/VEUCIA T90 2.0 (不带小水管)	2016	16mm-MT/AT	130
RAC010-1	N16/阳光/SUNNY 2.0	2003-2006	16mm-AT	130
RAC030-1	阳光/N17玛驰 /SUNNY	2010-2013	16mm-MT	130
RAC012-1	帅客 1.5/御轩2.0 /CDV	2009	16mm-MT	130
RAC013-1	帅客/CDV 1.6	2009	16mm-MT	130
RAC014-1	皮卡ZD25/Y37/锐琪 2.4	2013	16mm-MT	130
RAC016-1	皮卡P31	/	16mm-MT	131
RAC032-1	皮卡P27/ZG24/锐琪 3.0	/	16mm-MT	131
RAC023-1	皮卡D22/帕拉丁	/	16mm-MT	131
RAC020-2	逍客/QASHQAI 1.6	2007-2014	26mm-MT/AT	131
RAC021-2	逍客/QASHQAI J10 2.0	2007-2014	26mm-MT/AT	131
RAC022-2	逍客/QASHQAI (不带水管)	2007-2014	26mm-MT/AT	131
RAC047-1	逍客/QASHQAI 1.2T (不带管)	2015-	16mm-MT/AT	131
RAC048-1	逍客/QASHQAI 2.0 (带管)	2015-	16mm-MT/AT	131
RAC064-1	逍客 通装版/QASHQAI J10	2008	16mm-MT/AT	132
RAC031-1	奇骏/ROGUE 2.0/2.5 T31	2008-2013	16mm-MT	132
RAC038-1	奇骏/ROGUE 2.5 T32	2014-2018	16mm-AT	132
RAC039-1	奇骏/ROGUE 2.0 T32	2014-2018	16mm-MT	132
RAC069-1	奇骏/ROGUE T33 2.5	2019-	16mm-MT/AT	132
RAC035-1	轩逸 蓝鸟/SYLPHY B17/15	2012-2018	16mm-MT/AT	132
RAC062-1	轩逸/SYLPHY B18	2019-	16mm-MT/AT	132
RAA067-1	轩逸 纯电动/SYLPHY	2019-	16mm-MT/AT	132
RAC036-1	NV200 MT	2010-2018	16mm-MT	133
RAC041-1	风度/CEFIRO A33	2004-2006	16mm-MT/AT	133
RAC043-1	ZD22/奥丁/OTING 2.5T	2013-	16mm-MT/AT	133
RAC045-1	ZD25	2019-	16mm-MT	133
RAC054-1	T70 1.6/2.0//VEUCIA T70	/	16mm-MT	133
RAC063-1	骊威/LIVINA	2005-2010	16mm-MT/AT	133
RAA049-1	楼兰/贵士/MURANO 3.5	2008-2014	16mm-MT/AT	133
RAA050-1	楼兰/MURANO	2015-	16mm-MT/AT	133
RAA068-32	途乐/PATROL Y62	2010-2014	32mm-MT/AT	134
RAA055-2	途乐/PATROL Y61 TB45	2000-2009	26mm-MT/AT	134
RAC034-1	劲客/KICKS 1.5L	2017-	16mm-MT/AT	134

适用马自达系列 FOR MAZDA SERIES

水箱Radiator Assembly

工厂编号 COMPANY NO	车型 MODEL	年份 YEAR	适用变速器类型 TRANSMISSION TYPE	页码 PAGE
RAE001-1	马自达6/MAZDA 6	2003-2005	16mm-MT/AT	135
RAE002-1	马自达6/MAZDA 6 B70	2005-2013	16mm-AT	135
RAE003-1	马自达6/MAZDA 6 B70	2005-2013	16mm-MT	135
RAE009-1	奔腾/BESTURN B50	2013-2014	16mm-MT/AT	135
RAE036-1	奔腾/BESTURN B50F	2014-2015	16mm-MT/AT	135
RAE006-1	马自达/MAZDA CX-7	2015	16mm-AT	135
RAE035-1	马自达/MAZDA CX-4	2016	16mm-MT/AT	135
RAE005-1	马自达/MAZDA CX-5	/	16mm-MT	135
RAE031-1	长安M2/嘉年华/CHANA M2/FIESTA	2008	16mm-MT	136
RAE007-1	长安M3/福克斯	/	16mm-MT/AT	136
RAE030-1	长安M2/嘉年华/CHANA M2/FIESTA	2009	16mm-AT	136

**适用丰田系列 FOR TOYOTA SERIES**

冷凝器 Condenser Assembly

工厂编号 COMPANY NO	车型 MODEL	年份 YEAR	页码 PAGE
JR-LNQ-T017	凯美瑞/CAMRY ACV40	2006-2011	138
JR-LNQ-T075	凯美瑞 混动/CAMRY HYBRID	2007-2011	138
JR-LNQ-T057	凯美瑞 混动/ES300H/CAMRY	2012	138
JR-LNQ-T033	凯美瑞/CAMRY ACV51//雷克萨斯/LEXUS ES250	2012-2017	138
JR-LNQ-T063	凯美瑞/CAMRY//雷克萨斯/LEXUS ES200	2018-	138
JR-LNQ-T021	卡罗拉/COROLLA ZRE152	2008-2015	138
JR-LNQ-T059	卡罗拉 混动/COROLLA HYBRID 1.8	2016	138
JR-LNQ-T065	卡罗拉/COROLLA 1.2T	2016	138
JR-LNQ-T073	卡罗拉/COROLLA	2019-	139
JR-LNQ-T027	皇冠/CROWN GRS182	2006-2014	139
JR-LNQ-T077	皇冠/CROWN 2.5	2015-2019	139
JR-LNQ-T061	皇冠/CROWN 2.0T	2015-2019	139
JR-LNQ-T007	花冠/COROLLA ZZE122/F3	2003-2006	139
JR-LNQ-T019	花冠/COROLLA ZRE120	2007-2013	139
JR-LNQ-T023	汉兰达/HIGHLANDER CSU4# 2.7/3.5	2009-2014	139
JR-LNQ-T055	汉兰达/HIGHLANDER	2015-2020	139
JR-LNQ-T076	汉兰达 双擎/皇冠陆放 混动/HIGHLANDER HYBRID 2.5	2021-	140
JR-LNQ-T029	霸道/PRADO 4000 GRJ120 (单空调)	2003-2009	140
JR-LNQ-T035	霸道/PRADO 2700 RZJ120 (双空调)	2003-2009	140
JR-LNQ-T074	普拉多/PRADO GRJ150	2009-2015	140
JR-LNQ-T025	RAV4 ACA33/ACR50	2008-2012	140
JR-LNQ-T045	RAV4	2013-2019	140
JR-LNQ-T071	奕泽/C-HR/IZOA	2018-	140
JR-LNQ-T005	威驰/金刚/新款/VIOS	2004-2005	140
JR-LNQ-T009	威驰/VIOS	2006-2007	141
JR-LNQ-T013	雅力士/威驰/YARIS/VIOS 1.6	2008-2013	141
JR-LNQ-T011	雅力士/威驰/YARIS/VIOS 1.3	2008-2013	141
JR-LNQ-T051	威驰/VIOS	2014-	141
JR-LNQ-T015	锐志/REIZ GRX122	2006-2014	141
JR-LNQ-T078	雷克萨斯/LEXUS RX270/RX350	2011	141
JR-LNQ-T079	雷克萨斯/LEXUS GS350/GS250	2011	141

**适用本田系列 FOR HONDA SERIES**

冷凝器 Condenser Assembly

工厂编号 COMPANY NO	车型 MODEL	年份 YEAR	页码 PAGE
JR-LNQ-H005	雅阁/ACCORD CM5/CM6	2003-2007	143
JR-LNQ-H019	雅阁/歌诗图/ACCORD CP1/CP2	2008-2013	143
JR-LNQ-H074	雅阁 混动/ACCORD HYBRID CR6	2014	143
JR-LNQ-H049	雅阁/ACCORD CR1/2	2014-2017	143
JR-LNQ-H076	雅阁/ACCORD CV1	2018	143
JR-LNQ-H017	思域/CIVIC FA1	2006-2011	143
JR-LNQ-H037	思域/CIVIC FB2	2012-2015	143
JR-LNQ-H065	思域/CIVIC FC1	2016-2020	143
JR-LNQ-H080	思域/CIVIC	2022	144
JR-LNQ-H033	思铂睿/SPIRIOR CU2	2009-2015	144
JR-LNQ-H045	凌派/CRIDER 1.8/GJ5	2013-2018	144
JR-LNQ-H078	凌派/CRIDER	2019	144
JR-LNQ-H081	凌派 混动/CRIDER HYBRID 1.5	2020	144
JR-LNQ-H041	理念/EVERUS G11	2009-2012	144
JR-LNQ-H059	理念/EVERUS	2012-2014	144
JR-LNQ-H047	杰德/JADE 1.8	2013-2017	144
JR-LNQ-H072	杰德/JADE FR2	2018	145
JR-LNQ-H067	冠道/AVANCIER 2.0	2017	145
JR-LNQ-H021	锋范/CITY GM2/GM3	2009-2014	145
JR-LNQ-H061	锋范/哥瑞/CITY	2015	145
JR-LNQ-H007	飞度两厢/FIT GD1	2003-2005	145
JR-LNQ-H009	飞度三厢/FIT GD6	2006-2008	145
JR-LNQ-H029	飞度/FIT GE6	2009-2013	145
JR-LNQ-H057	飞度/FIT GK5	2014-2019	145
JR-LNQ-H079	飞度/FIT 1.5L GR9/GS1	2021	146
JR-LNQ-H053	缤智/RU/XR-V/1.5/1.8	2013-2020	146
JR-LNQ-H003	奥德赛/ODYSSEY RA6	2002-2005	146
JR-LNQ-H001	奥德赛/ODYSSEY RB1	2006-2008	146
JR-LNQ-H015	奥德赛/ODYSSEY RB3	2009-2013	146
JR-LNQ-H055	奥德赛/ODYSSEY RC3	2014	146
JR-LNQ-H011	CRV RD5	2003-2006	146
JR-LNQ-H027	CRV RE2/RE4	2007-2011	146
JR-LNQ-H035	CRV RM4	2012-2016	147
JR-LNQ-H070	CRV RW1/2	2017	147
JR-LNQ-H051	艾力绅/ELYSION	2013-2015	147

适用日产系列 FOR NISSAN SERIES

冷凝器 Condenser Assembly

工厂编号 COMPANY NO	车型 MODEL	年份 YEAR	页码 PAGE
JR-LNQ-N62	阳光/SUNNY N16	2003-2009	149
JR-LNQ-N031	阳光/玛驰/SUNNY N17	2010-2013	149
JR-LNQ-N046	轩逸/SYLPHY B17	2006-2011	149
JR-LNQ-N59	轩逸 电动/SYLPHY	2018	149
JR-LNQ-N054	劲客/轩逸/SYLPHY	2019	149
JR-LNQ-N003	颐达/骐达/轩逸/启辰/TIIDA/SYLPHY/VEUCIA	2006-2011	149
JR-LNQ-N048	骐达/TIIDA 1.6T	2013	149
JR-LNQ-N033	奇骏/ROGUE T31	2008-2013	149
JR-LNQ-N052	奇骏/ROGUE T32	2014-2019	150
JR-LNQ-N025	逍客/QASHQAI J10	2007-2014	150
JR-LNQ-N035	逍客/QASHQAI	2015-2018	150
JR-LNQ-N009	天籁/ALTIMA J31	2004-2007	150
JR-LNQ-N019	天籁/ALTIMA J32	2008-2012	150
JR-LNQ-N058	天籁/ALTIMA L34	2019	150
JR-LNQ-N039	启辰/VEUCIA T70/T90	2017-2019	150
JR-LNQ-N61	楼兰/贵士/MURANO 3.5	2008-2014	150
JR-LNQ-N60	楼兰/MURANO	2015	151
JR-LNQ-N007	蓝鸟/风神/BLUE BIRD U13/小口	2006-2011	151
JR-LNQ-N005	蓝鸟/风神/BLUE BIRD U13/大口	2006-2011	151

适用马自达系列 FOR MAZDA SERIES

冷凝器 Condenser Assembly

工厂编号 COMPANY NO	车型 MODEL	年份 YEAR	页码 PAGE
JR-LNQ-M005	一汽/M6/奔腾/MAZDA 6	2006-2012	152
JR-LNQ-M008	睿翼/MAZDA 6	2010	152

**适用丰田系列 FOR TOYOTA SERIES**

中冷器Intercooler Assembly

工厂编号 COMPANY NO	车型 MODEL	年份 YEAR	页码 PAGE
JR-ZLT001	卡罗拉/雷凌/COROLLA 1.2T	2016-2018	154
JR-ZLT002	汉兰达/HIGHLANDER 2.0T	2015-	154
JR-ZLT003	卡罗拉/雷凌/COROLLA 1.2T	2019-	154
JR-ZLT005	雷克萨斯/LEXUS NX200T AGZ10	2015-	154
JR-ZLT004	皇冠/CROWN 2.0T	2015-2017	154
JR-ZLT006	雷克萨斯/LEXUS IS200T 2.0T	2016-	154
JR-ZLT007	雷克萨斯/LEXUS RX200/300 2.0T	2016-	154
JR-ZLT008	卡罗拉/雷凌 混动/COROLLA HYBRID	2015-2017	154

**适用本田系列 FOR HONDA SERIES**

中冷器Intercooler Assembly

工厂编号 COMPANY NO	车型 MODEL	年份 YEAR	页码 PAGE
JR-ZLH001	思域/CIVIC 1.5T	2016-2021	155
JR-ZLH009	思域/CIVIC 1.5T	2022-	155
JR-ZLH002	杰德/JADE 1.5T	2017-2019	155
JR-ZLH003	缤智/VEZEL XRV 1.5T	2019-	155
JR-ZLH004	冠道/AVANCIER URV 1.5T	2017-	155
JR-ZLH005	冠道/AVANCIER URV 2.0T	2017-	155
JR-ZLH006	CRV 1.5T	2017-	155
JR-ZLH007	凌派/享誉/CRIDER 1.0T	2019-	155
JR-ZLH008	10代雅阁/10TH GEN ACCORD 1.5T	2018-	155

**适用日产系列 FOR NISSAN SERIES**

中冷器Intercooler Assembly

工厂编号 COMPANY NO	车型 MODEL	年份 YEAR	页码 PAGE
JR-ZLN001	天籁/ALTIMA	2019-	156



适用丰田系列 FOR TOYOTA SERIES

鼓风机-Heater Blower Motor

工厂编号 COMPANY NO	车型 MODEL	年份 YEAR	OE编码 OE#	页码 PAGE
JR-BLT001	卡罗拉/COROLLA	2008-2019	87103-02180/02700	158
	RAV4	2008-2019		
	雷凌/LEVIN (双插)	2014-2018		
JR-BLT002	卡罗拉/COROLLA	2008-2019	87103-02190/0R020	158
	RAV4	2008-2019		
	雷凌/LEVIN (三插)	2014-2018		
JR-BLT003	凯美瑞/CAMRY	2006-2017	87103-06090/0E070	158
	汉兰达/HIGHLANDER	2009-2020		
	霸道/PRADO 150	2010-2019		
	雷克萨斯/LEXUS GX460	2009-2021		
JR-BLT004	4RUNNER	2009-2021	87103-60330/60360	158
	霸道/PRADO 120	2007-2009		
	雷克萨斯/LEXUS GX470	2007-2009		
JR-BLT005	霸道/PRADO 120	2003-2006	87103-35040/35050 /35060/35080	159
	4RUNNER	2002-2005		
	雷克萨斯/LEXUS GX470	2003-2006		
JR-BLT006	佳美/CAMRY 2.4	2002-2005	87103-33081/33071	159
	雷克萨斯 ES系列/LEXUS ES SERIES	2001-2005		
JR-BLT007	皇冠/CROWN	2006-	87103-0N010/0N011 /60390/60480/60481 /60560/30450/30451 /48080/50100	159
	锐志/REIZ/MARK-X	2006-2013		
	陆巡/LANG CRUISER 200	2007-2019		
	雷克萨斯 LX系列/LEXUS LX SERIES	2007-2015		
	雷克萨斯 IS/GS系列/LEXUS IS/GS SERIES	2006-2015		
	雷克萨斯 RX系列/LEXUS RX SERIES	2008-2015		
	雷克萨斯 ES系列/LEXUS RS SERIES	2006-2012		
雷克萨斯 LS系列/LEXUS LS SERIES	2006-2010			
雷克萨斯 CT系列/LEXUS CT SERIES	2011-2021			
JR-BLT008	花冠/COROLLA	2003-2006	87103-12070/02070 /02050/02370	159
	AVENSIS	2003-2008		
	美版卡罗拉/COROLLA USA MODEL	2003-2006		
	美版MATRIX/MATRIX USA MODEL	2003-2007		
JR-BLT009	花冠EX/COROLLA	2007-2013	87103-02220/02221/02500	160
JR-BLT010	威驰/VIOS	2003-2007	87103-0D040	160
JR-BLT011	威驰/VIOS	2008-2013	87103-0D100/0D170 /52141/52140	160
	雅力士/YARIS	2009-2013		
JR-BLT012	威驰/VIOS	2014-2021	87103-0D270/0D340	160
	雅力士致炫/YARIS L	2014-2021		
JR-BLT013	卡罗拉/COROLLA	2020-	87103-F4060/02650	161
	RAV4	2020-		
	亚洲龙/AVALON	2019-		
	奕泽/IZOA	2018-		
	亚洲狮/ALLION/CHINA MODEL	2021-		
JR-BLT014	凯美瑞/CAMRY	2018-	87103-06130	161
	雷凌/LEVIN	2019-		
	C-HR	2018-		
	威兰达/WILDLANDER	2020-		
	凌尚/LEVIN GT	2021-		
JR-BLT015	陆巡/LANG CRUISER 100	1998-2006	87103-60250	161
	雷克萨斯/LEXUS LX470	1998-2006		

适用本田系列 FOR HONDA SERIES

鼓风机 Heater Blower Motor

工厂编号 COMPANY NO	车型 MODEL	年份 YEAR	OE编码 OE#	页码 PAGE
JR-BLH001	雅阁/ACCORD	2008-2013	79310-TB0-H11	163
	歌诗图/CROSSTOUR	2011-2016		
	思铂睿/SPIRIOR	2010-2014		
JR-BLH002	CR-V	2007-2011	79310-SWW-G01	163
JR-BLH003	奥德赛/ODYSSEY	2006-2013	79310-SFJ-W01	163
JR-BLH004	CR-V	2012-2016	79310-T0T-H01	163
	杰德/JADE	2013-		
	艾力绅/ELYSION	2016-		
	奥德赛/ODYSSEY	2014-		
JR-BLH005	雅阁/ACCORD	2014-2017	79310-T2J-H01	164
	思铂睿/SPIRIOR	2015-2017		
JR-BLH006	雅阁/ACCORD	2018-	79310-TET-H51 79310-TVE-H01	164
	英仕派/INSPIRE	2019-		
	思域/CIVIC	2016-		
JR-BLH007	锋范/CITY	2009-2014	79310-TMO-G01 79310-TF0-G01	164
	飞度/FIT/JAZZ	2009-2013		
JR-BLH008	锋范/CITY	2015-2020	79310-T5H-H01 79310-T7J-H01	164
	飞度/FIT/JAZZ	2014-2020		
	哥瑞/GREIZ	2016-		
	竞瑞/GIENIA	2017-		
	缤智/VEZEL	2014-2021		
	XR-V	2014-2021		
	凌派/CRIDER	2015-2018		
JR-BLH009	思域/CIVIC	2006-2011	79310-SNK-A01 79310-SNA-A01	165
	思铭/CIIMO	2012-2016		
JR-BLH010	思域/CIVIC	2012-2015	79310-TS6-H01	165
JR-BLH011	雅阁/ACCORD	1998-2002	79310-S84-A01	165
JR-BLH012	雅阁/ACCORD	2003-2007	79310-SDG-000	165
JR-BLH013	飞度/FIT/JAZZ	2003-2008	79310-SAA-G01	166
	思迪/CITY	2007-2008		
	理念 S1/EVERUS S1	2011-		
JR-BLH014	CR-V	2002-2006	79310-S7A-G12	166
	时韵/STREAM	2001-2005		
JR-BLH015	CR-V/皓影/BREEZE	2017-	79310-TLA-A51	166
JR-BLH016	凌派/CRIDER/享域/ENVIX	2019-	79310-TBT-H01	166



**适用日产系列 FOR NISSAN SERIES**

鼓风机-Heater Blower Motor

工厂编号 COMPANY NO	车型 MODEL	年份 YEAR	OE编码 OE#	页码 PAGE	
JR-BLN001	骐达/颐达/TIIDA	2006-2010	27226-EE91A/ED50A	167	
	轩逸/SYLPHY/SENTRA	2006-2011			
	骊威/骏逸/LIVINA	2006-2011			
	JR-BLN002	NV200	2010-2018	27200-2FJ0A	167
		启辰/VEUCIA D50	2012-2016		
		启辰/VEUCIA R50	2012-2016	27226-2DU1B	167
		经典轩逸/SYLPHY/SENTRA	2012-2016		
骊威/LIVINA		2013-2016			
JR-BLN003	骐达/TIIDA	2011-	27226-3DF0A/3RA0A /4AF1A/5MA1A	167	
	轩逸/SYLPHY	2013-2019			
	蓝鸟/LANNIA	2016-			
JR-BLN004	轩逸/SYLPHY/SENTRA	2020-	27226-6LA0A	167	
JR-BLN005	天籁/TEANA/ALTIMA	2004-2007	27220-9W100	167	
JR-BLN006	天籁/TEANA/ALTIMA	2008-2018	27225-JK61A/JK60B /3TA1A/3TA0A /JK00A/JN00A	168	
	楼兰/MURANO	2015-2018			
	西玛/MAXIMA	2016-			
	贵士/QUEST	2013-2017			
	英菲尼迪/INFINITI Q50L	2014-2018			
	英菲尼迪/INFINITI QX50	2015-2017			
	英菲尼迪 EX/FX/G系列/INFINITI EX/FX/G SERIES	2008-2013			
	英菲尼迪/INFINITI Q50	2014-2016			
	英菲尼迪/INFINITI Q60	2013-2014			
	英菲尼迪/INFINITI QX50	2013-2014			
英菲尼迪/INFINITI QX60	2014-2016				
英菲尼迪/INFINITI QX70	2013-2017				
JR-BLN007	天籁/ALTIMA	2019-	27220-5NN0A/5NN1A	168	
	英菲尼迪/INFINITI QX50	2018-			
JR-BLN008	阳光/SUNNY	2004-2009	27226-8M500	168	
JR-BLN009	阳光/SUNNY	2010-2016	27226-1HM0A	168	
	玛驰/MARCH	2010-2015	/3AW1B/6W80A		
JR-BLN010	逍客/QASHQAI	2008-2013	27226-JE20A/EN000	169	
	奇骏/X-TRAIL ROGUE	2008-2013	/ET00A/JD00A		
JR-BLN011	奇骏/X-TRAIL ROGUE	2014-2010	27226-4BC0A	169	
JR-BLN012	逍客/QASHQAI ROGUE SPORT	2015-2020	27226-DF30A	169	
JR-BLN013	途乐/PATROL	2012-	27220-JK00A/JK00C /JK00D/JK01A	169	
	英菲尼迪/INFINITI QX80	2011-			
	英菲尼迪/INFINITI QX56	2011-2013			
JR-BLN014	途达/TERRA	2018-	27220-4JG0A/4JA0A	170	
	纳瓦拉/NAVARA NP300	2015-			





# 电子风扇

## Cooling Fan Assembly



**大功率 / 高转速 / 强冷却**

**HIGH POWER / HIGH SPEED / STRONG COOLING**

奥迪AUDI .....	26-32
丰田TOYOTA .....	33-52
雷克萨斯LEXUS .....	53-56
传祺TRUMPCHI.....	57-58
本田HONDA .....	59-82
日产NISSAN .....	83-96
马自达MAZDA .....	97-104

大众VOLKSAGEN .....	105-108
现代起亚HYUNDAI/KIA .....	109-114

## 适用**奥迪**系列 FOR AUDI SERIES

奥迪/AUDI A6L 2.0T 2.4L 2.8L 3.0L 3.2L

2005-2012



OE 4F0959455A CFAC01

OE

OE

OE

**适用车型/APPLICATION :**  
2005-2012款 奥迪A6L  
/AUDI A6L 2.0T 2.4L 2.8L 3.0L 3.2L

奥迪/AUDI A6L 2.0T 2.4L 2.8L 3.0L 3.2L

2005-2012



OE 4F0959455 CFAC02

OE

OE

OE

**适用车型/APPLICATION :**  
2005-2012款 奥迪A6L  
/AUDI A6L 2.0T 2.4L 2.8L 3.0L 3.2L

奥迪 (主) /AUDI A3 1.6L

2006-2013



OE 1K0959455P/1K0959455DT CFAC09  
1K0959455J/3C0959455FJ

OE

OE

OE

**适用车型/APPLICATION :**  
2006-2013款 奥迪 (主) /AUDI A3 1.6L  
2008-2015款 奥迪/AUDI TT 1.4T

奥迪 (副) /AUDI A3 1.6L

2006-2013



OE 1K0959455DG/1K0959455DH CFAC12  
1K0959455ET/3C0959455G

OE

OE

OE

**适用车型/APPLICATION :**  
2006-2013款 奥迪 (副) /AUDI A3 1.6L  
2008-2015款 奥迪/AUDI TT 1.4T

总成/ASSEMBLY

扇框/FAN-SHROUD

扇叶/FAN-BLADE

电机/FAN-MOTOR

奥迪 (双风扇) /AUDI A3 1.6L

2006-2013



OE 1K0121205AD/1K0959455N KINFOR NO: CFAC13

OE KINFOR NO:

OE KINFOR NO:

OE KINFOR NO:

适用车型/APPLICATION :

2006-2013款 奥迪 (双风扇) /AUDI A3 1.6L  
2008-2015款 奥迪/AUDI TT 1.4T

奥迪/ AUDI A4L

2009-2016



OE 8K0959455K KINFOR NO: CFAC03

OE KINFOR NO:

OE KINFOR NO:

OE KINFOR NO:

适用车型/APPLICATION :

2009-2016款 奥迪/ AUDI A4L  
2009-2013款 奥迪/ AUDI Q5

奥迪/ AUDI A4L

2009-2016



OE 8K0959455M KINFOR NO: CFAC04

OE KINFOR NO:

OE KINFOR NO:

OE KINFOR NO:

适用车型/APPLICATION :

2009-2016款 奥迪/ AUDI A4L  
2009-2013款 奥迪/ AUDI Q5

奥迪/AUDI A4 2.0T

2015-



OE 8W0959455F/8W0959455C KINFOR NO: CFAC15  
8W0959455M/8W0121003B  
L80D121003

OE KINFOR NO:

OE KINFOR NO:

OE KINFOR NO:

适用车型/APPLICATION :

2015款 奥迪/AUDI A4 2.0T

总成/ASSEMBLY

扇框/FAN-SHROUD

扇叶/FAN-BLADE

电机/FAN-MOTOR

## 奥迪/AUDI Q5L/C8/C9

2016



OE 80D-121-003 KINFOR NO: CFAC05

OE KINFOR NO:

OE KINFOR NO:

OE KINFOR NO:

适用车型/APPLICATION :  
2016款 奥迪/AUDI Q5L/C8/C9

## 奥迪/AUDI A4L 2.0TFS/3.2FSI//Q5 2.0TFS

2008-2016



OE 8K0121207A KINFOR NO: CFAC06

OE KINFOR NO:

OE KINFOR NO:

OE KINFOR NO:

适用车型/APPLICATION :  
2008-2016款 奥迪/AUDI A4L 2.0TFS/3.2FSI  
2008-2016款 奥迪/AUDI Q5 2.0TFS

## 奥迪 (主) /AUDI A6 2.4L

2005-2011



OE 4F0959455/8E0959455K KINFOR NO: CFAC16

OE KINFOR NO:

OE KINFOR NO:

OE KINFOR NO:

适用车型/APPLICATION :  
2005-2011款 奥迪 (主) /AUDI A6 2.4L  
2004-2008款 奥迪/AUDI A4 1.8T

## 奥迪 (副) /AUDI A6 2.4L

2005-2011



OE 4F0959455A/8E0959455M  
8E0959455N/8E0959455C KINFOR NO: CFAC11

OE KINFOR NO:

OE KINFOR NO:

OE KINFOR NO:

适用车型/APPLICATION :  
2005-2011款 奥迪 (副) /AUDI A6 2.4L  
2004-2008款 奥迪/AUDI A4 1.8T

总成/ASSEMBLY

扇框/FAN-SHROUD

扇叶/FAN-BLADE

电机/FAN-MOTOR

奥迪 V6/AUDI A6 3.0L

2012-2018



OE 4H0121207B/4H0959455M KINFOR NO: CFAC07

OE KINFOR NO:

OE KINFOR NO:

OE KINFOR NO:

适用车型/APPLICATION :  
2012-2018款 奥迪/AUDI A6 3.0L

奥迪 (主) /AUDI A7 2.0L

2012-2018



OE 4H0959455AD KINFOR NO: CFAC14

OE KINFOR NO:

OE KINFOR NO:

OE KINFOR NO:

适用车型/APPLICATION :  
2012-2018款 奥迪 (主) /AUDI A7 2.0L

奥迪 (副) /AUDI A7 2.0L

2012-2018



OE 4H0959455AE KINFOR NO: CFAC10

OE KINFOR NO:

OE KINFOR NO:

OE KINFOR NO:

适用车型/APPLICATION :  
2012-2018款 奥迪 (副) /AUDI A7 2.0L

奥迪 (主) /AUDI A8 3.0T

2010-2017



OE 4H0959455AB/4H0959455R KINFOR NO: CFAC18

OE KINFOR NO:

OE KINFOR NO:

OE KINFOR NO:

适用车型/APPLICATION :  
2010-2017款 奥迪 (主) /AUDI A8 3.0T

总成/ASSEMBLY

扇框/FAN-SHROUD

扇叶/FAN-BLADE

电机/FAN-MOTOR

## 奥迪 (副) /AUDI A8 3.0T

2010-2017



OE 4H0959455AC KINFOR NO: CFAC08

OE KINFOR NO:

OE KINFOR NO:

OE KINFOR NO:

适用车型/APPLICATION :  
2010-2017款 奥迪 (副) /AUDI A8 3.0T

## 奥迪 (主) /AUDI Q5 2.5L

2009-2015



OE 8K0959455G/8K0959455K KINFOR NO: CFAC19

OE KINFOR NO:

OE KINFOR NO:

OE KINFOR NO:

适用车型/APPLICATION :  
2009-2015款 奥迪 (主) /AUDI Q5 2.5L  
2012-2016款 奥迪/AUDI A6 2.0T  
2014-2016款 奥迪 /AUDI A7 2.0T  
2008-2015款 奥迪/AUDI A4 2.5L  
2008-2015款 奥迪 /AUDI A5 2.5L  
2015-2017款 奥迪 /AUDI Q3 2.0L

## 奥迪 (副) /AUDI Q5 2.5L

2009-2015



OE 8K0959455F/8K0959455M KINFOR NO: CFAC17

OE KINFOR NO:

OE KINFOR NO:

OE KINFOR NO:

适用车型/APPLICATION :  
2009-2015款 奥迪 (副) /AUDI Q5 2.5L  
2012-2016款 奥迪/AUDI A6 2.0T  
2014-2016款 奥迪 /AUDI A7 2.0T  
2008-2015款 奥迪/AUDI A4 2.5L  
2008-2015款 奥迪 /AUDI A5 2.5L  
2015-2017款 奥迪/AUDI Q3 2.0L

## 奥迪 (主) /AUDI Q7 3.0T

2007-2011



OE 7L0959455G/7L0959455D KINFOR NO: CFAC20

OE KINFOR NO:

OE KINFOR NO:

OE KINFOR NO:

适用车型/APPLICATION :  
2007-2011款 奥迪(主) /AUDI Q7 3.0T

总成/ASSEMBLY

扇框/FAN-SHROUD

扇叶/FAN-BLADE

电机/FAN-MOTOR



奥迪 (副) /AUDI Q7 3.0T

2007-2011



 OE 7L0959455F/7L0959455C KINFOR NO: CFAC21

 OE KINFOR NO:

 OE KINFOR NO:

 OE KINFOR NO:

 适用车型/APPLICATION :  
2007-2011款 奥迪(副) /AUDI Q7 3.0T

 总成/ASSEMBLY

 扇框/FAN-SHROUD

 扇叶/FAN-BLADE

 电机/FAN-MOTOR



电子风扇  
Cooling Fan Assembly

总成/ASSEMBLY

扇框/FAN-SHROUD

扇叶/FAN-BLADE

电机/FAN-MOTOR

# 适用丰田系列 FOR TOYOTA SERIES

## 皇冠/CROWN

2005-2010



-  OE 16360-0P060 KINFOR NO: CFTC01
-  OE 16711-0P060 KINFOR NO: CFTC01S
-  OE 16361-0P030/0P050 KINFOR NO: CFTC01F7  
16361-0P020/0P040 CFTC01F5
-  OE 16363-0P010 KINFOR NO: CFTC01ML  
16363-0P020 CFTC01MR
-  **适用车型/APPLICATION :**  
2005-2010款 皇冠/CROWN

## 皇冠/CROWN 2.5L

2015



-  OE 16360-0P310 KINFOR NO: CFTC16
-  OE 16711-0P310 KINFOR NO: CFTC16S
-  OE 16361-0P030/0P050 KINFOR NO: CFTC01F7  
16361-0P020/0P040 CFTC01F5
-  OE 16363-0P350 KINFOR NO: CFTC16MR  
16363-0P340 CFTC16ML
-  **适用车型/APPLICATION :**  
2015款 皇冠/CROWN 2.5L

## 皇冠/CROWN 2.0T

2015





-  OE 16360-0V240 KINFOR NO: CFTC17
-  OE 16711-0V240 KINFOR NO: CFTC17S
-  OE 16361-0V490 KINFOR NO: CFTC17F7  
16361-0V480 CFTC17F5
-  OE 16363-38160 KINFOR NO: CFTC17M
-  **适用车型/APPLICATION :**  
2015款 皇冠/CROWN 2.0T

## 皇冠陆放/AXUH7#陆

2021



-  OE 16360-F0210 KINFOR NO: CFTC37
-  OE 16711-F0210 KINFOR NO: CFTC37S
-  OE KINFOR NO: CFTC37F7
-  OE 16363-31500 KINFOR NO: CFTC37M
-  **适用车型/APPLICATION :**  
2021款 皇冠陆放/AXUH7#陆

 总成/ASSEMBLY

 扇框/FAN-SHROUD

 扇叶/FAN-BLADE

 电机/FAN-MOTOR

## 锐志/MARK-X/REIZ

2006-2008



- OE 16360-0P070 KINFOR NO: CFTC02
- OE 16711-0P070 KINFOR NO: CFTC02S
- OE 16361-0P030/0P050 KINFOR NO: CFTC01F7  
16361-0P020/0P040 CFTC01F5
- OE 16363-0P040 KINFOR NO: CFTC02MR  
16363-0P050 CFTC02ML
- 适用车型/APPLICATION :  
2006-2008款 锐志/MARK-X/REIZ

## 凯美瑞 (冷气) /CAMRY (COND FAN) 2.2L

1992-1996



- OE 88590-33011 KINFOR NO: CFTC57
- OE 88454-33011 KINFOR NO: CFTC57S
- OE 88453-33010 KINFOR NO: CFTC57F5
- OE 88550-33010 KINFOR NO: CFTC57M
- 适用车型/APPLICATION :  
1992-1996款 凯美瑞 (冷气) /CAMRY (COND FAN) 2.2L

## 佳美/CAMRY 2.4L

2004



- OE 16360-28200 KINFOR NO: CFTC19
- OE 16711-28200 KINFOR NO: CFTC19S
- OE 16361-74160 KINFOR NO: CFTC19F7  
16361-22030 CFTC19F5
- OE 16363-02120/23010 KINFOR NO: CFTC03ML  
16363-0H170/28230 CFTC03MR
- 适用车型/APPLICATION :  
2004款 佳美/CAMRY 2.4L

## 凯美瑞/CAMRY 2.4L

2002-2006



- OE 16360-0H030 KINFOR NO: CFTC70
- OE 16711-0H030 KINFOR NO: CFTC70S
- OE 16361-0H010 KINFOR NO: CFTC70F5  
16361-0H020 CFTC70F7
- OE 16363-03100 KINFOR NO: CFTC70ML  
16363-74370 CFTC70MR
- 适用车型/APPLICATION :  
2002-2006款 凯美瑞/CAMRY 2.4L

总成/ASSEMBLY

扇框/FAN-SHROUD

扇叶/FAN-BLADE

电机/FAN-MOTOR

凯美瑞/CAMRY 3.0L

2002-2006







-  OE 16360-0A170 KINFOR NO: CFTC71
-  OE 16711-0A170 KINFOR NO: CFTC71S
-  OE 16361-0A120 KINFOR NO: CFTC71F7  
16361-0A130 CFTC71F9
-  OE 16363-0A100 KINFOR NO: CFTC71M  
16363-0A110
-  适用车型/APPLICATION :  
2002-2006款 凯美瑞/CAMRY 3.0L

凯美瑞/CAMRY

2006-2011







-  OE 16360-0H150 KINFOR NO: CFTC03
-  OE 16711-0H150 KINFOR NO: CFTC03S
-  OE 16361-0H190 KINFOR NO: CFTC03F5  
16361-0H200/0V190 CFTC03F7
-  OE 16363-02120/23010 KINFOR NO: CFTC03ML  
16363-0H170/28230 CFTC03MR
-  适用车型/APPLICATION :  
2006-2011款 凯美瑞/CAMRY

凯美瑞/CAMRY 2.4L

2007-2009



-  OE 16360-0H090 KINFOR NO: CFTC73
-  OE 16711-0H090 KINFOR NO: CFTC73S
-  OE 16361-0H090 KINFOR NO: CFTC73F5  
16361-0H100 CFTC73F7
-  OE 16363-0H010 KINFOR NO: CFTC73ML  
16363-28230 CFTC73MR
-  适用车型/APPLICATION :  
2007-2009款 凯美瑞/CAMRY 2.4L

凯美瑞混动版/CAMRY HYBRID 2.4L

2007-2011



-  OE 16360-28310 KINFOR NO: CFTC74
-  OE 16711-28310 KINFOR NO: CFTC74S
-  OE 16361-28270 KINFOR NO: CFTC74F5  
16361-28280 CFTC74F7
-  OE 16363-28270 KINFOR NO: CFTC74M
-  适用车型/APPLICATION :  
2007-2011款 凯美瑞混动版/CAMRY HYBRID 2.4L

 总成/ASSEMBLY

 扇框/FAN-SHROUD

 扇叶/FAN-BLADE

 电机/FAN-MOTOR

## 凯美瑞/CAMRY 3.5L

2007-2011



- OE 16360-31250 KINFOR NO: CFTC75
- OE 16711-31250 KINFOR NO: CFTC75S
- OE 16361-31120 KINFOR NO: CFTC75F5  
16361-31130 CFTC75F7
- OE 16363-31080 KINFOR NO: CFTC75M  
16363-31090

**适用车型/APPLICATION :**  
2007-2011款 凯美瑞/CAMRY 3.5L  
2006-2012款 雷克萨斯/LEXUS ES350 3.5L

## 凯美瑞/CAMRY 3.5L

2007-2011



- OE 16360-0P200 KINFOR NO: CFTC76
- OE 16711-0P200 KINFOR NO: CFTC76S
- OE 16361-0P250 KINFOR NO: CFTC76F7  
16361-0P260 CFTC76F9
- OE 16363-0A120 KINFOR NO: CFTC76ML  
16363-0P030 CFTC76MR

**适用车型/APPLICATION :**  
2012-2017款 凯美瑞/CAMRY 3.5L

## 凯美瑞/CAMRY

2007-2011



- OE 16360-0V140 KINFOR NO: CFTC04
- OE 16711-0V140 KINFOR NO: CFTC04S
- OE 16361-0H200/0V190 KINFOR NO: CFTC03F7  
16361-0V200 CFTC04F9
- OE 16363-0V240 KINFOR NO: CFTC04MR  
16363-02120/23010 CFTC03ML

**适用车型/APPLICATION :**  
2012-2017款 凯美瑞/CAMRY

## 凯美瑞混动版/CAMRY HYBRID 3.0L

2007-2011



- OE 16360-0V110 KINFOR NO: CFTC77
- OE 16711-0V110 KINFOR NO: CFTC77S
- OE 16361-0V310 KINFOR NO: CFTC77F7  
16361-0V320 CFTC77F9
- OE 16363-0A150 KINFOR NO: CFTC77ML  
16363-0V150 CFTC77MR

**适用车型/APPLICATION :**  
2012-2017款 凯美瑞混动版/CAMRY HYBRID 3.0L

总成/ASSEMBLY

扇框/FAN-SHROUD

扇叶/FAN-BLADE

电机/FAN-MOTOR

凯美瑞混动版/CAMRY HYBRID

2018







-  OE 16360-31510      KINFOR NO: CFTC26
-  OE 16711-31510      KINFOR NO: CFTC26S
-  OE      KINFOR NO: CFTC26F7
-  OE 16363-31510      KINFOR NO: CFTC26M
-  适用车型/APPLICATION :  
2018款 凯美瑞混动版/CAMRY HYBRID

凯美瑞/CAMRY

2018



-  OE 16360-0V340      KINFOR NO: CFTC27
-  OE 16711-0V340      KINFOR NO: CFTC27S
-  OE      KINFOR NO: CFTC26F7
-  OE 16363-31490      KINFOR NO: CFTC27M
-  适用车型/APPLICATION :  
2018款 凯美瑞/CAMRY

RAV4(RAD FAN) 2.2L

1996-2000







-  OE 16360-74540      KINFOR NO: CFTC78
-  OE 16711-74540      KINFOR NO: CFTC78S
-  OE 16361-64030      KINFOR NO: CFTC78F4
-  OE 16363-74170      KINFOR NO: CFTC78M
-  适用车型/APPLICATION :  
1996-2000款 RAV4(RAD FAN) 2.2L

RAV4

2010-2013



-  OE 16360-0H190      KINFOR NO: CFTC05
-  OE 16711-0H190      KINFOR NO: CFTC05S
-  OE 16361-0H290      KINFOR NO: CFTC05F5
- 16361-0H300      CFTC05F7
-  OE 16363-0H220      KINFOR NO: CFTC05ML
- 16363-0H230      CFTC05MR
-  适用车型/APPLICATION :  
2010-2013款 RAV4

 总成/ASSEMBLY

 扇框/FAN-SHROUD

 扇叶/FAN-BLADE

 电机/FAN-MOTOR

## RAV4 2014

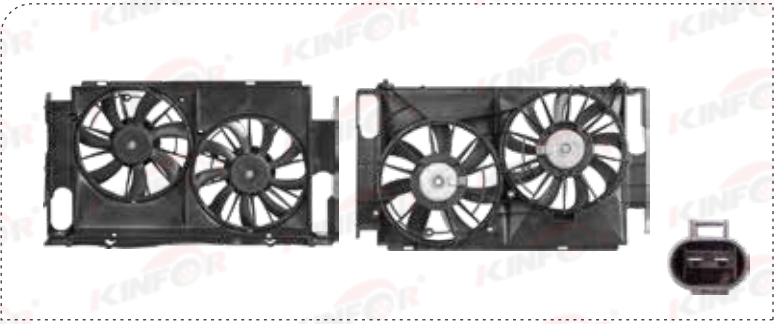

- OE 16360-0V220 KINFOR NO: CFTC06
- OE 16711-0V220 KINFOR NO: CFTC06S
- OE 16361-0V450 KINFOR NO: CFTC06F9  
16361-0H300 CFTC05F7
- OE 16363-0V380 KINFOR NO: CFTC06ML  
16363-0V390 CFTC06MR
- 适用车型/APPLICATION :**  
2014款 RAV4

## 威兰达/ WILDLANDER 2020



- OE 16360-F0090 KINFOR NO: CFTC36
- OE KINFOR NO: CFTC36S
- OE 16361-0H280 KINFOR NO: CFTC26F7
- OE 16363-31500 KINFOR NO: CFTC36M
- 适用车型/APPLICATION :**  
2020款 威兰达/ WILDLANDER

## 卡罗拉(水箱) /COROLLA ( RAD FAN ) 1.6L 1988-1992



- OE 16360-15240 KINFOR NO: CFTC85
- OE 16711-15240 KINFOR NO: CFTC85S
- OE 16361-63020 KINFOR NO: CFTC85F5
- OE 16363-64030 KINFOR NO: CFTC85M
- 适用车型/APPLICATION :**  
1988-1992款 卡罗拉(水箱)  
/COROLLA ( RAD FAN ) 1.6L

## 卡罗拉/COROLLA 1.6L 1.8L 1993-1997



- OE 16360-02050 KINFOR NO: CFTC88
- OE 16711-02050 KINFOR NO: CFTC88S
- OE 16361-02050 KINFOR NO: CFTC88F5
- OE 16363-02040 KINFOR NO: CFTC88M
- 适用车型/APPLICATION :**  
1993-1997款 卡罗拉/COROLLA 1.6L 1.8L

总成/ASSEMBLY    扇框/FAN-SHROUD    扇叶/FAN-BLADE    电机/FAN-MOTOR

电子风扇  
Cooling Fan Assembly



卡罗拉/COROLLA 1.6L 1.8L

1996-1997

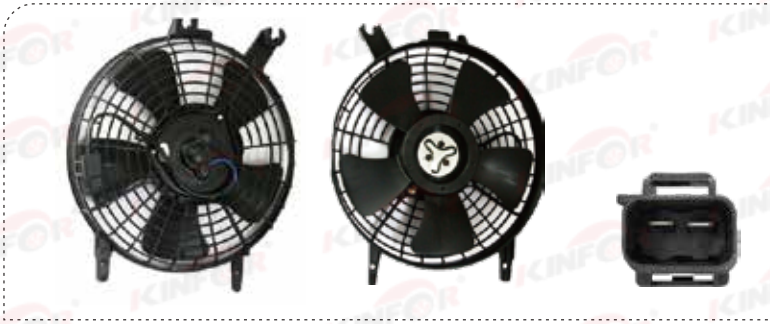





-  OE 88590-12270      KINFOR NO: CFTC89
-  OE 88454-12130      KINFOR NO: CFTC89S
-  OE 88453-10022      KINFOR NO: CFTC89F11
-  OE 88550-12160      KINFOR NO: CFTC89M

 适用车型/APPLICATION :  
1996-1997款 卡罗拉/COROLLA 1.6L 1.8L

花冠/COROLLA

2003-2006





-  OE 16360-21080      KINFOR NO: CFTC08
-  OE 16711-21080      KINFOR NO: CFTC08S
-  OE 16361-21060      KINFOR NO: CFTC08F5
-  OE 16363-28200/0T160      KINFOR NO: CFTC08M

 适用车型/APPLICATION :  
2003-2016款 花冠/COROLLA

卡罗拉/ COROLLA

2003-2007







-  OE 16360-0D072      KINFOR NO: CFTC42
-  OE 16711-0D072      KINFOR NO: CFTC42S
-  OE 16361-0D090      KINFOR NO: CFTC42F5
-  OE 16363-0T040      KINFOR NO: CFTC12M

 适用车型/APPLICATION :  
2003-2007款 卡罗拉/COROLLA

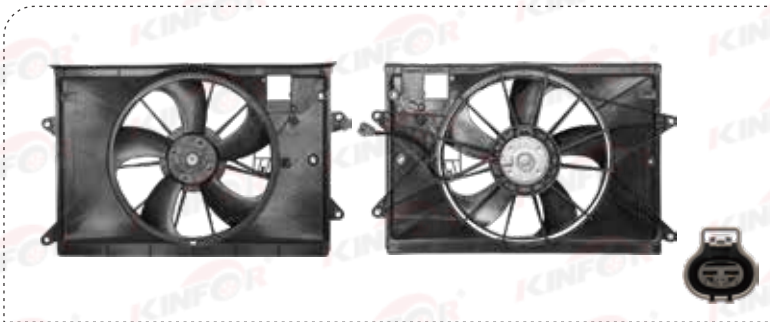
花冠/COROLLA

2007



-  OE 16360-0T020      KINFOR NO: CFTC10
-  OE 16711-0T020      KINFOR NO: CFTC10S
-  OE 16361-0T020      KINFOR NO: CFTC10F5
-  OE 16363-0T030      KINFOR NO: CFTC09M

 适用车型/APPLICATION :  
2007款 花冠/COROLLA

 总成/ASSEMBLY

 扇框/FAN-SHROUD

 扇叶/FAN-BLADE

 电机/FAN-MOTOR

## 卡罗拉/ COROLLA 2007

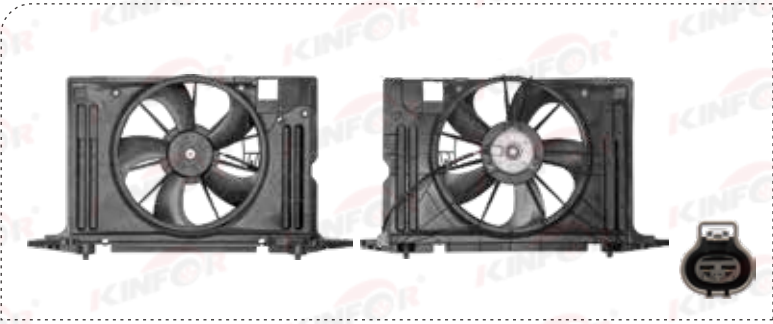

- OE 16360-0T010 KINFOR NO: CFTC09
- OE 16711-0T010 KINFOR NO: CFTC09S
- OE 16361-0T010 KINFOR NO: CFTC09F5
- OE 16363-0T030 KINFOR NO: CFTC09M

**适用车型/APPLICATION :**  
2007款 卡罗拉/COROLLA  
2010-款 逸致/VERSO

## 卡罗拉/ COROLLA 2007-2013



- OE 16360-22150/22160 KINFOR NO: CFTC46
- OE 16711-22150/22160 KINFOR NO: CFTC46S
- OE KINFOR NO: CFTC46F5W
- OE 16363-0T030 KINFOR NO: CFTC09M

**适用车型/APPLICATION :**  
2007-2013款 卡罗拉/COROLLA

## 卡罗拉/COROLLA 1.8L 2009-2013



- OE 88975767 KINFOR NO: CFTC92
- OE KINFOR NO: CFTC92S
- OE KINFOR NO: CFTC92F5
- OE KINFOR NO: CFTC92M

**适用车型/APPLICATION :**  
2009-2013款 卡罗拉/COROLLA 1.8L

## 卡罗拉混合动力/COROLLA HYBRID 2014







- OE 16360-0T140 KINFOR NO: CFTC18
- OE 16711-0T140 KINFOR NO: CFTC18S
- OE 16361-0T130  
16361-0T140 KINFOR NO: CFTC18F7  
CFTC18F9
- OE 16363-28200/0T160  
16363-0T150 KINFOR NO: CFTC08M  
CFTC18MR

**适用车型/APPLICATION :**  
2014款 卡罗拉混合动力/COROLLA HYBRID

卡罗拉/COROLLA 1.2T

2017



-  OE 16360-0Y240      KINFOR NO: CFTC20
-  OE 16711-0Y240      KINFOR NO: CFTC20S
-  OE 16361-0Y270  
16361-0Y260      KINFOR NO: CFTC20F7  
CFTC20F9
-  OE 16363-0Y060  
16363-0Y080      KINFOR NO: CFTC20ML  
CFTC20MR
-  **适用车型/APPLICATION :**  
2017款卡罗拉/COROLLA 1.2T  
2017款 雷凌/LEVIN 1.2T

卡罗拉(美版)/COROLLA 1.8

2014-2018







-  OE 16360-0T040      KINFOR NO: CFTC40
-  OE 16711-0T040      KINFOR NO: CFTC40S
-  OE      KINFOR NO: CFTC30F5
-  OE 16363-0T030      KINFOR NO: CFTC09M
-  **适用车型/APPLICATION :**  
2014-2018款 卡罗拉(美版)/COROLLA 1.8

卡罗拉/COROLLA ALTIS

2014-2018



-  OE 16360-0T101      KINFOR NO: CFTC50
-  OE 16711-0T101      KINFOR NO: CFTC50S
-  OE      KINFOR NO: CFTC50F5W
-  OE 16363-0T140      KINFOR NO: CFTC50M
-  **适用车型/APPLICATION :**  
2014-2018款 卡罗拉/COROLLA ALTIS

卡罗拉/COROLLA 2.0L

2018-2019



-  OE 16360-0T160      KINFOR NO: CFTC93
-  OE 16711-0T160      KINFOR NO: CFTC93S
-  OE 16361-0T170      KINFOR NO: CFTC93F7
-  OE 16363-0T210      KINFOR NO: CFTC93M
-  **适用车型/APPLICATION :**  
2018-2019款 卡罗拉/COROLLA 2.0L

 总成/ASSEMBLY

 扇框/FAN-SHROUD

 扇叶/FAN-BLADE

 电机/FAN-MOTOR

## 卡罗拉/COROLLA 2020

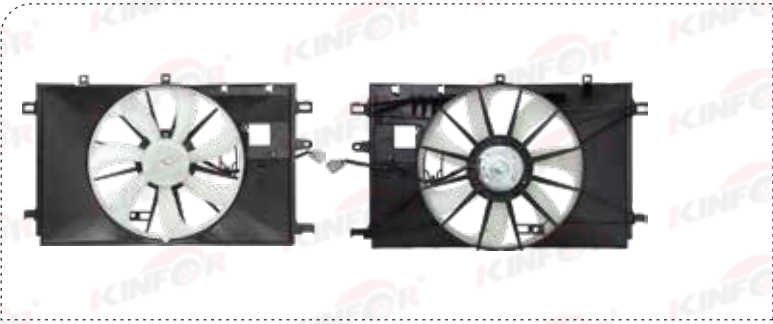

- OE 16360-0T240 KINFOR NO: CFTC47
  - OE 16711-0T240 KINFOR NO: CFTC47S
  - OE 16361-0T320 KINFOR NO: CFTC47F7
  - OE 16363-37130 KINFOR NO: CFTC47M
- 适用车型/APPLICATION :**  
2020款 卡罗拉/COROLLA

## 卡罗拉锐放 燃油版/COROLLA (MXGA10) 2.0L 2022-



- OE 16360-F2160 KINFOR NO: CFTC144
  - OE 16711-F2160 KINFOR NO: CFTC144S
  - OE 16361-F2200 KINFOR NO: CFTC144F7
  - OE 16363-F2020 KINFOR NO: CFTC144M
- 适用车型/APPLICATION :**  
2022-款 卡罗拉锐放 燃油版/COROLLA (MXGA10) 2.0L

## 卡罗拉锐放 混动版/COROLLA HYBRID (MXGH10) 2.0L 2023-



- OE 16360-F2330 KINFOR NO: CFTC145
  - OE KINFOR NO: CFTC145S
  - OE KINFOR NO: CFTC145F7  
CFTC145F9
  - OE KINFOR NO: CFTC145ML  
CFTC145MR
- 适用车型/APPLICATION :**  
2023-款 卡罗拉锐放 混动版  
/COROLLA HYBRID (MXGH10) 2.0L

## 汉兰达/ HIGHLANDER 3.5L 2009-2014



- OE 16360-0P170 KINFOR NO: CFTC21
  - OE 16711-0P170 KINFOR NO: CFTC21S
  - OE 16361-0T010/0P200 KINFOR NO: CFTC09F5  
16361-0P190 CFTC21F7
  - OE 16363-0P200 KINFOR NO: CFTC21ML  
16363-0P210 CFTC21MR
- 适用车型/APPLICATION :**  
2009-2014款 汉兰达/HIGHLANDER 3.5L

汉兰达/HIGHLANDER 3.5L

2008-2010



-  OE 16360-31360 KINFOR NO: CFTC95
-  OE 16711-31360 KINFOR NO: CFTC95S
-  OE 16361-31250  
16361-31260 KINFOR NO: CFTC95F5  
CFTC95F7
-  OE 16363-31270  
16363-31280 KINFOR NO: CFTC95M
-  适用车型/APPLICATION :  
2008-2010款 汉兰达/HIGHLANDER 3.5L

汉兰达/HIGHLANDER 3.5L

2011-2013







-  OE 16360-0P190 KINFOR NO: CFTC96
-  OE 16711-0P190 KINFOR NO: CFTC96S
-  OE 16361-0P180  
16361-0P170 KINFOR NO: CFTC96F5  
CFTC96F7
-  OE 16363-0P240  
16363-0P190 KINFOR NO: CFTC96M
-  适用车型/APPLICATION :  
2011-2013款 汉兰达/HIGHLANDER 3.5L

汉兰达混动版/HIGHLANDER HYBRID 3.3L

2008-2010





-  OE 16360-20190 KINFOR NO: CFTC97
-  OE 16711-20190 KINFOR NO: CFTC97S
-  OE 16361-20250  
16361-20260 KINFOR NO: CFTC97F5  
CFTC97F7
-  OE 16363-20390 KINFOR NO: CFTC97M
-  适用车型/APPLICATION :  
2008-2010款 汉兰达混动版  
/HIGHLANDER HYBRID 3.3L

汉兰达/ HIGHLANDER 2.7L

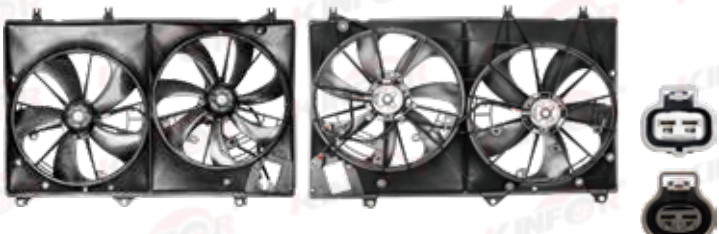
2009-2014



-  OE 16360-0V040 KINFOR NO: CFTC07
-  OE 16711-0V040 KINFOR NO: CFTC07S
-  OE 16361-0V060  
16361-0V050 KINFOR NO: CFTC07F5  
CFTC07F7
-  OE 16363-0V050  
16363-0V060 KINFOR NO: CFTC07ML  
CFTC07MR
-  适用车型/APPLICATION :  
2009-2014款 汉兰达/HIGHLANDER 2.7L

 总成/ASSEMBLY

 扇框/FAN-SHROUD

 扇叶/FAN-BLADE

 电机/FAN-MOTOR

## 汉兰达/HIGHLANDER 2.7L

2009-2013



- OE 16360-36080 KINFOR NO: CFTC99
- OE 16711-36080 KINFOR NO: CFTC99S
- OE 16361-0P210 KINFOR NO: CFTC99F5  
16361-0P220 CFTC99F7
- OE 16363-36030 KINFOR NO: CFTC99M  
16363-36040
- 适用车型/APPLICATION :**  
2009-2013款 汉兰达/HIGHLANDER 2.7L

## 汉兰达/HIGHLANDER 2.7L 3.5L

2014-2018



- OE 16360-0P230 KINFOR NO: CFTC100
- OE 16711-0P230 KINFOR NO: CFTC100S
- OE 16361-0P210 KINFOR NO: CFTC100F7  
16361-0P310 CFTC100F9
- OE 16363-0P230 KINFOR NO: CFTC100M  
16363-0P330
- 适用车型/APPLICATION :**  
2014-2018款 汉兰达/HIGHLANDER 2.7L 3.5L

## 汉兰达/ HIGHLANDER 2.0T

2015



- OE 16360-0V080 KINFOR NO: CFTC14
- OE 16711-0V080 KINFOR NO: CFTC14S
- OE 16361-0V460 KINFOR NO: CFTC14F9  
16361-0V470 CFTC14F7
- OE 16363-0V420 KINFOR NO: CFTC14MR  
16363-0V410 CFTC14ML
- 适用车型/APPLICATION :**  
2015款 汉兰达/HIGHLANDER 2.0T

## 汉兰达/HIGHLANDER

2021

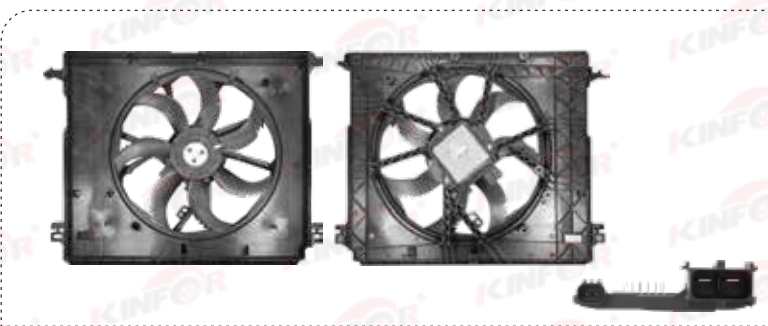

- OE 16360-F0100 KINFOR NO: CFTC38
- OE KINFOR NO: CFTC38S
- OE KINFOR NO: CFTC38F7
- OE 16363-31520 KINFOR NO: CFTC38M
- 适用车型/APPLICATION :**  
2021款 汉兰达/HIGHLANDER

总成/ASSEMBLY

扇框/FAN-SHROUD





扇叶/FAN-BLADE

电机/FAN-MOTOR

威驰(水箱) / VIOS (RAD FAN)

2002-2005





-  OE 16360-02150 KINFOR NO: CFTC11
-  OE 16711-02150 KINFOR NO: CFTC11S
-  OE 16361-02130 KINFOR NO: CFTC11F5
-  OE 16363-02120/23010 KINFOR NO: CFTC03ML

 适用车型/APPLICATION :  
2002-2005款 威驰(水箱) / VIOS (RAD FAN)

威驰(冷气) / VIOS (COND FAN)

2002-2005



-  OE 88454-0D010-ZC KINFOR NO: CFTC29
-  OE 88454-0D010 KINFOR NO: CFTC29S
-  OE 88453-0D010/60010 KINFOR NO: CFTC15F11
-  OE 16363-64080/46060  
88550-0D030/0G010  
88550-60110/12160 KINFOR NO: CFTC15M

 适用车型/APPLICATION :  
2002-2005款 威驰(冷气)/ VIOS (COND FAN)

威驰/ VIOS

2008-2013

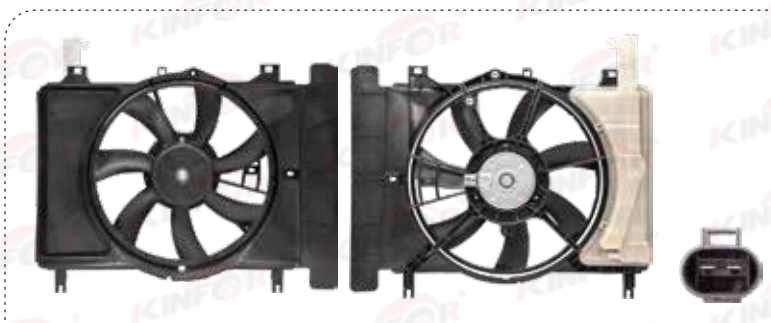





-  OE 16360-0T030 KINFOR NO: CFTC12
-  OE 16711-0T030 KINFOR NO: CFTC12S
-  OE 16361-0T030 KINFOR NO: CFTC12F7
-  OE 16363-0T040 KINFOR NO: CFTC12M

 适用车型/APPLICATION :  
2008-2013款 威驰/ VIOS  
2008-2011款 雅力士/ YARIS

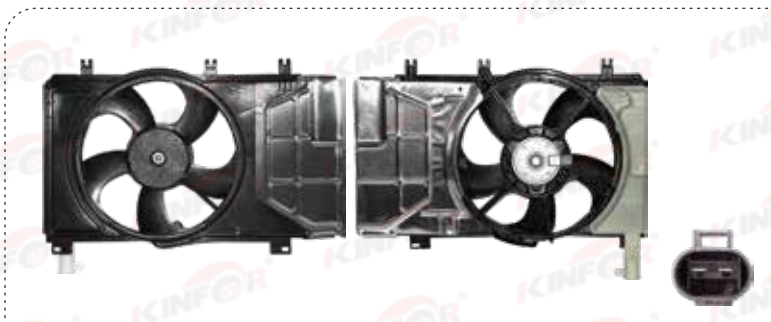
威驰/ VIOS

2014



-  OE 16360-0Y070 KINFOR NO: CFTC13
-  OE 16711-0Y070 KINFOR NO: CFTC13S
-  OE 16361-0Y040 KINFOR NO: CFTC13F5
-  OE 16363-0Y030 KINFOR NO: CFTC13M

 适用车型/APPLICATION :  
2014款 威驰/ VIOS  
2013-2015款 致炫/ YARISL

 总成/ASSEMBLY

 扇框/FAN-SHROUD

 扇叶/FAN-BLADE

 电机/FAN-MOTOR

## 老霸道/PRADO GRJ120

2003-2009



- OE 88590-60060 KINFOR NO: CFTC24
- OE 88454-60030 KINFOR NO: CFTC24S
- OE 88453-0D010/60010 KINFOR NO: CFTC15F-11
- OE 16363-64080/46060 KINFOR NO: CFTC15M  
88550-0D030/0G010  
88550-60110/12160
- 适用车型/APPLICATION :**  
2003-2009款 老霸道/PRADO GRJ120

## 霸道/PRADO GRJ150 4.0L

2010-2013



- OE 88590-60100 KINFOR NO: CFTC22
- OE 88454-0G010 KINFOR NO: CFTC22S
- OE 88453-0G010 KINFOR NO: CFTC22F7
- OE 88550-34010 KINFOR NO: CFTC22M
- 适用车型/APPLICATION :**  
2010-2013款 霸道/PRADO GRJ150 4.0L

## 霸道/PRADO GRJ150 2.7L

2013-2017



- OE 88590-60091 KINFOR NO: CFTC25
- OE 88454-60061 KINFOR NO: CFTC25S
- OE 88453-0D010/60010 KINFOR NO: CFTC15F-11
- OE 16363-64080/46060 KINFOR NO: CFTC15M  
88550-0D030/0G010  
88550-60110/12160
- 适用车型/APPLICATION :**  
2013-2017款 霸道/PRADO GRJ150 2.7L

## 酷路泽/LAND CRUISER

2008-2013



- OE 88590-60080/0G030 KINFOR NO: CFTC23
- OE 88454-60050/0G020 KINFOR NO: CFTC23S
- OE 88453-60020 KINFOR NO: CFTC23F7
- OE 16363-64080/46060 KINFOR NO: CFTC15M  
88550-0D030/0G010  
88550-60110/12160
- 适用车型/APPLICATION :**  
2008-2013款 酷路泽/LAND CRUISER

总成/ASSEMBLY

扇框/FAN-SHROUD

扇叶/FAN-BLADE

电机/FAN-MOTOR



酷路泽/LAND CRUISER ZJ100

2005-2007



-  OE 88590-60030/0G010 KINFOR NO: CFTC15
-  OE 88454-60020 KINFOR NO: CFTC15S
-  OE 88453-0D010/60010 KINFOR NO: CFTC15F11
-  OE 16363-64080/46060  
88550-0D030/0G010  
88550-60110/12160 KINFOR NO: CFTC15M

 **适用车型/APPLICATION :**  
2005-2007款 酷路泽/LAND CRUISER ZJ100

雷凌/ LEVIN 1.2T

2019-



-  OE 16711-0Y270-ZC KINFOR NO: CFTC28
-  OE 16711-0Y270 KINFOR NO: CFTC28S
-  OE 16361-0Y320  
16361-0Y330 KINFOR NO: CFTC28F9  
CFTC28F11
-  OE 16363-47060  
16363-47050 KINFOR NO: CFTC28ML  
CFTC28MR

 **适用车型/APPLICATION :**  
2019-款 雷凌/LEVIN 1.2T

雷凌/LEVIN 1.5T

2018-



-  OE 16360-F2030 KINFOR NO: CFTC39
-  OE 16711-F2030 KINFOR NO: CFTC39S
-  OE 16361-F2050 KINFOR NO: CFTC32F7
-  OE 16363-47060 KINFOR NO: CFTC28ML

 **适用车型/APPLICATION :**  
2018款 雷凌/LEVIN 1.5T

奕泽/IZOA

2018-



-  OE 16360-F2030 KINFOR NO: CFTC32
-  OE 16711-F2030 KINFOR NO: CFTC32S
-  OE 16361-F2050 KINFOR NO: CFTC32F7
-  OE 16363-47060 KINFOR NO: CFTC28ML

 **适用车型/APPLICATION :**  
2018-款 奕泽/IZOA

 总成/ASSEMBLY

 扇框/FAN-SHROUD

 扇叶/FAN-BLADE

 电机/FAN-MOTOR

## 威兰达/WILDLANDER

2020-



- OE 16360-F0090      KINFOR NO: CFTC36
  - OE 16711-F0090      KINFOR NO: CFTC36S
  - OE      KINFOR NO: CFTC26F7
  - OE 16363-31500      KINFOR NO: CFTC36M
- 适用车型/APPLICATION :**  
2020-款 威兰达/WILDLANDER

## 亚洲龙/AVALON-R

2000-2004



- OE 16360-0A160      KINFOR NO: CFTC120
  - OE 16711-0A160      KINFOR NO: CFTC120S
  - OE 16361-0A130      KINFOR NO: CFTC120F9
  - OE 16363-0A050      KINFOR NO: CFTC120M
- 适用车型/APPLICATION :**  
2000-2004款 亚洲龙/AVALON-R

## 亚洲龙/AVALON-L

2000-2004

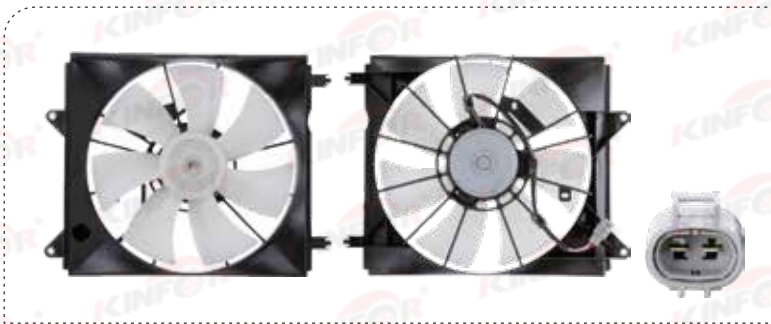

- OE 16360-0A080      KINFOR NO: CFTC127
  - OE 16711-0A080      KINFOR NO: CFTC127S
  - OE 16361-0A120      KINFOR NO: CFTC127F7
  - OE 16363-0A090      KINFOR NO: CFTC127M
- 适用车型/APPLICATION :**  
2000-2004款 亚洲龙/AVALON-L

## 亚洲龙/AVALON

2005-2012



- OE 16360-AD020      KINFOR NO: CFTC122
  - OE 16711-AD020      KINFOR NO: CFTC122S
  - OE 16361-AD010      KINFOR NO: CFTC122F5  
16361 AD020      CFTC122F7
  - OE 16363-0A120      KINFOR NO: CFTC122ML  
16363-0P030      CFTC122MR
- 适用车型/APPLICATION :**  
2005-2012款 亚洲龙/AVALON

总成/ASSEMBLY

扇框/FAN-SHROUD

扇叶/FAN-BLADE

电机/FAN-MOTOR

普锐斯/PRIUS

2004-2009



-  OE 16360-21100      KINFOR NO: CFTC123
-  OE 16711-21100      KINFOR NO: CFTC123S
-  OE 16361-28080      KINFOR NO: CFTC123F5  
CFTC123F7
-  OE 16363-21040      KINFOR NO: CFTC123M
-  适用车型/APPLICATION :  
2004-2009款 普锐斯/PRIUS

塞恩/SCION XA XB

2004-2006



-  OE 16360-21030      KINFOR NO: CFTC125
-  OE 16711-21030      KINFOR NO: CFTC125S
-  OE 16361-23050      KINFOR NO: CFTC125F5
-  OE 16363-23030      KINFOR NO: CFTC125M
-  适用车型/APPLICATION :  
2004-2006款 塞恩/SCION XA XB

特赛尔/TERCEL MT//帕萨奥/PASEO MT

1995-1998



-  OE 16360-11250      KINFOR NO: CFTC124
-  OE 16711-11250      KINFOR NO: CFTC124S
-  OE 16361-11020      KINFOR NO: CFTC124F5
-  OE 16363-11070      KINFOR NO: CFTC124M
-  适用车型/APPLICATION :  
1995-1998款 特赛尔/TERCEL MT  
1996-1998款 帕萨奥/PASEO MT

特赛尔/TERCEL AT//帕萨奥/PASEO AT

1995-1998



-  OE 16360-11260      KINFOR NO: CFTC131
-  OE 16711-11260      KINFOR NO: CFTC131S
-  OE 16361-74070      KINFOR NO: CFTC131F5
-  OE 16363-11080      KINFOR NO: CFTC131M
-  适用车型/APPLICATION :  
1995-1998款 特赛尔/TERCEL AT  
1996-1998款 帕萨奥/PASEO AT

 总成/ASSEMBLY

 扇框/FAN-SHROUD

 扇叶/FAN-BLADE

 电机/FAN-MOTOR

## 特赛尔/TERCEL//帕萨奥/PASEO

1995-1998



- OE 88590-16070 KINFOR NO: CFTC142
- OE 88454-16140 KINFOR NO: CFTC142S
- OE 88453-20080 KINFOR NO: CFTC142F7
- OE 16363-74180 KINFOR NO: CFTC142M

**适用车型/APPLICATION :**  
1995-1998款 特赛尔/TERCEL 1.3L  
1996-1998款 帕萨奥/PASEO

## 塞纳 两驱/SIENNA 3.3L

2003-2005



- OE 16360-0A210 KINFOR NO: CFTC135
- OE 16711-0A210 KINFOR NO: CFTC135S
- OE 16361-0A140 KINFOR NO: CFTC135F5  
16361-0A150 CFTC135F7
- OE 16363-0A120 KINFOR NO: CFTC135M  
16363-0A130

**适用车型/APPLICATION :**  
2003-2005款 塞纳 两驱/SIENNA 3.3L

## 塞纳 四驱/SIENNA 3.3L

2003-2005



- OE 16360-0A220 KINFOR NO: CFTC143
- OE 16711-0A220 KINFOR NO: CFTC143S
- OE 16361-0A150 KINFOR NO: CFTC143F7  
16361-0A200 CFTC143F9
- OE 16363-0A130 KINFOR NO: CFTC143ML  
16363-0A150 CFTC143MR

**适用车型/APPLICATION :**  
2003-2005款 塞纳 四驱/SIENNA 3.3L

## 塞纳/SIENNA 3.5L

2011-2016



- OE 16360-0P150 KINFOR NO: CFTC139
- OE 16711-0P150 KINFOR NO: CFTC139S
- OE 16361-0P150 KINFOR NO: CFTC139F5  
16361-0P160 CFTC139F7
- OE 16363-0P100 KINFOR NO: CFTC139M  
16363-31330

**适用车型/APPLICATION :**  
2011-2016款 塞纳/SIENNA 3.5L

海狮/HIACE

1999-2005



- OE 16360-0H070      KINFOR NO: CFTC136

---

- OE 16711-0H070      KINFOR NO: CFTC136S

---

- OE 16361-0H070  
16361-0H080      KINFOR NO: CFTC136F5

---

- OE 16363-0H050  
16363-0H060      KINFOR NO: CFTC136M

---

- 适用车型/APPLICATION :  
1999-2005款 海狮/HIACE

普瑞维亚ACR50-新款

2006-2019



- OE 16360-28340      KINFOR NO: CFTC146

---

- OE 16711-0H190      KINFOR NO: CFTC05S

---

- OE 16361-0H290  
16361-0H300      KINFOR NO: CFTC05F5  
CFTC05F7

---

- OE 16363-0H220  
16363-38160      KINFOR NO: CFTC05ML  
CFTC17M

---

- 适用车型/APPLICATION :  
2006-2019款 普瑞维亚ACR50-新款

Cooling Fan Assembly

🌀 总成/ASSEMBLY

🌀 扇框/FAN-SHROUD

🌀 扇叶/FAN-BLADE

🌀 电机/FAN-MOTOR



电子风扇  
Cooling Fan Assembly

总成/ASSEMBLY

扇框/FAN-SHROUD

扇叶/FAN-BLADE

电机/FAN-MOTOR

## 适用雷克萨斯系列 FOR LEXUS SERIES

雷克萨斯/LEXUS RX270 2.7L AT MT

2010-2015

	OE 16360-36111	KINFOR NO: CFTC107
	OE 16711-36111	KINFOR NO: CFTC107S
	OE 16361-31320 16361-31310	KINFOR NO: CFTC107F5 CFTC107F7
	OE 16363-31160 16363-70060	KINFOR NO: CFTC107ML CFTC107MR

 **适用车型/APPLICATION :**  
2010-2015款 雷克萨斯/LEXUS RX270 2.7L AT MT

雷克萨斯/LEXUS RX350 3.5L

2006-2008





	OE 16360-31310	KINFOR NO: CFTC113
	OE 16711-31310	KINFOR NO: CFTC113S
	OE 16361-31220 16361-31210	KINFOR NO: CFTC113F5 CFTC113F7
	OE 16363-20270 16363-31160	KINFOR NO: CFTC113ML CFTC113MR

 **适用车型/APPLICATION :**  
2006-2008款 雷克萨斯/LEXUS RX350 3.5L

雷克萨斯/LEXUS RX350 3.5L

2010-2015



	OE 16360-0P150	KINFOR NO: CFTC114
	OE 16711-0P150	KINFOR NO: CFTC114S
	OE 16361-0P170 16361-0P180	KINFOR NO: CFTC114F5 CFTC114F7
	OE 16363-0P180 16363-0P190	KINFOR NO: CFTC114ML CFTC114MR

 **适用车型/APPLICATION :**  
2010-2015款 雷克萨斯/LEXUS RX350 3.5L

雷克萨斯/LEXUS ES200 2.0L AT MT

2018-2019

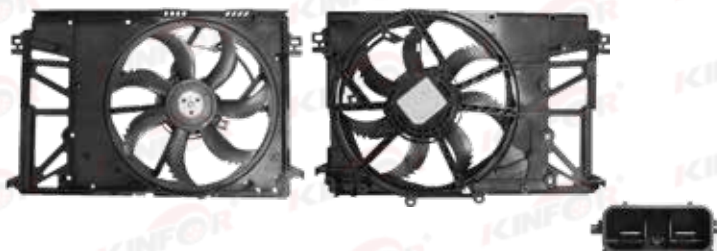

	OE 16360-25010	KINFOR NO: CFTC116
	OE	KINFOR NO: CFTC116S
	OE	KINFOR NO: CFTC116F7
	OE 16363-31490	KINFOR NO: CFTC116M

 **适用车型/APPLICATION :**  
2018-2019款 雷克萨斯/LEXUS ES200 2.0L AT MT  
2018款 雷克萨斯/LEXUS ES260 2.5L AT MT

 总成/ASSEMBLY

 扇框/FAN-SHROUD

 扇叶/FAN-BLADE

 电机/FAN-MOTOR

雷克萨斯/LEXUS ES240 2.4L 5AT MT

2009-2012



- OE 16360-28300 KINFOR NO: CFTC111

---

- OE 16711-28300 KINFOR NO: CFTC111S

---

- OE 16361-28260 KINFOR NO: CFTC111F5  
 16361-28180 CFTC111F7

---

- OE 16363-23010 KINFOR NO: CFTC111ML  
 16363-28230 CFTC111MR

---

- 适用车型/APPLICATION :  
 2009-2012款 雷克萨斯/LEXUS ES240 2.4L 5AT MT

雷克萨斯/LEXUS ES250 2.5L AT MT

2012-2018



- OE 16360-36120 KINFOR NO: CFTC118

---

- OE 16711-36120 KINFOR NO: CFTC118S

---

- OE 16361-36030 KINFOR NO: CFTC118F7  
 16361-36040 CFTC118F9

---

- OE 16363-36060 KINFOR NO: CFTC118ML  
 16363-23010 CFTC118MR

---

- 适用车型/APPLICATION :  
 2012-2018款 雷克萨斯/LEXUS ES250 2.5L AT MT  
 2015-2018款 雷克萨斯/LEXUS ES200 2.0L AT MT

雷克萨斯/LEXUS ES300H 2.5L

2019-2021



- OE 16360-31510 KINFOR NO: CFTC26

---

- OE 16711-31510 KINFOR NO: CFTC26S

---

- OE KINFOR NO: CFTC26F7

---

- OE 16363-31510 KINFOR NO: CFTC26M

---

- 适用车型/APPLICATION :  
 2019-2021款 雷克萨斯/LEXUS ES300H 2.5L

雷克萨斯/LEXUS GX460

2009-



- OE 88590-60091 KINFOR NO: CFTC25

---

- OE 88454-60061 KINFOR NO: CFTC25S

---

- OE 88453-0D010/60010 KINFOR NO: CFTC15F11

---

- OE 16363-64080/46060 KINFOR NO: CFTC15M  
 88550-0D030/0G010  
 88550-60110/12160

---

- 适用车型/APPLICATION :  
 2002-2009款 雷克萨斯/LEXUS GX470

总成/ASSEMBLY

扇框/FAN-SHROUD

扇叶/FAN-BLADE

电机/FAN-MOTOR



雷克萨斯/LEXUS GX470

2002-2009



-  OE 88590-60060 KINFOR NO: CFTC24
-  OE 88454-60030 KINFOR NO: CFTC24S
-  OE 88453-0D010/60010 KINFOR NO: CFTC15F11
-  OE 16363-64080/46060 KINFOR NO: CFTC15M  
88550-0D030/0G010  
88550-60110/12160
-  **适用车型/APPLICATION :**  
2011-2017款 雷克萨斯/LEXUS CT200H

雷克萨斯/LEXUS LX470

1998-2007







-  OE 88590-60030/0G010 KINFOR NO: CFTC15
-  OE 88454-60020 KINFOR NO: CFTC15S
-  OE 88453-0D010/60010 KINFOR NO: CFTC15F11
-  OE 16363-64080/46060 KINFOR NO: CFTC15M  
88550-0D030/0G010  
88550-60110/12160
-  **适用车型/APPLICATION :**  
1998-2007款 雷克萨斯/LEXUS LX470

雷克萨斯/LEXUS LX570

2007-



-  OE 88590-60080/0G030 KINFOR NO: CFTC23
-  OE 88454-60050/0G020 KINFOR NO: CFTC23S
-  OE 88453-60020 KINFOR NO: CFTC23F7
-  OE 16363-64080/46060 KINFOR NO: CFTC15M  
88550-0D030/0G010  
88550-60110/12160
-  **适用车型/APPLICATION :**  
2011-2017款 雷克萨斯/LEXUS CT200H

 总成/ASSEMBLY

 扇框/FAN-SHROUD

 扇叶/FAN-BLADE

 电机/FAN-MOTOR



电子风扇  
Cooling Fan Assembly

总成/ASSEMBLY

扇框/FAN-SHROUD

扇叶/FAN-BLADE

电机/FAN-MOTOR

## 适用传祺系列 FOR TRUMPCHI SERIES

传祺/TRUMPCHI GA3/GA3S 1.6L

2013-2014



	OE 2310005AAF0000	KINFOR NO: CFGC01
	OE	KINFOR NO: CFGC01S
	OE	KINFOR NO: CFGC01F7
	OE	KINFOR NO: CFGC01M
	<b>适用车型/APPLICATION:</b> 2013-2014款传祺GA3/GA3S 1.6L TRUMPCHI GA3/GA3S 1.6L	

传祺/TRUMPCHI GA8

2016

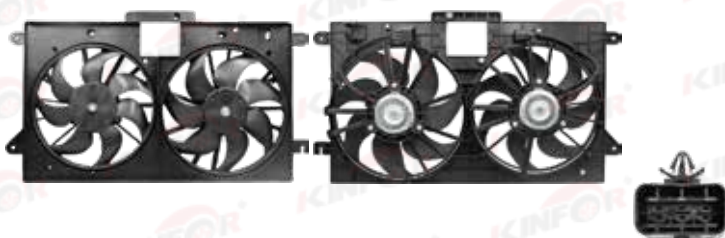

	OE 2310008BAL0000	KINFOR NO: CFGC05
	OE	KINFOR NO: CFGC05S
	OE	KINFOR NO: CFGC05F7D CFGC04F7
	OE	KINFOR NO: CFGC05ML CFGC05MR
	<b>适用车型/APPLICATION:</b> 2016款传祺/TRUMPCHI GA8	

传祺/TRUMPCHI GS8

2016



	OE 2310008CAD0000	KINFOR NO: CFGC06
	OE	KINFOR NO: CFGC06S
	OE	KINFOR NO: CFGC06F7D CFGC04F7
	OE	KINFOR NO: CFGC06ML CFGC06MR
	<b>适用车型/APPLICATION:</b> 2016款传祺/TRUMPCHI GS8	

传祺/TRUMPCHI GS5 2.0L

2012-2014



	OE 2310008BAD98F0	KINFOR NO: CFGC02
	OE 2310006BAD0200	KINFOR NO: CFGC02S
	OE	KINFOR NO: CFGC02F8
	OE	KINFOR NO: CFGC02M
	<b>适用车型/APPLICATION:</b> 2012-2014款传祺/TRUMPCHI GS5 2.0L	

总成/ASSEMBLY

扇框/FAN-SHROUD

扇叶/FAN-BLADE

电机/FAN-MOTOR

传祺/TRUMPCHI GS5 1.8T

2012-2014

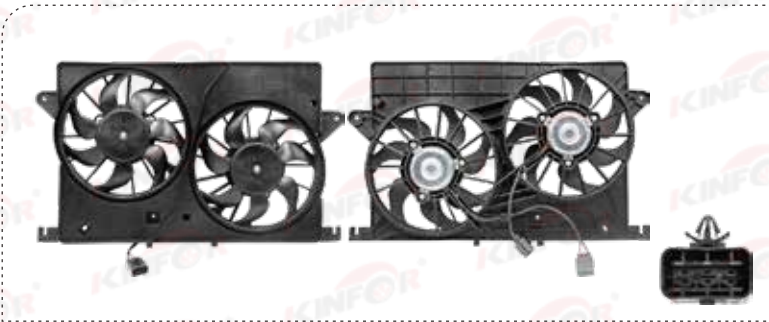

- OE 2310008BAD01F0 KINFOR NO: CFGC03

---

- OE KINFOR NO: CFGC03S

---

- OE KINFOR NO: CFGC03F7

---

- OE KINFOR NO: CFGC03ML  
CFGC03MR

---

- 适用车型/APPLICATION :  
2012-2014款传祺/TRUMPCHI GS5 1.8T

传祺/TRUMPCHI GS4

2015



- OE 2310005ASV0000 KINFOR NO: CFGC04

---

- OE KINFOR NO: CFGC04S

---

- OE KINFOR NO: CFGC04F7  
CFGC04F9

---

- OE KINFOR NO: CFGC04MR  
CFGC04ML

---

- 适用车型/APPLICATION :  
2015款传祺/TRUMPCHI GS4

传祺/TRUMPCHI GA6 1.5T

2019



- OE 2310008ATN0000 KINFOR NO: CFGC08

---

- OE KINFOR NO: CFGC05S

---

- OE KINFOR NO: CFGC05F7  
CFRC09F9

---

- OE KINFOR NO: CFGC05ML  
CFGC05MR

---

- 适用车型/APPLICATION :  
2019款传祺/TRUMPCHI GA6 1.5T

## 适用本田系列 FOR HONDA SERIES

### 三厢飞度(水箱) /CITY (RAD FAN)

2003-2004



-  OE 38615-REJ-W02-ZC KINFOR NO: CFHS03
-  OE 19015-REJ-W01 KINFOR NO: CFHS03S
-  OE 19020-PME-T01 KINFOR NO: CFHS03F5
-  OE 19030-PWA-J51  
19030-REA-Z01 KINFOR NO: CFHS02M
-  **适用车型/APPLICATION :**  
2003-2004款 三厢飞度(水箱) /CITY (RAD FAN)

### 三厢飞度(冷气) /CITY (COND FAN)

2003-2004



-  OE 38615-REJ-W02-ZC KINFOR NO: CFHL03
-  OE 38615-REJ-W02 KINFOR NO: CFHL03S
-  OE 38611-REJ-W01 KINFOR NO: CFHL03F7
-  OE 38616-REJ-W01 KINFOR NO: CFHL03M
-  **适用车型/APPLICATION :**  
2003-2004款 三厢飞度(冷气) /CITY (COND FAN)

### 飞度(水箱) /FIT/JAZZ (RAD FAN)

2005-2006







-  OE 19015-RMN-W01-ZC KINFOR NO: CFHS02
-  OE 19015-RMN-W01 KINFOR NO: CFHS02S
-  OE 19020-PME-T01 KINFOR NO: CFHS03F5
-  OE 19030-PWA-J51  
19030-REA-Z01 KINFOR NO: CFHS02M
-  **适用车型/APPLICATION :**  
2005-2006款 飞度(水箱) /FIT/JAZZ (RAD FAN)

### 飞度(冷气) /FIT/JAZZ (COND FAN)

2005-2006



-  OE 38615-PWA-J01-ZC KINFOR NO: CFHL02
-  OE 38615-PWA-J01 KINFOR NO: CFHL02S
-  OE 38611-PWA-J01 KINFOR NO: CFHL02F7
-  OE 38616-PWA-J01  
38616-P3G-003  
38616-RZP-G01  
38616-RNA-A01  
38616-RZA-A01 KINFOR NO: CFHL02M
-  **适用车型/APPLICATION :**  
2005-2006款 飞度(冷气) /FIT/JAZZ (COND FAN)

 总成/ASSEMBLY

 扇框/FAN-SHROUD

 扇叶/FAN-BLADE

 电机/FAN-MOTOR

## 飞度 (水箱) /FIT/JAZZ (RAD FAN)

2007-2008

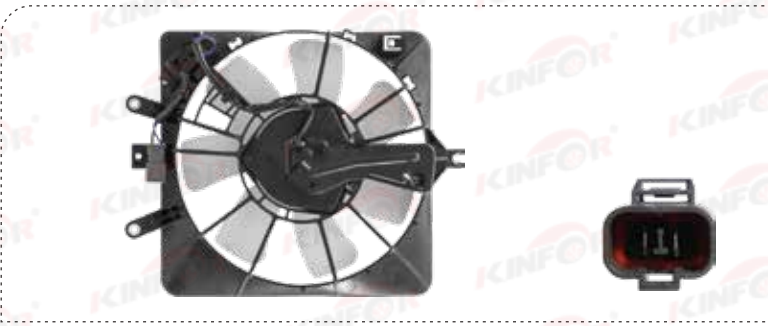

- OE 19015-RME-A51-ZC KINFOR NO: CFHS54
- OE 19015-RME-A51 KINFOR NO: CFHS54S
- OE 38611-RCA-A01 KINFOR NO: CFHS54F4
- OE 19030-RME-A51 KINFOR NO: CFHS54M

适用车型/APPLICATION :  
2007-2008款 飞度 (水箱) /FIT/JAZZ (RAD FAN)

## 飞度 (冷气) /FIT/JAZZ (COND FAN)

2007-2008

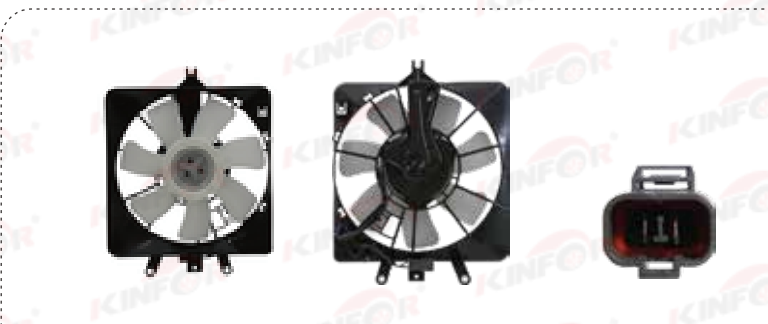

- OE 38615-RME-A01-ZC KINFOR NO: CFHL54
- OE 38615-RME-A01 KINFOR NO: CFHL54S
- OE 38611-PWA-J01 KINFOR NO: CFHL54F7
- OE 38616-PWA-J01 KINFOR NO: CFHL54M

适用车型/APPLICATION :  
2007-2008款 飞度 (冷气) /FIT/JAZZ (COND FAN)

## 飞度(水箱) /FIT/JAZZ (RAD FAN)

2009-2013



- OE 19015-RB0-004-ZC KINFOR NO: CFHS05
- OE 19015-RB0-004 KINFOR NO: CFHS05S
- OE 19020-RB0-004 KINFOR NO: CFHS05F5
- OE 19030-5R3-H01  
19030-RB0-004  
19030-RLF-901  
19030-R1A-A02  
38616-R1A-A01  
38616-5R3-H01  
19030-RR2-H51

适用车型/APPLICATION :  
2009-2013款 飞度(水箱) /FIT/JAZZ (RAD FAN)

## 飞度(冷气) /FIT/JAZZ (COND FAN) MT

2009-2013



- OE 38615-RB0-033-ZC KINFOR NO: CFHL05
- OE 38615-RB0-033 KINFOR NO: CFHL05S
- OE 38611-RC3-H01 KINFOR NO: CFHL05F7
- OE 38616-RB0-003  
19020-RSA-G01

适用车型/APPLICATION :  
2009-2013款 飞度(冷气) /FIT/JAZZ (COND FAN) MT

总成/ASSEMBLY

扇框/FAN-SHROUD





扇叶/FAN-BLADE

电机/FAN-MOTOR

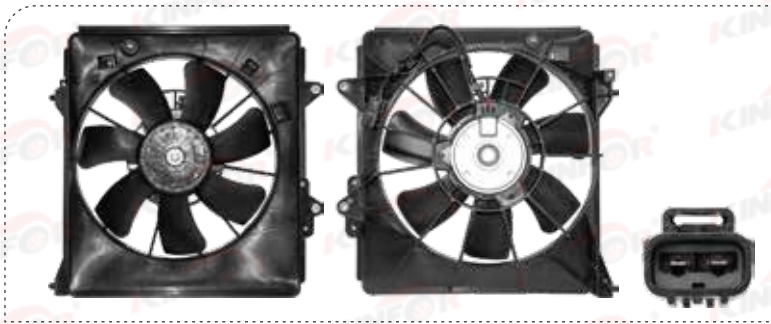
飞度(冷气)/FIT/JAZZ (COND FAN) AT

2009-2013



-  OE 38615-RB1-J51-ZC KINFOR NO: CFHL27
-  OE 38615-RB1-J51 KINFOR NO: CFHL27S
-  OE 38611-RC3-H01 KINFOR NO: CFHL05F7
-  OE 38616-RB0-003 KINFOR NO: CFHL05M

 适用车型/APPLICATION :  
2009-2013款 飞度(冷气)/FIT/JAZZ (COND FAN) AT

飞度(水箱)/FIT/JAZZ (RAD FAN)

2014



-  OE 19015-5R3-H01-ZC KINFOR NO: CFHS06
-  OE 19015-5R3-H01 KINFOR NO: CFHS06S
-  OE 19020-55A-Z01  
19020-5JE-J51 KINFOR NO: CFHS06F5
-  OE 19030-5R3-H01  
19030-RB0-004  
19030-RLF-901  
19030-R1A-A02  
38616-R1A-A01  
38616-5R3-H01  
19030-RR2-H51 KINFOR NO: CFHS06M

 适用车型/APPLICATION :  
2014款 飞度(水箱)/FIT/JAZZ(RAD FAN)

飞度(冷气)/FIT/JAZZ (COND FAN)

2014







-  OE 38615-5R3-H01-ZC KINFOR NO: CFHL06
-  OE 38615-5R3-H01 KINFOR NO: CFHL06S
-  OE 38611-5R3-H01  
38611-R1A-A02 KINFOR NO: CFHL06F7
-  OE 19030-5R3-H01  
19030-RB0-004  
19030-RLF-901  
19030-R1A-A02  
38616-R1A-A01  
38616-5R3-H01  
19030-RR2-H51 KINFOR NO: CFHS06M

 适用车型/APPLICATION :  
2014款 飞度(冷气)/FIT/JAZZ (COND FAN)

飞度(冷气)/FIT/JAZZ (COND FAN) 1.5L

2015-2020



-  OE 38615-5R1-003-ZC KINFOR NO: CFHL55
-  OE 38615-5R1-003 KINFOR NO: CFHL55S
-  OE 38611-5R1-003 KINFOR NO: CFHL55F5
-  OE 38616-5R1-003 KINFOR NO: CFHL55M

 适用车型/APPLICATION :  
2015-2020款 飞度(冷气)  
/FIT/JAZZ (COND FAN) 1.5L

 总成/ASSEMBLY

 扇框/FAN-SHROUD

 扇叶/FAN-BLADE

 电机/FAN-MOTOR

## 锋范 (水箱) /CITY (RAD FAN) 1.8L

2009-2014



- OE 19015-RR2-H51-ZC KINFOR NO: CFHS19
- OE 19015-RR2-H51 KINFOR NO: CFHS19S
- OE 19020-RR2-H51 KINFOR NO: CFHS19F5
- OE 19030-5R3-H01 KINFOR NO: CFHS06M  
19030-RB0-004  
19030-RLF-901  
19030-R1A-A02  
38616-R1A-A01  
38616-5R3-H01  
19030-RR2-H51

**适用车型/APPLICATION :**  
2009-2014款 锋范 (水箱) /CITY (RAD FAN) 1.8L  
2014款 凌派/CRIDER

## 锋范 (冷气) /CITY (COND FAN) 1.8L

2009-2014



- OE 38615-RR2-H01-ZC KINFOR NO: CFHL19
- OE 38615-RR2-H01 KINFOR NO: CFHL19S
- OE 38611-RMX-A51 KINFOR NO: CFHL24F7  
38611-RR2-H01
- OE 38616-R60-U01 KINFOR NO: CFHL15M  
38616-RR2-H01

**适用车型/APPLICATION :**  
2009-2014款 锋范 (冷气) /CITY (COND FAN) 1.8L  
2014款 凌派/CRIDER

## 锋范 (水箱) /CITY (RAD FAN) 1.5L

2019



- OE 19015-55A-Z01-ZC KINFOR NO: CFHS69
- OE 19015-55A-Z01 KINFOR NO: CFHS69S
- OE 19020-55A-Z01 KINFOR NO: CFHS69F5
- OE 19030-55A-Z01 KINFOR NO: CFHS69M

**适用车型/APPLICATION :**  
2019款 锋范 (水箱) /CITY (RAD FAN) 1.5L

## 锋范 (冷气) /CITY (COND FAN) 1.5L

2019



- OE 38615-55A-Z01-ZC KINFOR NO: CFHL69
- OE 38615-55A-Z01 KINFOR NO: CFHL69S
- OE 38611-R1A-A02 KINFOR NO: CFHL69F7
- OE 38616-55A-Z01 KINFOR NO: CFHL69M

**适用车型/APPLICATION :**  
2019款 锋范 (冷气) /CITY (COND FAN) 1.5L

总成/ASSEMBLY

扇框/FAN-SHROUD

扇叶/FAN-BLADE



电机/FAN-MOTOR

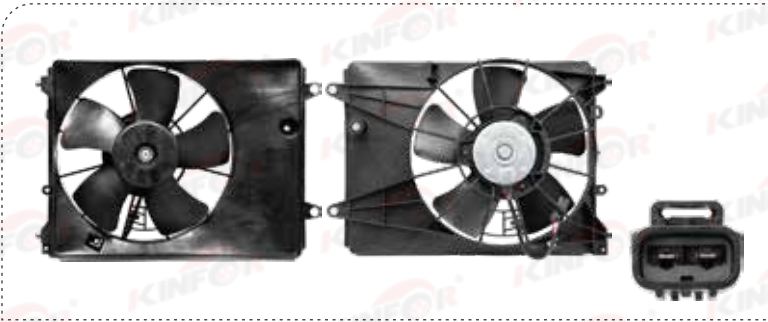

哥瑞(水箱) /GREIZ (RAD FAN)

2015



-  OE 19015-5NE-H01-ZC KINFOR NO: CFHS30
-  OE 19015-5NE-H01 KINFOR NO: CFHS30S
-  OE 19020-5NE-H01 KINFOR NO: CFHS30F5
-  OE 19030-R60-U01 KINFOR NO: CFHS15M  
19030-R3L-G01  
19030-50C-H01  
19030-5G0-A01  
19030-RL9-H01  
19030-5M1-H01

 适用车型/APPLICATION :  
2015款 哥瑞(水箱) /GREIZ (RAD FAN)  
2015款 锋范 /CITY

哥瑞(冷气) /GREIZ (COND FAN)

2015







-  OE 38615-5NE-H01-ZC KINFOR NO: CFHL30
-  OE 38615-5NE-H01 KINFOR NO: CFHL30S
-  OE 38611-REJ-W01 KINFOR NO: CFHL03F7  
38611-R1A-A01
-  OE 38616-5NE-H01 KINFOR NO: CFHL30M  
38616-5PA-A01

 适用车型/APPLICATION :  
2015款 哥瑞(冷气) /GREIZ (COND FAN)  
2015款 锋范/CITY

奥德赛(水箱) /ODYSSEY (RAD FAN)

2005-2008







-  OE 19015-RFE-003-ZC KINFOR NO: CFHS09
-  OE 19015-RFE-003 KINFOR NO: CFHS09S
-  OE 19020-RFG-W01 KINFOR NO: CFHS09F5  
19020-PNA-003
-  OE 19030-RFE-003 KINFOR NO: CFHS09M  
19030-RAA-A01  
19030-PNA-003  
19030-RZA-A01

 适用车型/APPLICATION :  
2005-2008款 奥德赛(水箱) /ODYSSEY (RAD FAN)

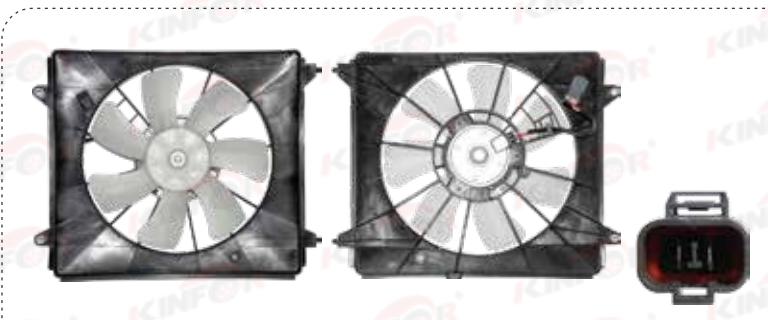
奥德赛(冷气) /ODYSSEY (COND FAN)

2005-2008



-  OE 38615-PFE-003-ZC KINFOR NO: CFHL09
-  OE 38615-PFE-003 KINFOR NO: CFHL09S
-  OE 38611-R40-A02 KINFOR NO: CFHL14F7  
38611-PFE-003  
38611-RFE-003  
38611-R40-A01
-  OE 38616-RFE-003 KINFOR NO: CFHL09M  
19030-R28-H01

 适用车型/APPLICATION :  
2005-2008款 奥德赛(冷气) /ODYSSEY (COND FAN)

 总成/ASSEMBLY

 扇框/FAN-SHROUD

 扇叶/FAN-BLADE

 电机/FAN-MOTOR

## 奥德赛 (水箱) / ODYSSEY (RAD FAN) 3.5L(北美)

2005-2010



- OE 19015-RGL-A01-ZC KINFOR NO: CFHS58
- OE 19015-RGL-A01 KINFOR NO: CFHS58S
- OE 19020-RGL-A01 KINFOR NO: CFHS58F5
- OE 19030-RGL-A01 KINFOR NO: CFHS58M

**适用车型/APPLICATION :**  
2005-2010款 奥德赛 (水箱)  
/ODYSSEY (RAD FAN) 3.5L (北美)

## 奥德赛 (冷气) / ODYSSEY (COND FAN) 3.5L(北美)

2005-2010



- OE 38615-RGL-A01-ZC KINFOR NO: CFHL58
- OE 38615-RGL-A01 KINFOR NO: CFHL58S
- OE 38611-RGL-A01 KINFOR NO: CFHL58F7
- OE 38616-RGL-A01 KINFOR NO: CFHL58M

**适用车型/APPLICATION :**  
2005-2010款 奥德赛 (冷气)  
/ODYSSEY (COND FAN) 3.5L (北美)

## 奥德赛(水箱) / ODYSSEY (RAD FAN)

2009-2014



- OE 19015-RLF-901-ZC KINFOR NO: CFHS08
- OE 19015-RLF-901 KINFOR NO: CFHS08S
- OE 19020-R40-A01 KINFOR NO: CFHS08F5
- OE 19030-5R3-H01  
19030-RB0-004  
19030-RLF-901  
19030-R1A-A02  
38616-R1A-A01  
38616-5R3-H01  
19030-RR2-H51

**适用车型/APPLICATION :**  
2009-2014款 奥德赛(水箱) /ODYSSEY (RAD FAN)

## 奥德赛(冷气) / ODYSSEY (COND FAN)

2009-2014



- OE 38615-RLF-901-ZC KINFOR NO: CFHL08
- OE 38615-RLF-901 KINFOR NO: CFHL08S
- OE 38611-R40-A02  
38611-PFE-003  
38611-RFE-003  
38611-R40-A01
- OE 38616-RLF-901 KINFOR NO: CFHL08M

**适用车型/APPLICATION :**  
2009-2014款 奥德赛(冷气) /ODYSSEY(COND FAN)

总成/ASSEMBLY

扇框/FAN-SHROUD

扇叶/FAN-BLADE

电机/FAN-MOTOR

奥德赛(水箱) / ODYSSEY ( RAD FAN )

2015-







-  OE 19015-5X6-J01-ZC KINFOR NO: CFHS07
-  OE 19015-5X6-J01 KINFOR NO: CFHS07S
-  OE 19020-5A4-H02  
19020-6A0-A01 KINFOR NO: CFHS12F5
-  OE 19030-5X6-J01  
19030-5A4-H01 KINFOR NO: CFHS07M
-  **适用车型/APPLICATION :**

2015款 奥德赛(水箱) / ODYSSEY(RAD FAN)

奥德赛(冷气) / ODYSSEY ( COND FAN )

2015-



-  OE 38615-5X6-J01-ZC KINFOR NO: CFHL07
-  OE 38615-5X6-J01 KINFOR NO: CFHL07S
-  OE 38611-5A4-H02 KINFOR NO: CFHL12F7
-  OE 38616-5X6-J01  
38616-5A4-H01 KINFOR NO: CFHL07M
-  **适用车型/APPLICATION :**

2015款 奥德赛(冷气) / ODYSSEY (COND FAN)

奥德赛(冷气) / ODYSSEY ( COND FAN ) 3.5L

2011-2017







-  OE 38615-RV0-A01-ZC KINFOR NO: CFHL64
-  OE 38615-RV0-A01 KINFOR NO: CFHL64S
-  OE 38611-RV0-A01 KINFOR NO: CFHL64F7
-  OE 38616-RV0-A01 KINFOR NO: CFHL64M
-  **适用车型/APPLICATION :**

2011-2017款 奥德赛(冷气) / ODYSSEY 3.5L (COND FAN)

奥德赛/ODYSSEY//艾力绅 混动版/ ELYSION HYBRID

2019-



-  OE 19015-6W0-H01-ZC KINFOR NO: CFHC42
-  OE 19015-6W0-H01 KINFOR NO: CFHC42S
-  OE 19020-5BA-A01  
19020-5K0-A01 KINFOR NO: CFHC42F7
-  OE 19030-5BA-A01 KINFOR NO: CFHC42M
-  **适用车型/APPLICATION :**

2019-款 奥德赛/ODYSSEY  
2019-款 艾力绅 混动版/ ELYSION HYBRID

 总成/ASSEMBLY

 扇框/FAN-SHROUD

 扇叶/FAN-BLADE

 电机/FAN-MOTOR

**7代雅阁2.4L/7TH GEN ACCORD 2.4L**
**2003-2007**

	OE 19015-RAA-A01-ZC	KINFOR NO: CFHC17
	OE 19015-RAA-A01	KINFOR NO: CFHC17S
	OE 19020-RAH-H01 38611-RAA-A01	KINFOR NO: CFHC17F5 CFHC17F7
	OE 19030-RFE-003 19030-RAA-A01 19030-PNA-003 19030-RZA-A01 138616-RAA-A01	KINFOR NO: CFHS09M CFHC17MR

**适用车型/APPLICATION :**  
 2003-2007款 7代雅阁 /7TH GEN ACCORD 2.4L

**7代雅阁 (水箱) /7TH GEN ACCORD (RAD FAN) 3.0L**
**2003-2007**

	OE 19015-RCA-A01-ZC	KINFOR NO: CFHS18
	OE 19015-RCA-A01	KINFOR NO: CFHS18S
	OE 19020-RCA-A01 19020-R28-H01	KINFOR NO: CFHS18F5
	OE 19030-RCA-A01	KINFOR NO: CFHS18M

**适用车型/APPLICATION :**  
 2003-2007款 7代雅阁 (水箱)  
 /7TH GEN ACCORD 3.0L (RAD FAN)

**7代雅阁 (冷气) /7TH GEN ACCORD (COND FAN) 3.0L**
**2003-2007**

	OE 38615-RCA-A00-ZC	KINFOR NO: CFHL18
	OE 38615-RCA-A00	KINFOR NO: CFHL18S
	OE 38611-RCA-A01	KINFOR NO: CFHL18F4
	OE 38616-P8C-A01	KINFOR NO: CFHL18M

**适用车型/APPLICATION :**  
 2003-2007款 7代雅阁 (冷气)  
 /7TH GEN ACCORD 3.0L (COND FAN)

**8代雅阁 (水箱) /8TH GEN ACCORD (RAD FAN) 2.0L**
**2008-2013**

	OE 19015-R60-U01-ZC	KINFOR NO: CFHS15
	OE 19015-R60-U01	KINFOR NO: CFHS15S
	OE 19020-R60-U01 LF4L15140	KINFOR NO: CFHS15F7
	OE 19030-R60-U01 19030-R3L-G01 19030-50C-H01 19030-5G0-A01 19030-RL9-H01 19030-5M1-H01	KINFOR NO: CFHS15M

**适用车型/APPLICATION :**  
 2008-2013款 8代雅阁 (水箱)  
 /8TH GEN ACCORD 2.0L (RAD FAN)

总成/ASSEMBLY

扇框/FAN-SHROUD

扇叶/FAN-BLADE

电机/FAN-MOTOR

8代雅阁 (冷气) /8TH GEN ACCORD (COND FAN) 2.0L

2008-2013



-  OE 38615-R60-U01-ZC KINFOR NO: CFHL15
-  OE 38615-R60-U01 KINFOR NO: CFHL15S
-  OE 38611-R60-U01 KINFOR NO: CFHL15F5
-  OE 38616-R60-U01  
38616-RR2-H01 KINFOR NO: CFHL15M

 **适用车型/APPLICATION :**  
2008-2013款 8代雅阁 (冷气)  
/8TH GEN ACCORD 2.0L(COND FAN)

8代雅阁 (水箱) /8TH GEN ACCORD (RAD FAN) 2.4L

2008-2013





-  OE 19015-R40-A01-ZC KINFOR NO: CFHS14
-  OE 19015-R40-A01 KINFOR NO: CFHS14S
-  OE 19020-R48-H01  
19020-RWK-J01  
19020-RL8-A01 KINFOR NO: CFHS14F5
-  OE 38616-RBJ-003  
19030-R40-A01 KINFOR NO: CFHS14M

 **适用车型/APPLICATION :**  
2008-2013款 8代雅阁 (水箱)  
/8TH GEN ACCORD 2.4L (RAD FAN)

8代雅阁 (冷气) /8TH GEN ACCORD (COND FAN) 2.4L

2008-2013







-  OE 38615-R40-A01-ZC KINFOR NO: CFHL14
-  OE 38615-R40-A01 KINFOR NO: CFHL14S
-  OE 38611-R40-A02  
38611-PFE-003  
38611-RFE-003  
38611-R40-A01 KINFOR NO: CFHL14F7
-  OE 38616-R40-A01  
38616-5A2-A01  
38616-5G0-A01 KINFOR NO: CFHL14M

 **适用车型/APPLICATION :**  
2008-2013款 8代雅阁 (冷气)  
/8TH GEN ACCORD 2.4L (COND FAN)

8代雅阁 (水箱) /8TH GEN ACCORD (RAD FAN) 3.5L

2008-2013



-  OE 19015-R70-A01-ZC KINFOR NO: CFHS16
-  OE 19015-R70-A01 KINFOR NO: CFHS16S
-  OE 19020-R48-H01  
19020-RWK-J01  
19020-RL8-A01 KINFOR NO: CFHS14F5
-  OE 19030-R60-U01  
19030-R3L-G01  
19030-50C-H01  
19030-5G0-A01  
19030-RL9-H01  
19030-5M1-H01 KINFOR NO: CFHS15M

 **适用车型/APPLICATION :**  
2008-2013款 8代雅阁 (水箱)  
/8TH GEN ACCORD 3.5L (RAD FAN)

 总成/ASSEMBLY

 扇框/FAN-SHROUD

 扇叶/FAN-BLADE

 电机/FAN-MOTOR

**8代雅阁 (冷气) / 8TH GEN ACCORD (COND FAN) 3.5L**
**2008-2013**

- OE 38615-R70-A01-ZC KINFOR NO: CFHL01
- OE 38615-R70-A01 KINFOR NO: CFHL01S
- OE 38611-RL8-A01 KINFOR NO: CFHL13F7
- OE 38616-50C-H01  
38616-R76-H01 KINFOR NO: CFHL01M

**适用车型/APPLICATION :**

 2008-2013款 8代雅阁(冷气)  
 /8TH GEN ACCORD 3.5L (COND FAN)

**9代雅阁 (水箱) / 9TH GEN ACCORD (RAD FAN) 2.0L**
**2014**

- OE 19015-5A2-A01-ZC KINFOR NO: CFHS11
- OE 19015-5A2-A01 KINFOR NO: CFHS11S
- OE 38611-5M1-H01  
19020-RWK-J01  
19020-RJA-J01 KINFOR NO: CFHL21F5
- OE 19030-R60-U01  
19030-R3L-G01  
19030-50C-H01  
19030-5G0-A01  
19030-RL9-H01  
19030-5M1-H01 KINFOR NO: CFHS15M

**适用车型/APPLICATION :**

 2014款 9代雅阁(水箱)  
 /9TH GEN ACCORD 2.0L (RAD FAN)  
 2015款 思铂睿/ SPIRIOR 2.0L

**9代雅阁 (冷气) / 9TH GEN ACCORD (COND FAN) 2.0L**
**2014**

- OE 38615-5A2-A01-ZC KINFOR NO: CFHL11
- OE 38615-5A2-A01 KINFOR NO: CFHL11S
- OE 38611-R40-A02  
38611-PFE-003  
38611-RFE-003  
38611-R40-A01 KINFOR NO: CFHL14F7
- OE 38616-R40-A01  
38616-5A2-A01  
38616-5G0-A01 KINFOR NO: CFHL14M

**适用车型/APPLICATION :**

 2014款 9代雅阁(冷气)  
 /9TH GEN ACCORD 2.0L (COND FAN)  
 2015款 思铂睿/ SPIRIOR 2.0L

**9代雅阁 (水箱) / 9TH GEN ACCORD (RAD FAN) 2.4L**
**2014**

- OE 19015-5A2-A02-ZC KINFOR NO: CFHS12
- OE 19015-5A2-A02 KINFOR NO: CFHS12S
- OE 19020-5A4-H02  
19020-6A0-A01 KINFOR NO: CFHS12F5
- OE 19030-5X6-J01  
19030-5A4-H01 KINFOR NO: CFHS07M

**适用车型/APPLICATION :**

 2014款 9代雅阁 (水箱)  
 /9TH GEN ACCORD 2.4L (RAD FAN)  
 2015款 思铂睿/ SPIRIOR 2.4L

总成/ASSEMBLY

扇框/FAN-SHROUD

扇叶/FAN-BLADE

电机/FAN-MOTOR

9代雅阁 (冷气) /9TH GEN ACCORD (COND FAN) 2.4L

2014



-  OE 38615-5A2-A02-ZC KINFOR NO: CFHL12
-  OE 38615-5A2-A02 KINFOR NO: CFHL12S
-  OE 38611-5A4-H02 KINFOR NO: CFHL12F7
-  OE 38616-5X6-J01  
38616-5A4-H01 KINFOR NO: CFHL07M

 适用车型/APPLICATION :

2014款 9代雅阁(冷气)  
/9TH GEN ACCORD 2.4L (COND FAN)  
2015款 思铂睿/ SPIRIOR 2.4L

9代雅阁 (水箱) /9TH GEN ACCORD (RAD FAN) 3.0L

2014



-  OE 19015-5A2-A01-ZC KINFOR NO: CFHS11
-  OE 19015-5A2-A01 KINFOR NO: CFHS11S
-  OE 38611-5M1-H01  
19020-RWK-J01  
19020-RJA-J01 KINFOR NO: CFHL21F5
-  OE 19030-R60-U01  
19030-R3L-G01  
19030-50C-H01  
19030-5G0-A01  
19030-RL9-H01  
19030-5M1-H01 KINFOR NO: CFHS15M

 适用车型/APPLICATION :

2014款 9代雅阁 (水箱)  
/ 9TH GEN ACCORD 3.0L(RAD FAN)

9代雅阁 (冷气) /9TH GEN ACCORD (COND FAN) 3.0L

2014



-  OE 38615-5G0-A01-ZC KINFOR NO: CFHL13
-  OE 38615-5G0-A01 KINFOR NO: CFHL13S
-  OE 38611-RL8-A01 KINFOR NO: CFHL13F7
-  OE 38616-R40-A01  
38616-5A2-A01  
38616-5G0-A01 KINFOR NO: CFHL14M

 适用车型/APPLICATION :

2014款 9代雅阁 (冷气)  
/9TH GEN ACCORD 3.0L(COND FAN)

10代雅阁 (水箱) /10TH GEN ACCORD (RAD FAN) 1.5T

2018



-  OE 19015-6A0-A01-ZC KINFOR NO: CFHS34
-  OE 19015-6A0-A01 KINFOR NO: CFHS34S
-  OE 19020-5A4-H02  
19020-6A0-A01 KINFOR NO: CFHS12F5
-  OE 19030-6A0-A01  
19030-6P7-H01 KINFOR NO: CFHS34M

 适用车型/APPLICATION :

2018-款 10代雅阁 (水箱)  
/10TH GEN ACCORD 1.5T (RAD FAN)

 总成/ASSEMBLY

 扇框/FAN-SHROUD

 扇叶/FAN-BLADE

 电机/FAN-MOTOR

## 10代雅阁 (冷气) /10TH GEN ACCORD ( COND FAN ) 1.5T 2018



- OE 38615-6A0-A01-ZC KINFOR NO: CFHL34
- OE 38615-6A0-A01 KINFOR NO: CFHL34S
- OE 38611-5PF-N11 KINFOR NO: CFHL34F7
- OE 38616-6A0-A01  
38616-6P7-H01 KINFOR NO: CFHL34M
- 适用车型/APPLICATION :**  
2018款 10代雅阁 (冷气)  
/10TH GEN ACCORD 1.5T (COND FAN)

## 10代雅阁 (混动) /10TH GEN ACCORD HYBRID 2.0L 2018



- OE 19015-6C1-A01-ZC KINFOR NO: CFHC35
- OE 19015-6C1-A01 KINFOR NO: CFHC35S
- OE 19020-6C1-A01 KINFOR NO: CFHC35F7
- OE 19030-5BA-A01 KINFOR NO: CFHC35M
- 适用车型/APPLICATION :**  
2018款 10代雅阁 (混动)  
/10TH GEN ACCORD HYBRID 2.0L

## 思铂睿 (水箱) /SPIRIOR ( RAD FAN ) 2.4L 2010-2014



- OE 19015-RL9-H01-ZC KINFOR NO: CFHS28
- OE 19015-RL9-H01 KINFOR NO: CFHS28S
- OE 19020-RSA-G01  
19020-RCJ-A01 KINFOR NO: CFHS26F5
- OE 19030-R60-U01  
19030-R3L-G01  
19030-50C-H01  
19030-5G0-A01  
19030-RL9-H01  
19030-5M1-H01 KINFOR NO: CFHS15M
- 适用车型/APPLICATION :**  
2010-2014款 思铂睿 (水箱) /SPIRIOR 2.4L(RAD FAN)

## 思铂睿 (冷气) /SPIRIOR ( COND FAN ) 2.4L 2010-2014







- OE 38615-R40-A01-ZC KINFOR NO: CFHL14
- OE 38615-R40-A01 KINFOR NO: CFHL14S
- OE 38611-R40-A02  
38611-PFE-003  
38611-RFE-003  
38611-R40-A01 KINFOR NO: CFHL14F7
- OE 38616-R40-A01  
38616-5A2-A01  
38616-5G0-A01 KINFOR NO: CFHL14M
- 适用车型/APPLICATION :**  
2010-2014款 思铂睿 (冷气) /SPIRIOR 2.4L (COND FAN)



思铂睿/SPIRIOR //9代雅阁 混动/9TH GEN ACCORD HYBRID

2017

-  OE 19015-5K0-A01-ZC KINFOR NO: CFHC40
-  OE 19015-5K0-A01 KINFOR NO: CFHC40S
-  OE 19020-5BA-A01  
19020-5K0-A01 KINFOR NO: CFHC42F7
-  OE 19030-5K0-A02 KINFOR NO: CFHC40M

 适用车型/APPLICATION :

2017-款 思铂睿/SPIRIOR  
2017-款 9代雅阁 混动版/9TH GEN ACCORD HYBRID

歌诗图 (水箱) /CROSSTOUR (RAD FAN)

2014-2016



-  OE 19015-50C-H01-ZC KINFOR NO: CFHS01
-  OE 19015-50C-H01 KINFOR NO: CFHS01S
-  OE 19020-R48-H01  
19020-RWK-J01  
19020-RL8-A01 KINFOR NO: CFHS14F5
-  OE 19030-R60-U01  
19030-R3L-G01  
19030-50C-H01  
19030-5G0-A01  
19030-RL9-H01  
19030-5M1-H01 KINFOR NO: CFHS15M





 适用车型/APPLICATION :

2014-2016款 歌诗图 (水箱) /CROSSTOUR (RAD FAN)

歌诗图 (冷气) /CROSSTOUR (COND FAN)

2014-2016



-  OE 38615-R70-A01-ZC KINFOR NO: CFHL01
-  OE 38615-R70-A01 KINFOR NO: CFHL01S
-  OE 38611-RL8-A01 KINFOR NO: CFHL13F7
-  OE 38616-50C-H01  
38616-R76-H01 KINFOR NO: CFHL01M





 适用车型/APPLICATION :

2014-2016款 歌诗图 (冷气) /CROSSTOUR (COND FAN)

CR-V (水箱) /CR-V (RAD FAN)

2002-2006



-  OE 19015-PNB-003-ZC KINFOR NO: CFHS22
-  OE 19015-PNB-003 KINFOR NO: CFHS22S
-  OE 19020-RFG-W01  
19020-PNA-003 KINFOR NO: CFHS09F5
-  OE 19030-RFE-003  
19030-RAA-A01  
19030-PNA-003  
19030-RZA-A01 KINFOR NO: CFHS09M

 适用车型/APPLICATION :

2002-2006款 CR-V (水箱) /CR-V (RAD FAN)

 总成/ASSEMBLY

 扇框/FAN-SHROUD

 扇叶/FAN-BLADE

 电机/FAN-MOTOR

## CR-V (冷气) / CR-V (COND FAN)

2002-2006



	OE 38615-PNL-G02-ZC	KINFOR NO: CFHL22
	OE 38615-PNL-G02	KINFOR NO: CFHL22S
	OE 38611-PWA-J01	KINFOR NO: CFHL02F7
	OE 38616-PWA-J01 38616-P3G-003 38616-RZP-G01 38616-RNA-A01 38616-RZA-A01	KINFOR NO: CFHL02M

适用车型/APPLICATION :  
2002-2006款 CR-V (冷气) / CR-V (COND FAN)

## CR-V (水箱) / CR-V (RAD FAN)

2007-2011



	OE 19015-RZA-A01-ZC	KINFOR NO: CFHS23
	OE 19015-RZA-A01	KINFOR NO: CFHS23S
	OE 19020-RFG-W01 19020-PNA-003	KINFOR NO: CFHS09F5
	OE 19030-RFE-003 19030-RAA-A01 19030-PNA-003 19030-RZA-A01	KINFOR NO: CFHS09M

适用车型/APPLICATION :  
2007-2011款 CR-V (水箱) / CR-V (RAD FAN)

## CR-V (冷气) / CR-V (COND FAN) 2.0L

2007-2011

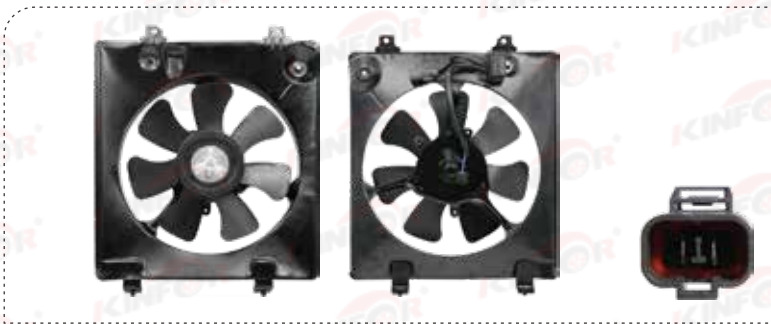

	OE 38615-RZP-G01-ZC	KINFOR NO: CFHL23
	OE 38615-RZP-G01	KINFOR NO: CFHL23S
	OE 38611-PWA-J01	KINFOR NO: CFHL02F7
	OE 38616-PWA-J01 38616-P3G-003 38616-RZP-G01 38616-RNA-A01 38616-RZA-A01	KINFOR NO: CFHL02M

适用车型/APPLICATION :  
2007-2011款 CR-V (冷气) / CR-V (COND FAN) 2.0L

## CR-V (冷气) / CR-V (COND FAN) 2.4L

2007-2011



	OE 38615-RZA-A01-ZC	KINFOR NO: CFHL37
	OE 38615-RZA-A01	KINFOR NO: CFHL37S
	OE 38611-PWA-J01	KINFOR NO: CFHL02F7
	OE 38616-PWA-J01 38616-P3G-003 38616-RZP-G01 38616-RNA-A01 38616-RZA-A01	KINFOR NO: CFHL02M

适用车型/APPLICATION :  
2007-2011款 CR-V (冷气) / CR-V (COND FAN) 2.4L

总成/ASSEMBLY

扇框/FAN-SHROUD





扇叶/FAN-BLADE

电机/FAN-MOTOR

CR-V (水箱) /CR-V (RAD FAN)

2012-2014







-  OE 19015-R5A-A01-ZC KINFOR NO: CFHS24
-  OE 19015-R5A-A01 KINFOR NO: CFHS24S
-  OE 19020-RSA-G01  
19020-RCJ-A01 KINFOR NO: CFHS26F5
-  OE 38616-RB0-003  
19020-RSA-G01 KINFOR NO: CFHL05M
-  **适用车型/APPLICATION :**  
2012-2014款 CR-V (水箱) /CR-V (RAD FAN)

CR-V (冷气) /CR-V (COND FAN) 2.0L

2012-2014







-  OE 38615-R6A-J01-ZC KINFOR NO: CFHL38
-  OE 38615-R6A-J01 KINFOR NO: CFHL38S
-  OE 38611-RMX-A51  
38611-RR2-H01 KINFOR NO: CFHL24F7
-  OE 38616-R5A-A01  
38616-5LA-A01 KINFOR NO: CFHL24M
-  **适用车型/APPLICATION :**  
2012-2014款 CR-V (冷气) /CR-V (COND FAN) 2.0L

CR-V (冷气) /CR-V (COND FAN) 2.4L

2012-2014







-  OE 38615-R5A-A01-ZC KINFOR NO: CFHL24
-  OE 38615-R5A-A01 KINFOR NO: CFHL24S
-  OE 38611-RMX-A51  
38611-RR2-H01 KINFOR NO: CFHL24F7
-  OE 38616-R5A-A01  
38616-5LA-A01 KINFOR NO: CFHL24M
-  **适用车型/APPLICATION :**  
2012-2014款 CR-V (冷气) /CR-V (COND FAN) 2.4L

CR-V(水箱) /CR-V (RAD FAN)

2015-2016



-  OE 19015-5LA-A01-ZC KINFOR NO: CFHS32
-  OE 19015-5LA-A01 KINFOR NO: CFHS32S
-  OE 19020-RSA-G01  
19020-RCJ-A01 KINFOR NO: CFHS26F5
-  OE 38616-RB0-003  
19020-RSA-G01 KINFOR NO: CFHL05M
-  **适用车型/APPLICATION :**  
2015-2016款 CR-V(水箱) /CR-V (RAD FAN)

 总成/ASSEMBLY

 扇框/FAN-SHROUD

 扇叶/FAN-BLADE

 电机/FAN-MOTOR

## CR-V(冷气) / CR-V (COND FAN)

2015-2016



- OE 38615-5LA-A01-ZC KINFOR NO: CFHL32
- OE 38615-5LA-A01 KINFOR NO: CFHL32S
- OE 38611-RMX-A51  
38611-RR2-H01 KINFOR NO: CFHL24F7
- OE 38616-R5A-A01  
38616-5LA-A01 KINFOR NO: CFHL24M
- 适用车型/APPLICATION :**  
2015-2016款 CR-V(冷气) / CR-V (COND FAN)

## CR-V(水箱) / CR-V (RAD FAN)

2017



- OE 19015-5PA-A01-ZC KINFOR NO: CFHS33
- OE 19015-5PA-A01 KINFOR NO: CFHS33S
- OE 16361-0T020  
19020-5PA-A01 KINFOR NO: CFTC10F5
- OE 38616-RBJ-003  
19030-R40-A01 KINFOR NO: CFHS14M
- 适用车型/APPLICATION :**  
2017款 CR-V(水箱) / CR-V (RAD FAN)

## CR-V(冷气) / CR-V (COND FAN)

2017



- OE 38615-5PA-A01-ZC KINFOR NO: CFHL33
- OE 38615-5PA-A01 KINFOR NO: CFHL33S
- OE 38611-5PA-A01 KINFOR NO: CFHL33F7
- OE 38616-5NE-H01  
38616-5PA-A01 KINFOR NO: CFHL30M
- 适用车型/APPLICATION :**  
2017款 CR-V (冷气) / CR-V (COND FAN)

## CR-V 混动版/CR-V HYBRID

2017

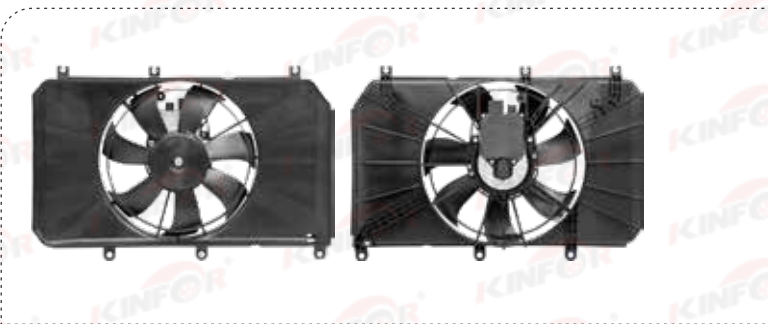

- OE 19015-5TZ-H01-ZC KINFOR NO: CFHC39
- OE 19015-5TZ-H01 KINFOR NO: CFHC39S
- OE 19020-5TZ-H01 KINFOR NO: CFHC39F7
- OE 19030-5MN-004 KINFOR NO: CFHC39M
- 适用车型/APPLICATION :**  
2017款 CR-V 混动版/CR-V HYBRID  
2019款 皓影 混动版 / BREEZE HYBRID

总成/ASSEMBLY

扇框/FAN-SHROUD





扇叶/FAN-BLADE

电机/FAN-MOTOR

CR-Z (水箱) / CR-Z (RAD FAN) 1.5L

2011-2016







-  OE 19015-RBJ-004-ZC KINFOR NO: CFHS74
-  OE 19015-RBJ-004 KINFOR NO: CFHS74S
-  OE 19020-RB0-004 KINFOR NO: CFHS74F5
-  OE 19030-RB0-004 KINFOR NO: CFHS74M

 适用车型/APPLICATION :  
2011-2016款 CR-Z (水箱) / CR-Z (RAD FAN) 1.5L

CR-Z (冷气) / CR-Z (COND FAN) 1.5L

2011-2016







-  OE 38615-RBJ-003-ZC KINFOR NO: CFHL74
-  OE 38615-RBJ-003 KINFOR NO: CFHL74S
-  OE 38611-RBB-003 KINFOR NO: CFHL74F7
-  OE 38616-RBJ-003 KINFOR NO: CFHL74M

 适用车型/APPLICATION :  
2011-2016款 CR-Z (冷气) / CR-Z (COND FAN) 1.5L

思域(水箱) / CIVIC (RAD FAN)

2006-2011







-  OE 19015-RNA-A01-ZC KINFOR NO: CFHS26
-  OE 19015-RNA-A01 KINFOR NO: CFHS26S
-  OE 19020-RSA-G01  
19020-RCJ-A01 KINFOR NO: CFHS26F5
-  OE 19030-RNA-A51 KINFOR NO: CFHS26M

 适用车型/APPLICATION :  
2006-2011款 思域(水箱) / CIVIC (RAD FAN)

思域(冷气) / CIVIC (COND FAN)

2006-2011



-  OE 38615-RNA-A01-ZC KINFOR NO: CFHL26
-  OE 38615-RNA-A01 KINFOR NO: CFHL26S
-  OE 38611-PWA-J01 KINFOR NO: CFHL02F7
-  OE 38616-PWA-J01  
38616-P3G-003  
38616-RZP-G01  
38616-RNA-A01  
38616-RZA-A01 KINFOR NO: CFHL02M

 适用车型/APPLICATION :  
2006-2011款 思域(冷气) / CIVIC (COND FAN)

 总成/ASSEMBLY

 扇框/FAN-SHROUD

 扇叶/FAN-BLADE

 电机/FAN-MOTOR

## 思域 (水箱) /CIVIC (RAD FAN)

2012-2014



- OE 19015-R1A-A02-ZC KINFOR NO: CFHS25
- OE 19015-R1A-A02 KINFOR NO: CFHS25S
- OE 19020-R1A-A01 KINFOR NO: CFHS25F5
- OE 19030-5R3-H01 KINFOR NO: CFHS06M  
19030-RB0-004  
19030-RLF-901  
19030-R1A-A02  
38616-R1A-A01  
38616-5R3-H01  
19030-RR2-H51

**适用车型/APPLICATION :**  
2012-2014款 思域 (水箱) /CIVIC (RAD FAN)

## 思域 (冷气) /CIVIC (COND FAN)

2012-2014



- OE 38615-R1A-A02-ZC KINFOR NO: CFHL25
- OE 38615-R1A-A02 KINFOR NO: CFHL25S
- OE 38611-5R3-H01 KINFOR NO: CFHL06F7  
38611-R1A-A02
- OE 19030-5R3-H01 KINFOR NO: CFHS06M  
19030-RB0-004  
19030-RLF-901  
19030-R1A-A02  
38616-R1A-A01  
38616-5R3-H01  
19030-RR2-H51

**适用车型/APPLICATION :**  
2012-2014款 思域 (冷气) /CIVIC (COND FAN)

## 思域 (冷气) /CIVIC (COND FAN) 1.8L (北美)

2012-2015



- OE 38615-R1A-A01-ZC KINFOR NO: CFHL77
- OE 38615-R1A-A01 KINFOR NO: CFHL77S
- OE 38611-R1A-A01 KINFOR NO: CFHL77F7
- OE 38616-R1A-A01 KINFOR NO: CFHL77M

**适用车型/APPLICATION :**  
2012-2015款 思域 (冷气) /CIVIC (COND FAN) 1.8L

## 思域 /CIVIC 1.5T

2016



- OE 19015-5AG-H01-ZC KINFOR NO: CFHC29
- OE 19015-5AG-H01 KINFOR NO: CFHC29S
- OE 19020-5AA-A01 KINFOR NO: CFHC29F7
- OE 19030-5AA-A01 KINFOR NO: CFHC29M

**适用车型/APPLICATION :**  
2016款 思域/CIVIC 1.5T

总成/ASSEMBLY

扇框/FAN-SHROUD

扇叶/FAN-BLADE

电机/FAN-MOTOR

思域 (水箱) / CIVIC (RAD FAN) 1.5T

2022-2023



-  OE 19015-64A-A01-ZC KINFOR NO: CFHS41
  -  OE 19015-64A-A01 KINFOR NO: CFHS41S
  -  OE 19020-64A-A01 KINFOR NO: CFHS41F5
  -  OE 19030-64A-A01 KINFOR NO: CFHS41M
-  **适用车型/APPLICATION :**  
2022-2023款 思域(水箱)/CIVIC (RAD FAN) 1.5T

思域 (冷气) / CIVIC (COND FAN) 1.5T

2022-2023







-  OE 38615-64A-A01-ZC KINFOR NO: CFHL41
  -  OE 38615-64A-A01 KINFOR NO: CFHL41S
  -  OE 38611-64A-A01 KINFOR NO: CFHL41F5
  -  OE 38616-64A-A01 KINFOR NO: CFHL41M
-  **适用车型/APPLICATION :**  
2022-2023款 思域(冷气)/CIVIC (COND FAN) 1.5T

缤智 (水箱) / VEZEL (RAD FAN)

2015



-  OE 19015-51B-H01-ZC KINFOR NO: CFHS20
  -  OE 19015-51B-H01 KINFOR NO: CFHS20S
  -  OE 19020-RSA-G01  
19020-RCJ-A01 KINFOR NO: CFHS26F5
  -  OE 38616-5R1-003 KINFOR NO: CFHS20M
-  **适用车型/APPLICATION :**  
2015款 缤智(水箱) / VEZEL (RAD FAN)  
2015款 X-RV

缤智 (冷气) / VEZEL (COND FAN)

2015

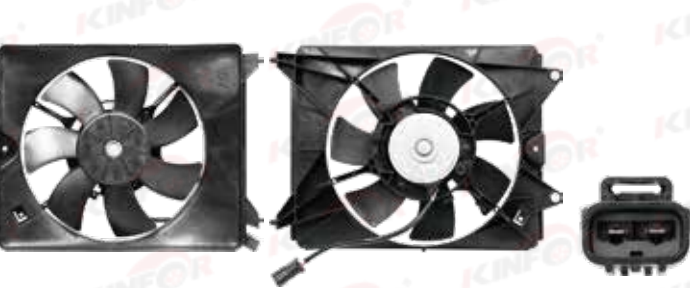

-  OE 38615-50W-H01-ZC KINFOR NO: CFHL20
  -  OE 38615-50W-H01 KINFOR NO: CFHL20S
  -  OE 38611-R1A-A01 KINFOR NO: CFHC17F7
  -  OE 38616-51B-H01 KINFOR NO: CFHL20M
-  **适用车型/APPLICATION :**  
2015款 缤智(冷气) / VEZEL (COND FAN)  
2015款 X-RV

 总成/ASSEMBLY

 扇框/FAN-SHROUD

 扇叶/FAN-BLADE

 电机/FAN-MOTOR

## 杰德 (水箱) /JADE (RAD FAN)

2014



	OE 19015-5M1-H01-ZC	KINFOR NO: CFHS21
	OE 19015-5M1-H01	KINFOR NO: CFHS21S
	OE 19020-R60-U01 LF4L15140	KINFOR NO: CFHS15F7
	OE 19030-R60-U01 19030-R3L-G01 19030-50C-H01 19030-5G0-A01 19030-RL9-H01 19030-5M1-H01	KINFOR NO: CFHS15M

适用车型/APPLICATION :  
2014款 杰德 (水箱) /JADE (RAD FAN)

## 杰德 (冷气) /JADE (COND FAN)

2014



	OE 38615-5M1-H01-ZC	KINFOR NO: CFHL21
	OE 38615-5M1-H01	KINFOR NO: CFHL21S
	OE 38611-5M1-H01 19020-RWK-J01 19020-RJA-J01	KINFOR NO: CFHL21F5
	OE 38616-5M1-H01	KINFOR NO: CFHL21M

适用车型/APPLICATION :  
2014款 杰德 (冷气) /JADE (COND FAN)

## 冠道 (水箱) /AVANCIER (RAD FAN)

2016



	OE 19015-5MS-H01-ZC	KINFOR NO: CFHS31
	OE 19015-5MS-H01	KINFOR NO: CFHS31S
	OE 38611-5M1-H01 19020-RWK-J01 19020-RJA-J01	KINFOR NO: CFHL21F5
	OE 19030-R60-U01 19030-R3L-G01 19030-50C-H01 19030-5G0-A01 19030-RL9-H01 19030-5M1-H01	KINFOR NO: CFHS15M

适用车型/APPLICATION :  
2016款 冠道 (水箱) /AVANCIER (RAD FAN)

## 冠道 (冷气) /AVANCIER (COND FAN)

2016



	OE 38615-5MS-H01-ZC	KINFOR NO: CFHL31
	OE 38615-5MS-H01	KINFOR NO: CFHL31S
	OE 38611-RL8-A01	KINFOR NO: CFHL13F7
	OE 38616-5MS-H01	KINFOR NO: CFHL31M

适用车型/APPLICATION :  
2016款 冠道 (冷气) /AVANCIER (COND FAN)

总成/ASSEMBLY

扇框/FAN-SHROUD

扇叶/FAN-BLADE





电机/FAN-MOTOR



艾力绅 (水箱) / ELYSION (RAD FAN)

2012







-  OE 19015-R28-H01-ZC KINFOR NO: CFHS10
-  OE 19015-R28-H01 KINFOR NO: CFHS10S
-  OE 19020-RCA-A01  
19020-R28-H01 KINFOR NO: CFHS18F5
-  OE 38616-RFE-003  
19030-R28-H01 KINFOR NO: CFHL09M
-  **适用车型/APPLICATION :**  
2012款 艾力绅(水箱) / ELYSION (RAD FAN)

艾力绅 (冷气) / ELYSION

2012







-  OE 38615-R28-H01-ZC KINFOR NO: CFHL10
-  OE 38615-R28-H01 KINFOR NO: CFHL10S
-  OE 38611-R40-A02  
38611-PFE-003  
38611-RFE-003  
38611-R40-A01 KINFOR NO: CFHL14F7
-  OE 38616-R28-H01 KINFOR NO: CFHL10M
-  **适用车型/APPLICATION :**  
2012款 艾力绅 (冷气) / ELYSION (COND FAN)

理念 (水箱) / EVERUS (RAD FAN)

2007-2008



-  OE 19015-REJ-H51-ZC KINFOR NO: CFHS04
-  OE 19015-REJ-H51 KINFOR NO: CFHS04S
-  OE 38611-RCA-A01  
38611-RCJ-A01 KINFOR NO: CFHL18F4
-  OE 19030-REJ-H51 KINFOR NO: CFHS04M
-  **适用车型/APPLICATION :**  
2007-2008款 理念 (水箱) / EVERUS (RAD FAN)

理念 (冷气) / EVERUS (COND FAN)

2007-2008



-  OE 38615-REJ-W02-ZC KINFOR NO: CFHL03
-  OE 38615-REJ-W02 KINFOR NO: CFHL03S
-  OE 38611-REJ-W01 KINFOR NO: CFHL03F7
-  OE 38616-REJ-W01 KINFOR NO: CFHL03M
-  **适用车型/APPLICATION :**  
2007-2008款 理念 (冷气) / EVERUS (COND FAN)

 总成/ASSEMBLY

 扇框/FAN-SHROUD

 扇叶/FAN-BLADE

 电机/FAN-MOTOR

## 凌派 (水箱) / CRIDER (RAD FAN) 1.0T

2019



- OE 19015-6P7-H01-ZC KINFOR NO: CFHS36
- OE 19015-6P7-H01 KINFOR NO: CFHS36S
- OE 19020-55A-Z01 KINFOR NO: CFHS06F5  
19020-5JE-J51
- OE 19030-6A0-A01 KINFOR NO: CFHS34M  
19030-6P7-H01

**适用车型/APPLICATION :**  
2019款 凌派(水箱)/CRIDER (RAD FAN) 1.0T

## 凌派 (冷气) / CRIDER (COND FAN) 1.0T

2019



- OE 8615-6P7-H01-ZC KINFOR NO: CFHL36
- OE 38615-6P7-H01 KINFOR NO: CFHL36S
- OE 38611-6P7-H01 KINFOR NO: CFHL36F7
- OE 38616-6A0-A01 KINFOR NO: CFHL34M  
38616-6P7-H01

**适用车型/APPLICATION :**  
2019款 凌派(冷气)/CRIDER (COND FAN) 1.0T

## 致在 (水箱) / ZRV (RAD FAN) 1.5T

2022-2023



- OE 19015-6CJ-H01-ZC KINFOR NO: CFHS52
- OE 19015-6CJ-H01 KINFOR NO: CFHS52S
- OE 19020-6CJ-H01 KINFOR NO: CFHS52F7
- OE 19030-6CJ-H01 KINFOR NO: CFHS52M

**适用车型/APPLICATION :**  
2022-2023款 致在(水箱)/ZRV (RAD FAN) 1.5T

## 致在 (冷气) / ZRV (COND FAN) 1.5T

2022-2023



- OE 38615-6CJ-H01-ZC KINFOR NO: CFHL52
- OE 38615-6CJ-H01 KINFOR NO: CFHL52S
- OE 38611-6CJ-H01 KINFOR NO: CFHL52F7
- OE 38616-6CJ-H01 KINFOR NO: CFHL52M

**适用车型/APPLICATION :**  
2022-2023款 致在(冷气) /ZRV (COND FAN) 1.5T

总成/ASSEMBLY

扇框/FAN-SHROUD





扇叶/FAN-BLADE

电机/FAN-MOTOR

山脊 (水箱) /RIDGELINE (RAD FAN)

2006-2008







-  OE 19015-RJE-A01-ZC KINFOR NO: CFHS80
-  OE 19015-RJE-A01 KINFOR NO: CFHS80S
-  OE 19020-RJE-A01 KINFOR NO: CFHS80F5
-  OE 19030-RJE-A01 KINFOR NO: CFHS80M

 适用车型/APPLICATION :  
2006-2008款 山脊 (水箱) /RIDGELINE (RAD FAN)

山脊 (冷气) /RIDGELINE (COND FAN)

2006-2008



-  OE 38615-RJE-A01-ZC KINFOR NO: CFHL80
-  OE 38615-RJE-A01 KINFOR NO: CFHL80S
-  OE 38611-RJE-A01 KINFOR NO: CFHL80F7
-  OE 38616-RJE-A01 KINFOR NO: CFHL80M

 适用车型/APPLICATION :  
2006-2008款 山脊 (冷气) /RIDGELINE (COND FAN)

山脊 (水箱) /RIDGELINE (RAD FAN) 3.5L

2009-2014





-  OE 19015-RN0-A01-ZC KINFOR NO: CFHS81
-  OE 19015-RN0-A01 KINFOR NO: CFHS81S
-  OE 19020-RN0-A71 KINFOR NO: CFHS81F5
-  OE 19030-RN0-A71 KINFOR NO: CFHS81M

 适用车型/APPLICATION :  
2009-2014款 山脊 (水箱) /RIDGELINE (RAD FAN) 3.5L

山脊 (冷气) /RIDGELINE (COND FAN) 3.5L

2009-2014



-  OE 38615-RN0-A01-ZC KINFOR NO: CFHL81
-  OE 38615-RN0-A01 KINFOR NO: CFHL81S
-  OE 38611-R70-A01 KINFOR NO: CFHL81F7
-  OE 38616-RN0-A51 KINFOR NO: CFHL81M

 适用车型/APPLICATION :  
2009-2014款 山脊 (冷气) /RIDGELINE (COND FAN) 3.5L

 总成/ASSEMBLY

 扇框/FAN-SHROUD

 扇叶/FAN-BLADE

 电机/FAN-MOTOR

## 讴歌 (冷气) /ACURA RDX ( COND FAN ) 2.3L

2007-2012



- OE 38615-RWC-A01-ZC KINFOR NO: CFHL89
- OE 38615-RWC-A01 KINFOR NO: CFHL89S
- OE 38611-RWC-A01 KINFOR NO: CFHL89F7
- OE 38616-RWC-A01 KINFOR NO: CFHL89M

**适用车型/APPLICATION :**  
2007-2012款 讴歌 (冷气)  
/ACURA RDX ( COND FAN ) 2.3L

## 讴歌 (水箱) /ACURA ZDX ( RAD FAN ) 3.7L

2010-2013



- OE 19015-RYE-A01-ZC KINFOR NO: CFHS97
- OE 19015-RYE-A01 KINFOR NO: CFHS97S
- OE 19020-RGL-A01 KINFOR NO: CFHS97F5
- OE 19030-RP6-A01 KINFOR NO: CFHS97M

**适用车型/APPLICATION :**  
2010-2013款 讴歌 (水箱)  
/ACURA ZDX ( RAD FAN ) 3.7L

## HR-V (水箱) /HR-V ( RAD FAN ) 1.8L

2016-2020



- OE 19015-51B-H01-ZC KINFOR NO: CFHS98
- OE 19015-51B-H01 KINFOR NO: CFHS98S
- OE 19020-RSA-G01 KINFOR NO: CFHS98F5
- OE 38616-5R1-003 KINFOR NO: CFHS98M

**适用车型/APPLICATION :**  
2016-2020款 HR-V (冷气) /HR-V ( COND FAN ) 1.8L

## 适用日产系列 FOR NISSAN SERIES

### 逍客/QASHQAI

2008-2014

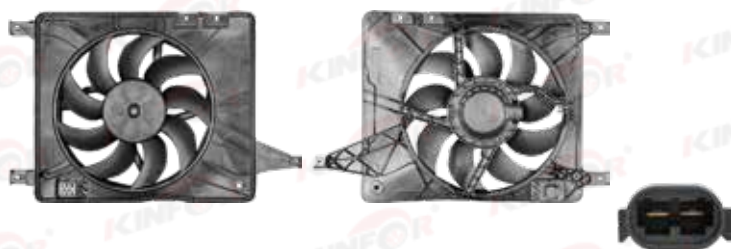

-  OE 21481-JE40A      KINFOR NO: CFRC01
-  OE 21483-JE20A      KINFOR NO: CFRC01S
-  OE 21486-JE20A      KINFOR NO: CFRC01F9
-  OE 21487-JE20A      KINFOR NO: CFRC01M
-  **适用车型/APPLICATION :**  
2008-2014款 逍客/QASHQAI

### 逍客/QASHQAI/ROGUE SPORT 2.0L 1.2T

2015



-  OE 21481-DF30A      KINFOR NO: CFRC18
-  OE                      KINFOR NO: CFRC18S
-  OE                      KINFOR NO: CFRC18F7
-  OE                      KINFOR NO: CFRC18M
-  **适用车型/APPLICATION :**  
2015款 逍客/QASHQAI 2.0L 1.2T  
/ROGUE SPORT 2.0L 1.2T

### 老风度/CEFIRO

2000-2005



-  OE 21481-5U015      KINFOR NO: CFRC17
-  OE 21483-4U100      KINFOR NO: CFRC17S
-  OE 21486-85E00/1L000      KINFOR NO: CFMC11F5  
21486-85E10/1L010      CFMC11F7  
Z6B215140
-  OE 21487-1L00A/9E000      KINFOR NO: CFRC16M
-  **适用车型/APPLICATION :**  
2000-2005款 老风度/CEFIRO

### 老蓝鸟/BLUE BIRD

2000-2005



-  OE 21481-0E010      KINFOR NO: CFRC15
-  OE 21483-0E600      KINFOR NO: CFRC15S
-  OE 21486-85E00/1L000      KINFOR NO: CFMC11F5  
21486-85E10/1L010      CFMC11F7  
Z6B215140
-  OE 21487-0E600      KINFOR NO: CFRC15M
-  **适用车型/APPLICATION :**  
2000-2005款 老蓝鸟/BLUE BIRD

 总成/ASSEMBLY

 扇框/FAN-SHROUD

 扇叶/FAN-BLADE

 电机/FAN-MOTOR

## 轩逸/SENTRA (MT) 1.6L

1991-1994



- OE 21481-51C00      KINFOR NO: CFRC37
- OE 21483-51C00      KINFOR NO: CFRC37S
- OE 21486-50Y00      KINFOR NO: CFRC37F5
- OE 21487-58Y01      KINFOR NO: CFRC37M

适用车型/APPLICATION :  
1991-1994款 轩逸/SENTRA 1.6L(MT)

## 轩逸/SENTRA 1.6L 2.0L

1995-1999



- OE 21481-4B100      KINFOR NO: CFRC44
- OE 21483-4B100      KINFOR NO: CFRC44S
- OE 21486-53J00      KINFOR NO: CFRC44F5
- OE 21487-58Y01      KINFOR NO: CFRC44M

适用车型/APPLICATION :  
1995-1999款 轩逸/SENTRA 1.6L 2.0L

## 轩逸/SENTRA

1996-2000



- OE 21481-F430A      KINFOR NO: CFRC38
- OE      KINFOR NO: CFRC38S
- OE      KINFOR NO: CFRC38F5
- OE      KINFOR NO: CFRC38M

适用车型/APPLICATION :  
1996-2000款 轩逸/SENTRA

## 轩逸/SENTRA 1.8L 2.0L

2000-2001



- OE 21481-6M100      KINFOR NO: CFRC43
- OE 21483-6M100      KINFOR NO: CFRC43S
- OE 21486-9E000      KINFOR NO: CFRC43F5  
21486-9E010      CFRC43F7
- OE 21487-0Z800      KINFOR NO: CFRC43M

适用车型/APPLICATION :  
2000-2001款 轩逸/SENTRA 1.8L 2.0L

轩逸/SENTRA 1.8L

2002-2006



-  OE 21481-4Z300      KINFOR NO: CFRC40
-  OE      KINFOR NO: CFRC40S
-  OE      KINFOR NO: CFRC40F5  
CFRC40F7
-  OE      KINFOR NO: CFRC40ML  
CFRC40MR
-  适用车型/APPLICATION :  
2002-2006款 轩逸/SENTRA 1.8L

轩逸/SENTRA 2.5L

2002-2006







-  OE 21481-4Z700      KINFOR NO: CFRC45
-  OE 21483-4Z700      KINFOR NO: CFRC45S
-  OE 21486-4Z700      KINFOR NO: CFRC45F5  
21486-4Z700      CFRC45F7
-  OE 21487-4Z700      KINFOR NO: CFRC45ML  
21487-4Z700      CFRC45MR
-  适用车型/APPLICATION :  
2002-2006款 轩逸/SENTRA 2.5L

轩逸/SENTRA 1.6L

2006-2011



-  OE 21481-EW80A/1FC5A      KINFOR NO: CFRC03
-  OE 21483-EW00A/1FA0A      KINFOR NO: CFRC03S
-  OE 21486-1FA0A      KINFOR NO: CFRC09F9
-  OE 21487-JN00B/ED80A      KINFOR NO: CFRC09M  
21487-JN00A/1FA0A
-  适用车型/APPLICATION :  
2007-2017款 轩逸1.6L/SENTRA 1.6L

轩逸/SYLPHY/SENTRA 2.0L

2008-2011

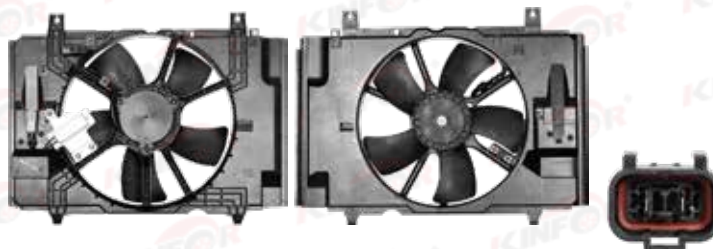

-  OE 21481-EW00B      KINFOR NO: CFRC04
-  OE 21483-EW00B      KINFOR NO: CFRC04S
-  OE 21486-EW00B      KINFOR NO: CFRC04F5
-  OE 21487-EW00B      KINFOR NO: CFRC04M
-  适用车型/APPLICATION :  
2008-2011款 轩逸/SYLPHY 2.0L/SENTRA 2.0L

 总成/ASSEMBLY

 扇框/FAN-SHROUD

 扇叶/FAN-BLADE

 电机/FAN-MOTOR

## 轩逸/SENTRA 2.0L

2007-2017



- OE 21481-ET000      KINFOR NO: CFRC46
- OE      KINFOR NO: CFRC46S
- OE      KINFOR NO: CFRC46F7
- OE      KINFOR NO: CFRC46ML  
CFRC46MR
- 适用车型/APPLICATION :**  
2007-2017款 轩逸/SENTRA 2.0L

## 轩逸/SENTRA 2.5L

2007-2017



- OE 21481-ET80B      KINFOR NO: CFRC47
- OE      KINFOR NO: CFRC47S
- OE      KINFOR NO: CFRC47F7
- OE      KINFOR NO: CFRC47ML  
CFRC47MR
- 适用车型/APPLICATION :**  
2007-2017款 轩逸/SENTRA 2.5L

## 轩逸/SYLPHY/SENTRA 1.6L

2012-2018



- OE 21481-3RA0A      KINFOR NO: CFRC02
- OE 21483-3RA0A      KINFOR NO: CFRC02S
- OE 21486-1FE0A      KINFOR NO: CFRC02F7
- OE 21487-1KA0A      KINFOR NO: CFRC02M
- 适用车型/APPLICATION :**  
2012-2018款 轩逸/SYLPHY 1.6L/SENTRA1.6L

## 轩逸/SYLPHY/SENTRA 1.8L

2012-2018

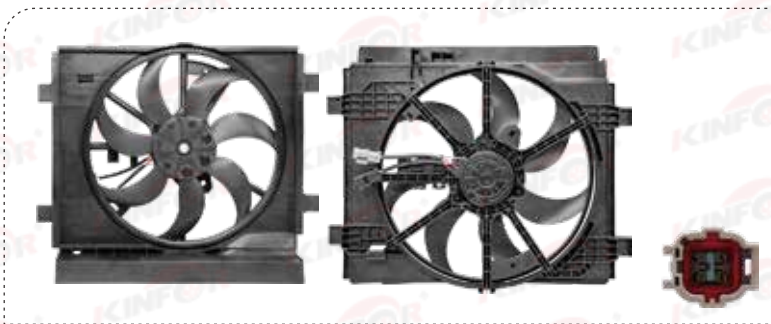

- OE 21481-3RA5A      KINFOR NO: CFRC05
- OE 21483-3RA5A      KINFOR NO: CFRC05S
- OE 21486-1HS3A      KINFOR NO: CFRC05F7
- OE 21487-3ST0A/1DA0A      KINFOR NO: CFRC05M
- 适用车型/APPLICATION :**  
2012-2018款 轩逸/SYLPHY 1.8L/SENTRA 1.8L

总成/ASSEMBLY

扇框/FAN-SHROUD

扇叶/FAN-BLADE





电机/FAN-MOTOR

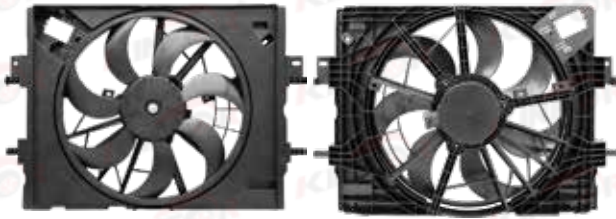

轩逸/SYLPHY/SENTRA 1.6L

2019



-  OE 21481-6LA0A KINFOR NO: CFRC22
-  OE 21483-6LA0A KINFOR NO: CFRC22S
-  OE 21486-5RF0B KINFOR NO: CFRC20F7
-  OE 21487-5RF0B KINFOR NO: CFRC20M

 适用车型/APPLICATION :  
2019款 轩逸/SYLPHY 1.6L /SENTRA1.6L

奇骏/X-TRAIL /ROGUE 2.0L 2.5L

2009-2013



-  OE 21481-1DB0A KINFOR NO: CFRC06
-  OE 21483-1DB0A KINFOR NO: CFRC06S
-  OE 21486-JN00A  
PEJD15140 KINFOR NO: CFRC06F9  
21486-JN00B CFRC06F11
-  OE 21487-3ST0A/1DA0A KINFOR NO: CFRC05M

 适用车型/APPLICATION :  
2009-2013款 奇骏/X-TRAIL ROGUE 2.0L 2.5L

奇骏/X-TRAIL /ROGUE

2014







-  OE 21481-4CL0A KINFOR NO: CFRC07
-  OE 21483-4CL0A KINFOR NO: CFRC07S
-  OE KINFOR NO: CFRC09F9  
CFRC07F7
-  OE 21487-JN00B/ED80A KINFOR NO: CFRC09M  
21487-JN00A/1FA0A

 适用车型/APPLICATION :  
2014款 奇骏/X-TRAIL/ROGUE

骐达/TIIDA

2006-2010



-  OE 21481-ED500/B KINFOR NO: CFRC08
-  OE 21483-ED500/B KINFOR NO: CFRC08S
-  OE 21486-ED000 KINFOR NO: CFRC08F5
-  OE 21487-ED80A/AX000 KINFOR NO: CFRC08M

 适用车型/APPLICATION :  
2006-2010款 骐达/TIIDA  
2005-2009款 颐达/TIIDA  
2007-2010款 骊威/LIVINA GENISS

 总成/ASSEMBLY

 扇框/FAN-SHROUD

 扇叶/FAN-BLADE

 电机/FAN-MOTOR

## 骐达/TIIDA 1.6T

2011



- OE 21480-3DD0A KINFOR NO: CFRC19
- OE 21483-1KC0A KINFOR NO: CFRC19S
- OE 21486-1FE0A KINFOR NO: CFRC02F7
- OE 21487-1KC0A KINFOR NO: CFRC19M

适用车型/APPLICATION :  
2011款 骐达/TIIDA 1.6T

## 骐达/TIIDA 1.6L

2012



- OE 21481-3DB0A KINFOR NO: CFRC09
- OE 21483-3DB0A KINFOR NO: CFRC09S
- OE 21486-1FA0A KINFOR NO: CFRC09F9
- OE 21487-JN00B/ED80A KINFOR NO: CFRC09M  
21487-JN00A/1FA0A

适用车型/APPLICATION :  
2012款 骐达/TIIDA 1.6L  
2013-2015款 骊威/LIVINA GENISS

## 天籁/ALTIMA

1998-2001



- OE 21481-0Z000 KINFOR NO: CFRC49
- OE KINFOR NO: CFRC49S
- OE KINFOR NO: CFRC49F5  
CFRC49F7
- OE KINFOR NO: CFRC49ML  
CFRC49MR

适用车型/APPLICATION :  
1998-2001款 天籁/ALTIMA

## 天籁/TEANA/ALTIMA

2003-2007



- OE 21481-9W200 KINFOR NO: CFRC10
- OE 21483-9W200 KINFOR NO: CFRC10S
- OE 21486-9W200 KINFOR NO: CFRC10F4  
21486-9W210 CFRC10F5
- OE 21487-ED80A/AX000 KINFOR NO: CFRC08M

适用车型/APPLICATION :  
2003-2007款 天籁/TEANA/ALTIMA

总成/ASSEMBLY

扇框/FAN-SHROUD

扇叶/FAN-BLADE

电机/FAN-MOTOR

天籁/TEANA/ALTIMA 2.0L 3.5L

2008-2012



-  OE 21481-JN01B      KINFOR NO: CFRC11
-  OE 21483-JN00A      KINFOR NO: CFRC11S
-  OE 21486-JN00A/L51715140      KINFOR NO: CFRC11F9  
21486-JN00B/L51615140      CFRC11F11
-  OE 21487-JN00B/ED80A      KINFOR NO: CFRC09M  
JN00A/1FA0A
-  **适用车型/APPLICATION :**  
2008-2012款 天籁/TEANA/ALTIMA 2.0L 3.5L

天籁/ALTIMA 2.5L 3.5L

2007-2018





-  OE 21481-JA000      KINFOR NO: CFRC50
-  OE 21483-9N00A      KINFOR NO: CFRC50S
-  OE 21486-JK60A      KINFOR NO: CFRC50F9  
21486-JK60B      CFRC50F11
-  OE 21487-ZX50A      KINFOR NO: CFRC50M
-  **适用车型/APPLICATION :**  
2007-2018款 天籁/ALTIMA 2.5L 3.5L

天籁/ALTIMA 2.0L

2019







-  OE 21481-6CT0A      KINFOR NO: CFRC23
-  OE      KINFOR NO: CFRC23S
-  OE      KINFOR NO: CFRC21F7  
CFRC21F9
-  OE      KINFOR NO: CFRC21M
-  **适用车型/APPLICATION :**  
2019款 天籁/ALTIMA 2.0L

天籁/ALTIMA 2.0T

2019



-  OE 21481-6CT1B      KINFOR NO: CFRC24
-  OE      KINFOR NO: CFRC24S
-  OE      KINFOR NO: CFRC24F8  
CFRC24F10
-  OE      KINFOR NO: CFRC24M
-  **适用车型/APPLICATION :**  
2019款 天籁/ALTIMA 2.0T

 总成/ASSEMBLY

 扇框/FAN-SHROUD

 扇叶/FAN-BLADE

 电机/FAN-MOTOR

## 阳光/SUNNY

2003-2007



- OE 21481-2N900      KINFOR NO: CFRC16
- OE 21483-5M005      KINFOR NO: CFRC16S
- OE 21486-85E00/1L000      KINFOR NO: CFMC11F5  
21486-85E10/1L010      CFMC11F7  
Z6B215140
- OE 21487-1L00A/9E000      KINFOR NO: CFRC16M
- 适用车型/APPLICATION :**  
22003-2007款 老阳光/SUNNY

## 阳光/SUNNY

2010-2013

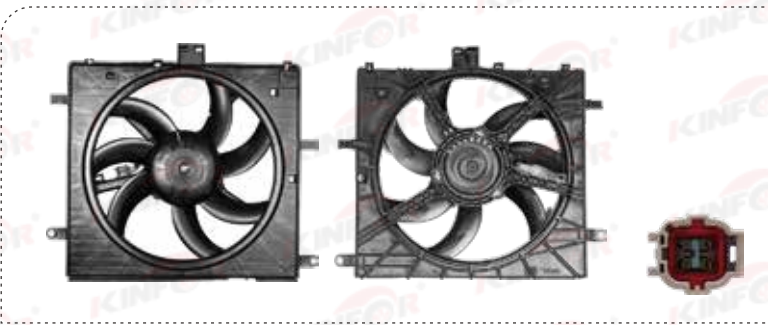

- OE 21481-1HS2A/B      KINFOR NO: CFRC12
- OE 21483-1HS2A      KINFOR NO: CFRC12S
- OE 21486-1HC0A      KINFOR NO: CFRC12F7
- OE 21487-1HS0A      KINFOR NO: CFRC12M
- 适用车型/APPLICATION :**  
2010-2013款 阳光/SUNNY

## 阳光/SUNNY

2013-2015



- OE 21481-3AU1C      KINFOR NO: CFRC83
- OE      KINFOR NO: CFRC83S
- OE 21483-3AU1A      KINFOR NO: CFRC83F7
- OE      KINFOR NO: CFRC83M
- 适用车型/APPLICATION :**  
2013-2015款 阳光/SUNNY

## 新阳光/VERSA 1.6L 1.8L

2007-2013



- OE 21481-EL30A      KINFOR NO: CFRC51
- OE 21483-EL30A      KINFOR NO: CFRC51S
- OE 21486-EW00B      KINFOR NO: CFRC51F5
- OE 21487-EW00B      KINFOR NO: CFRC51M
- 适用车型/APPLICATION :**  
2007-2013款 阳光/VERSA 1.6L 1.8L

总成/ASSEMBLY

扇框/FAN-SHROUD

扇叶/FAN-BLADE

电机/FAN-MOTOR

新阳光/VERSA (单插)

2014-2018



-  OE 21481-1HS3A KINFOR NO: CFRC31
-  OE 21483-1HS3A KINFOR NO: CFRC31S
-  OE 21486-1HS3A KINFOR NO: CFRC05F7
-  OE 21487-1HS3D KINFOR NO: CFRC31M
-  **适用车型/APPLICATION :**  
2012-2019款 阳光/VERSA (单插)

新阳光/VERSA (双插)

2012-2019



-  OE 21481-3AB3A/9KK0A KINFOR NO: CFRC32
-  OE 21483-1HS3A KINFOR NO: CFRC31S
-  OE 21486-1FE0A KINFOR NO: CFRC02F9
-  OE 21487-1KA0E KINFOR NO: CFRC32M
-  **适用车型/APPLICATION :**  
2012-2019款 阳光/VERSA (双插)

新阳光/VERSA

2020-2022







-  OE 21481-5RB0B KINFOR NO: CFRC52
-  OE KINFOR NO: CFRC52S
-  OE KINFOR NO: CFRC52F7
-  OE 21487-JF00B KINFOR NO: CFRC52M
-  **适用车型/APPLICATION :**  
2020-2022款 阳光/VERSA

启辰/VELOCIA D50

2012



-  OE 21481-2FJ0A KINFOR NO: CFRC14
-  OE 21483-2FJ0A KINFOR NO: CFRC14S
-  OE KINFOR NO: CFRC14F5
-  OE B1487-2FJ0A KINFOR NO: CFRC14M
-  **适用车型/APPLICATION :**  
2012款 启辰/VELOCIA D50

 总成/ASSEMBLY

 扇框/FAN-SHROUD

 扇叶/FAN-BLADE

 电机/FAN-MOTOR

## 东风日产/JUKE 1.6L

2010-2019



- OE 21481-1KA0A      KINFOR NO: CFRC25
- OE 21483-EW00A      KINFOR NO: CFRC03S
- OE      KINFOR NO: CFRC07F7
- OE      KINFOR NO: CFRC25M

**适用车型/APPLICATION :**  
2010-2019款 东风日产/JUKE 1.6L

## 劲客/KICKS 1.5L

2017

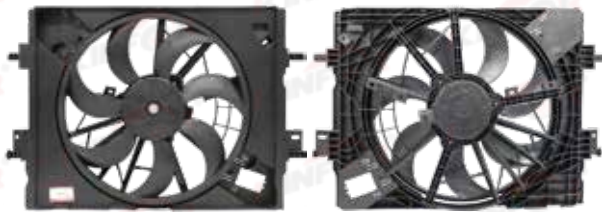

- OE 21481-5RF0B      KINFOR NO: CFRC20
- OE 21483-5RF0A      KINFOR NO: CFRC20S
- OE 21486-5RF0B      KINFOR NO: CFRC20F7
- OE 21487-5RF0B      KINFOR NO: CFRC20M

**适用车型/APPLICATION :**  
2017款 劲客/KICKS 1.5L

## 劲客/KICKS 1.6L

2017



- OE 21481-5RB0B      KINFOR NO: CFRC52
- OE      KINFOR NO: CFRC52S
- OE      KINFOR NO: CFRC52F7
- OE 21487-JF00B      KINFOR NO: CFRC52M

**适用车型/APPLICATION :**  
2017款 劲客/KICKS 1.6L

## 楼兰/MURANO 2.5L

2015



- OE 21481-5BC0A      KINFOR NO: CFRC21
- OE      KINFOR NO: CFRC21S
- OE      KINFOR NO: CFRC21F9  
CFRC21F7
- OE      KINFOR NO: CFRC21M

**适用车型/APPLICATION :**  
2015款 楼兰/MURANO 2.5L

总成/ASSEMBLY

扇框/FAN-SHROUD

扇叶/FAN-BLADE

电机/FAN-MOTOR

西玛/MAXIMA 2.5L 3.5L

2004-2008



-  OE 21481-8J000      KINFOR NO: CFRC59
-  OE 21483-8J000      KINFOR NO: CFRC59S
-  OE 21486-8J000      KINFOR NO: CFRC59F5  
21486-8J010      CFRC59F4
-  OE 21487-8J000      KINFOR NO: CFRC59ML  
21487-8J010      CFRC59MR
-  **适用车型/APPLICATION :**  
2004-2008款 西玛/MAXIMA 2.5L 3.5L

西玛/MAXIMA 3.5L

2009-2015



-  OE 21481-9N00A      KINFOR NO: CFRC63
-  OE 21483-9N00A      KINFOR NO: CFRC63S
-  OE 21486-JK60B      KINFOR NO: CFRC63F11  
21486-JK60A      CFRC63F9
-  OE 21487-JAA0A      KINFOR NO: CFRC63M
-  **适用车型/APPLICATION :**  
2009-2015款 西玛/MAXIMA 3.5L

英菲尼迪/INFINITI FX35

2009



-  OE 21481-JK600      KINFOR NO: CFRC67
-  OE 21483-JK00A      KINFOR NO: CFRC67S
-  OE 21486-JK60A      KINFOR NO: CFRC67F9  
21486-JK60B      CFRC67F11
-  OE 21487-JK60E      KINFOR NO: CFRC67ML  
21487-JK61A      CFRC67MR
-  **适用车型/APPLICATION :**  
2009款 英菲尼迪/INFINITI FX35

英菲尼迪/INFINITI FX45

2003-2008



-  OE 21481-CG000      KINFOR NO: CFRC68
-  OE      KINFOR NO: CFRC68S
-  OE      KINFOR NO: CFRC68F7
-  OE      KINFOR NO: CFRC68M
-  **适用车型/APPLICATION :**  
2003-2008款 英菲尼迪/INFINITI FX45

 总成/ASSEMBLY

 扇框/FAN-SHROUD

 扇叶/FAN-BLADE

 电机/FAN-MOTOR

英菲尼迪/INFINITI FX50

2009-2013



- OE 21481-1BH0B KINFOR NO: CFRC69
- OE KINFOR NO: CFRC69S
- OE KINFOR NO: CFRC69F9  
CFRC69F11
- OE KINFOR NO: CFRC69ML  
CFRC69MR
- 适用车型/APPLICATION :  
2009-2013款 英菲尼迪/INFINITI FX50

英菲尼迪/INFINITI JX35 3.5L

2013



- OE 21481-3JA2E KINFOR NO: CFRC71
- OE KINFOR NO: CFRC71S
- OE KINFOR NO: CFRC71F7
- OE KINFOR NO: CFRC71M
- 适用车型/APPLICATION :  
2013款 英菲尼迪/INFINITI GX35 3.5L

英菲尼迪/INFINITI ESQ 1.6T

2014

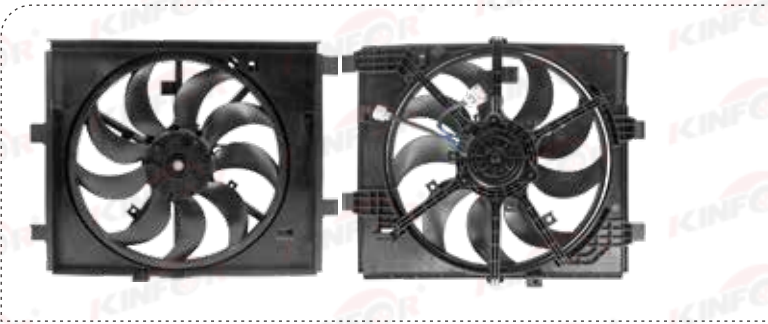

- OE 21481-1KC0A KINFOR NO: CFRC19
- OE 21483-1KC0A KINFOR NO: CFRC19S
- OE 21486-1FE0A KINFOR NO: CFRC02F9
- OE 21487-1KC0A KINFOR NO: CFRC19M
- 适用车型/APPLICATION :  
2014款 英菲尼迪/INFINITI ESQ 1.6T

英菲尼迪/INFINITI ESQ 1.6L

2014-2016



- OE 21481-EW00A KINFOR NO: CFRC33
- OE 21483-EW00A KINFOR NO: CFRC03S
- OE 21486-1FA0A KINFOR NO: CFRC09F9
- OE 21487-1KA0A KINFOR NO: CFRC02MC
- 适用车型/APPLICATION :  
2014-2016款 英菲尼迪/INFINITI ESQ 1.6L

总成/ASSEMBLY

扇框/FAN-SHROUD

扇叶/FAN-BLADE

电机/FAN-MOTOR



楼兰/MURANO

2007-2013



- 
- 
- 
- 
- 
- 

**适用车型/APPLICATION :**  
2007-2013款 楼兰/MURANO

楼兰/MURANO 3.5L

2009-2014



- 
- 
- 
- 
- 
- 

**适用车型/APPLICATION :**  
2009-2014款 楼兰/MURANO 3.5L

电子风扇  
Cooling Fan Assembly

🌀 总成/ASSEMBLY

🌀 扇框/FAN-SHROUD

🌀 扇叶/FAN-BLADE

🌀 电机/FAN-MOTOR



电子风扇  
Cooling Fan Assembly

总成/ASSEMBLY

扇框/FAN-SHROUD

扇叶/FAN-BLADE

电机/FAN-MOTOR

## 适用马自达系列 FOR MAZDA SERIES

### 马自达2/MAZDA 2

2008-2014



-  OE ZJ3615025F KINFOR NO: CFMC01
-  OE KINFOR NO: CFMC01S
-  OE KINFOR NO: CFMC01F7
-  OE KINFOR NO: CFMC01M
-  **适用车型/APPLICATION :**  
2008-2014款 马自达2/MAZDA 2

### 马自达3/MAZDA 3

2006-2012



-  OE LFN715025B KINFOR NO: CFMC04
-  OE KINFOR NO: CFMC04S
-  OE KINFOR NO: CFGC02F8
-  OE KINFOR NO: CFMC04M
-  **适用车型/APPLICATION :**  
2006-2012款 马自达3/MAZDA 3

### 马自达5/MAZDA 5

2008-2010





-  OE LFB715025C KINFOR NO: CFMC09
-  OE LFB715210 KINFOR NO: CFMC09S
-  OE LFB715140 KINFOR NO: CFMC09F7
-  OE LFB715150 KINFOR NO: CFMC09M
-  **适用车型/APPLICATION :**  
2008-2010款 马自达5/MAZDA 5

### 马自达5/MAZDA 5

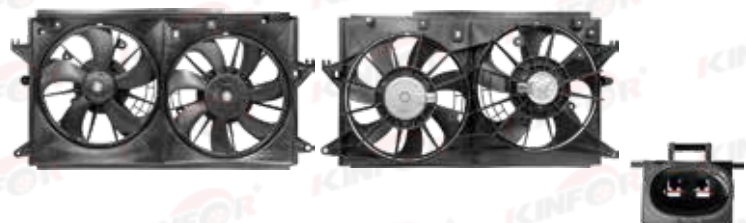
2011



-  OE LFDV15025B/A KINFOR NO: CFMC06
-  OE LFDV15210A KINFOR NO: CFMC06S
-  OE LFDV15140  
L84515140 KINFOR NO: CFMC06F5  
CFMC06F7
-  OE LF4T-15-150A KINFOR NO: CFMC06ML  
CFMC08M
-  **适用车型/APPLICATION :**  
2011款 马自达5/MAZDA 5

 总成/ASSEMBLY

 扇框/FAN-SHROUD

 扇叶/FAN-BLADE

 电机/FAN-MOTOR

## 马自达6/MAZDA 6 2003-2012



- OE 5AA015025 KINFOR NO: CFMC11

---

- OE L33015210 KINFOR NO: CFMC11S

---

- OE 21486-85E00/1L000 KINFOR NO: CFMC11F5  
21486-85E10/1L010 CFMC11F7  
Z6B215140

---

- OE L32915150 KINFOR NO: CFMC11M

---

- 适用车型/APPLICATION :**  
2003-2012款 马自达6/MAZDA 6

## 马自达3星骋/MAZDA 3 1.6L 2011



- OE Z6B315025 KINFOR NO: CFMC02

---

- OE Z6B215210 KINFOR NO: CFMC02S

---

- OE 21486-85E10/1L010 KINFOR NO: CFMC11F7  
Z6B215140 CFMC02F5  
Z6B315140

---

- OE Z6B215150 KINFOR NO: CFMC02M  
Z6B315150

---

- 适用车型/APPLICATION :**  
2011款 马自达3星骋/MAZDA 3 1.6L

## 昂克赛拉/MAZDA 3 2014-2018



- OE PEDT15025 KINFOR NO: CFMC05

---

- OE PEDT15210 KINFOR NO: CFMC05S

---

- OE PE7W15140 KINFOR NO: CFMC03F7  
PEAJ15140 CFMC03F9  
PE8B15140  
PEAK15140

---

- OE PEAJ15150 KINFOR NO: CFMC03ML  
PEAK15150A CFMC03MR

---

- 适用车型/APPLICATION :**  
2014-2018 款昂克赛拉/MAZDA 3

## 昂克赛拉/MAZDA 3 2019



- OE P5J115025 KINFOR NO: CFMC13

---

- OE KINFOR NO: CFMC13S

---

- OE KINFOR NO: CFMC13F7

---

- OE PAF115150 KINFOR NO: CFMC13M

---

- 适用车型/APPLICATION :**  
2019款 昂克赛拉/MAZDA 3

阿特兹/MAZDA 6 ATENZA 2.0L

2014





	OE PEAJ15025A	KINFOR NO: CFMC10
	OE PEAJ15210	KINFOR NO: CFMC01S
	OE PE7W15140 PEAJ15140 PE8B15140 PEAK15140	KINFOR NO: CFMC03F7 CFMC03F9
	OE PEAJ15150 PEAK15150A	KINFOR NO: CFMC03ML CFMC03MR

 适用车型/APPLICATION :  
2014款 阿特兹/ MAZDA 6 ATENZA 2.0L

CX-5

2013





	OE PE7W15025	KINFOR NO: CFMC03
	OE PE7W15210	KINFOR NO: CFMC03S
	OE PE7W15140 PEAJ15140 PE8B15140 PEAK15140	KINFOR NO: CFMC03F7 CFMC03F9
	OE PEAJ15150 PEAK15150A	KINFOR NO: CFMC03ML CFMC03MR

 适用车型/APPLICATION :  
2013款 CX-5

CX-4

2015



	OE PEJC15025	KINFOR NO: CFMC12
	OE PEJC15210	KINFOR NO: CFMC12S
	OE PEJC15140 21486-JN00A PEJD15140	KINFOR NO: CFMC12F7 CFRC06F9
	OE PEJD15150 PEJC15150	KINFOR NO: CFMC12ML CFMC12MR

 适用车型/APPLICATION :  
2015款 CX-4

睿翼/MAZDA 6 2.0L

2008-2014



	OE LF4L15025C	KINFOR NO: CFMC07
	OE LF4L15210A	KINFOR NO: CFMC07S
	OE ZJ0115140 19020-R60-U01 LF4L15140	KINFOR NO: CFMC07F5 CFSH15F7
	OE	KINFOR NO: CFMC07M

 适用车型/APPLICATION :  
2008-2014款 睿翼/ MAZDA 6 2.0L

 总成/ASSEMBLY

 扇框/FAN-SHROUD

 扇叶/FAN-BLADE

 电机/FAN-MOTOR

## 睿翼/MAZDA 6 2.5L

2008-2014



	OE L51715025C	KINFOR NO: CFMC08
	OE L51715210A	KINFOR NO: CFMC08S
	OE 21486-JN00A L51715140 21486-JN00B L51615140	KINFOR NO: CFRC11F9 CFRC11F11
	OE 21481-6CT0A	KINFOR NO: CFRC05M

适用车型/APPLICATION :  
2008-2014款 睿翼/ MAZDA 6 2.5L

## MAZDA 3/L4 122 2.0L 2.3L

2004-2009



	OE Z60215025B/C/D Z60215025E/F/G	KINFOR NO: CFMC16
	OE	KINFOR NO: CFMC16S
	OE	KINFOR NO: CFMC16F7
	OE	KINFOR NO: CFMC16M

适用车型/APPLICATION :  
2004-2009款 MAZDA 3/L4 122 2.0L 2.3L

## MAZDA 3/L4 2.0L 2.5L

2010-2013



	OE R2AH15025C/E/G	KINFOR NO: CFMC17
	OE	KINFOR NO: CFMC17S
	OE	KINFOR NO: CFMC17F7
	OE	KINFOR NO: CFMC17M

适用车型/APPLICATION :  
2010-2013款 MAZDA 3/L4 2.0L 2.5L

## MAZDA 3/L4 2.0L 2.5L

2014-2018



	OE PE2015025	KINFOR NO: CFMC30
	OE PE2015210	KINFOR NO: CFMC30S
	OE PE2015140 PE2115140	KINFOR NO: CFMC30F7
	OE PE2015150 PE2115150	KINFOR NO: CFMC30ML CFMC30MR

适用车型/APPLICATION :  
2014-2018款 MAZDA 3/L4 2.0L 2.5L

总成/ASSEMBLY

扇框/FAN-SHROUD

扇叶/FAN-BLADE

电机/FAN-MOTOR

MAZDA 3/L4 2.5L

2019-2020

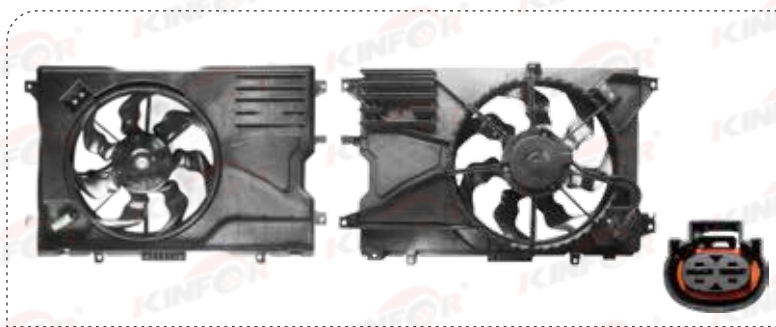

-  OE PAF115025A KINFOR NO: CFMC19
-  OE KINFOR NO: CFMC19S
-  OE KINFOR NO: CFMC19F7
-  OE KINFOR NO: CFMC19M

 适用车型/APPLICATION :  
2019-2020款 MAZDA 3/L4 2.5L

MAZDA 6/L4 152 2.5L

2014-2017



-  OE PE1115025  
PE1115025A KINFOR NO: CFMC15
-  OE PE1115210 KINFOR NO: CFMC15S
-  OE PE1115140  
PE1215140 KINFOR NO: CFMC15F9  
CFMC15F11
-  OE PE1115150  
PE1215150A KINFOR NO: CFMC15ML  
CFMC15MR

 适用车型/APPLICATION :  
2014-2017款 MAZDA 6/L4 152 2.5L

MAZDA 6/V6 181 3.0L

2003-2008



-  OE AJ5715025C/D/E/F  
/G/H/J/K/L/M/N  
AJB415025/A/B/C/D/E KINFOR NO: CFMC23
-  OE AJ5715210C KINFOR NO: CFMC23S
-  OE FS1G15140  
FS1H15140 KINFOR NO: CFMC23F5  
CFMC23F7
-  OE AJ5715150A  
AJ5815150 KINFOR NO: CFMC23ML  
CFMC23MR

 适用车型/APPLICATION :  
2003-2008款 MAZDA 6/V6 181 3.0L

MAZDA CX-7

2007-2009

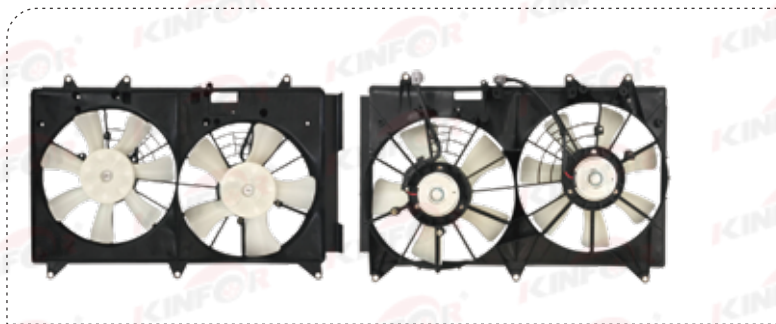

-  OE L33L15025C/D/E KINFOR NO: CFMC29
-  OE L3BT15210 KINFOR NO: CFMC29S
-  OE L33L15140  
L33M15140 KINFOR NO: CFMC29F5  
CFMC29F7
-  OE L33L15150D KINFOR NO: CFMC29ML  
CFMC29MR

 适用车型/APPLICATION :  
2007-2009款 MAZDA CX-7

 总成/ASSEMBLY

 扇框/FAN-SHROUD

 扇叶/FAN-BLADE

 电机/FAN-MOTOR

## MAZDA CX-7/L4 152 2.5L

2010-2012

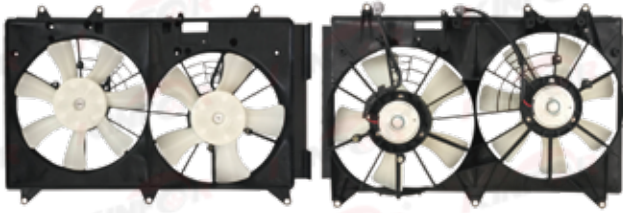

- OE L55515025A L55515025B KINFOR NO: CFMC31
- OE L55515210 KINFOR NO: CFMC31S
- OE CY0115140A KINFOR NO: CFMC31F7
- OE R2AX15150A KINFOR NO: CFMC31M

适用车型/APPLICATION :  
2010-2012款 MAZDA CX-7

## MAZDA CX-9/V6 213 3.5L/V6 227 3.7L

2007-2015



- OE CY0115025E CY0115025F KINFOR NO: CFMC46
- OE CY0115210B KINFOR NO: CFMC46S
- OE CY0215140A KINFOR NO: CFMC46F7
- OE CY0215150A CY0115150A KINFOR NO: CFMC46ML  
CFMC46MR

适用车型/APPLICATION :  
2007-2015款 MAZDA CX-9/V6 213 3.5L /V6 227 3.7L

## MAZDA TRIBUTE/V6 181 3.0L

2001-2006



- OE AJ0515026/A AJ0515025/A/D/E/F/G AJ0515035/A/B/C AJ0615025/A KINFOR NO: CFMC20
- OE KINFOR NO: CFMC20S
- OE KINFOR NO: CFMC20F5  
CFMC20F6
- OE KINFOR NO: CFMC20ML  
CFMC20MR

适用车型/APPLICATION :  
2001-2006款 MAZDA TRIBUTE/V6 181 3.0L

## MAZDA MPV

2000-2001



- OE GY0115025A/B/C GY0115025D/E/F KINFOR NO: CFMC27
- OE GY0115210B KINFOR NO: CFMC27S
- OE GY0115140 GY0715140 KINFOR NO: CFMC27F5  
CFMC27F7
- OE KLP115150 KINFOR NO: CFMC27ML  
CFMC27MR

适用车型/APPLICATION :  
2000-2001款 MAZDA MPV

总成/ASSEMBLY

扇框/FAN-SHROUD

扇叶/FAN-BLADE

电机/FAN-MOTOR



MAZDA PROTEGE5/L4 1.8L

2002-2003



OE B595-15-035C  
BPD315035/A/B/C

KINFOR NO: CFMC43

OE B59515210A

KINFOR NO: CFMC43S

OE B59515140

KINFOR NO: CFMC43F5

OE B59515150A

KINFOR NO: CFMC43M

适用车型/APPLICATION :  
2002-2003款 MAZDA PROTEGE5

MAZDA PROTEGE/L4 2.0L

2001-2003



OE FS2V15035A/B/C  
FS2V15035D/F

KINFOR NO: CFMC45

OE ZM0515210A

KINFOR NO: CFMC45S

OE RF1S15140

KINFOR NO: CFMC45F7

OE RF1S15150

KINFOR NO: CFMC45M

适用车型/APPLICATION :  
2001-2003 MAZDA PROTEGE/ L4 2.0L

MAZDA RX-8

2004-2008



OE N3H115025C  
N3H115025D  
N3H115025E  
N3H115025F

KINFOR NO: CFMC44

OE

KINFOR NO: CFMC44S

OE

KINFOR NO: CFMC44F5  
CFMC44F7

OE

KINFOR NO: CFMC44ML  
CFMC44MR

适用车型/APPLICATION :  
2004-2008款 Mazda RX-8



电子风扇  
Cooling Fan Assembly

总成/ASSEMBLY

扇框/FAN-SHROUD

扇叶/FAN-BLADE

电机/FAN-MOTOR

# 适用大众系列 FOR VOLKSWAGEN SERIES

## 宝来/BORA

2003-2005

 OE 1J0959455D KINFOR NO: CFVC03

 OE KINFOR NO:

 OE KINFOR NO:

 OE KINFOR NO:

 适用车型/APPLICATION :  
2003-2005款 宝来/BORA

## 宝来/BORA

2005-2010



 OE 1K0121207BB KINFOR NO: CFVC11

 OE KINFOR NO: CFVC11S

 OE KINFOR NO: CFVC11F7

 OE KINFOR NO: CFVC11M

 适用车型/APPLICATION :  
2005-2010款 宝来/BORA  
2005-2010款 帕萨特/PASSAT  
2005-2010款 高尔夫/GOLF  
2005-2010款 甲壳虫/BEETLE  
2008-2018款 捷达/JETTA 2.0L

## 捷达/JETTA

1998-2008



 OE MVVJE99C KINFOR NO: CFVC12

 OE KINFOR NO: CFVC12S

 OE KINFOR NO: CFVC12F6  
CFVC12F9

 OE KINFOR NO: CFVC12ML  
CFVC12MR

 适用车型/APPLICATION :  
1998-2008款 捷达/JETTA  
1998-2008款 高尔夫/GOLF

## 捷达/JETTA

2013-2019



 OE 6RD959455A KINFOR NO: CFVC02

 OE KINFOR NO:

 OE KINFOR NO:

 OE KINFOR NO:

 适用车型/APPLICATION :  
2013-2019款 捷达/JETTA

 总成/ASSEMBLY

 扇框/FAN-SHROUD

 扇叶/FAN-BLADE

 电机/FAN-MOTOR

**波罗/POLO** **2003-2009**



- OE 682-WVU002 KINFOR NO: CFVC14

---

- OE KINFOR NO:

---

- OE KINFOR NO:

---

- OE KINFOR NO:

---

- 适用车型/APPLICATION :**  
2003-2009款 波罗/POLO

**波罗/POLO** **2010-2014**



- OE 6R0-949-455C KINFOR NO: CFVC16

---

- OE KINFOR NO: CFVC16S

---

- OE KINFOR NO: CFVC16F7

---

- OE KINFOR NO: CFVC16M

---

- 适用车型/APPLICATION :**  
2003-2009款 波罗/POLO

**波罗/POLO 1.2L 1.6L** **2013-2017**



- OE 6R0121207N KINFOR NO: CFVC13

---

- OE KINFOR NO: CFVC13S

---

- OE KINFOR NO: CFVC13F7

---

- OE KINFOR NO: CFVC13M

---

- 适用车型/APPLICATION :**  
2003-2009款 波罗/POLO 1.2L 1.6L

**高尔夫/GOL** **2009-2016**



- OE 5U0121205D KINFOR NO: CFVC17

---

- OE KINFOR NO: CFVC17S

---

- OE KINFOR NO: CFVC17F9

---

- OE KINFOR NO: CFVC17M

---

- 适用车型/APPLICATION :**  
2009-2016款 高尔夫/GOL

朗逸/LAVIDA

2006-2012



OE 1TD121203A  
1K0959455R  
1K0121207T

KINFOR NO: CFVC05

OE KINFOR NO: CFVC05S

OE KINFOR NO: CFVC05F7L  
CFVC05F7R

OE KINFOR NO: CFVC05ML  
CFVC05MR

适用车型/APPLICATION :  
2006-2012款 朗逸/LAVIDA

朗逸/LAVIDA

2015-2022



OE 1TD959455  
3C0959455F

KINFOR NO: CFVC01L

OE KINFOR NO:

OE KINFOR NO:

OE KINFOR NO:

适用车型/APPLICATION :  
2015-2022款 朗逸/LAVIDA

朗逸/LAVIDA

2015-2022



OE 3C0959455G

KINFOR NO: CFVC01R

OE KINFOR NO:

OE KINFOR NO:

OE KINFOR NO:

适用车型/APPLICATION :  
2015-2022款 朗逸/LAVIDA

迈腾/MAGOTAN

2006-2012



OE 1K0121205J  
1K0959455A

KINFOR NO: CFVC06

OE KINFOR NO: CFVC06S

OE KINFOR NO: CFVC06F7

OE KINFOR NO: CFVC06M

适用车型/APPLICATION :  
2006-2012款 迈腾/MAGOTAN

总成/ASSEMBLY

扇框/FAN-SHROUD

扇叶/FAN-BLADE

电机/FAN-MOTOR

大众LEON L4 1.4L 1.8L 2.0L

2012-2018



- OE 5Q0121203DE KINFOR NO: CFVC10

---

- OE KINFOR NO: CFVC10S

---

- OE KINFOR NO: CFVC10F7

---

- OE KINFOR NO: CFVC10M

**适用车型/APPLICATION :**  
2012-2018款 大众LEON L4 1.4L 1.8L 2.0L

电子风扇  
Cooling Fan Assembly

## 适用现代起亚系列 FOR HYUNDAI/KIA SERIES

### 伊兰特 (水箱) /ELANTRA(RAD FAN)

2005-2008



	OE 25380-2C600	KINFOR NO: CFHY18
	OE 25350-2D400	KINFOR NO: CFHY18S
	OE 25231-2D400	KINFOR NO: CFHY18F5
	OE 25386-2C600	KINFOR NO: CFHY18M

**适用车型/APPLICATION :**  
2005-2008款 伊兰特 (水箱) /ELANTRA (RAD FAN)

### 伊兰特 (冷气) /ELANTRA(COND FAN)

2005-2008



	OE 97730-2C000	KINFOR NO: CFHY13
	OE 97735-2D000	KINFOR NO: CFHY13S
	OE 97737-25000	KINFOR NO: CFHY13F6
	OE 97786-2C000	KINFOR NO: CFHY13M

**适用车型/APPLICATION :**  
2005-2008款 伊兰特 (冷气) /ELANTRA (COND FAN)

### 伊兰特/ELANTRA 1.8L 2.0L

2014-2016



	OE 25380-3X500	KINFOR NO: CFHY10
	OE 25350-3X500	KINFOR NO: CFHY10S
	OE 25231-0U390	KINFOR NO: CFHY10F7
	OE 25386-B2100	KINFOR NO: CFHY10M

**适用车型/APPLICATION :**  
2014-2016款 伊兰特/ELANTRA 1.8L 2.0L  
2014-2016款 福瑞迪/FORTE

### 索塔纳 (水箱) /SONATA(RAD FAN)

2003-2005



	OE 25380-3D180	KINFOR NO: CFHY19
	OE 25350-38000	KINFOR NO: CFHY19S
	OE 25231-38000	KINFOR NO: CFHY19F7
	OE 25386-38050	KINFOR NO: CFHY19M

**适用车型/APPLICATION :**  
2003-2005款 索塔纳 (水箱) /SONATA (RAD FAN)

总成/ASSEMBLY

扇框/FAN-SHROUD

扇叶/FAN-BLADE

电机/FAN-MOTOR

索塔纳 (冷气) /SONATA(COND FAN)

2003-2005



- OE 97730-38000 KINFOR NO: CFHY16
- OE 97735-38000 KINFOR NO: CFHY16S
- OE 97731-38000 KINFOR NO: CFHY16F7
- OE 97786-38000 KINFOR NO: CFHY16M

适用车型/APPLICATION :  
2003-2005款 索塔纳 (冷气) /SONATA (COND FAN)

索塔纳(美国款)/SONATA (USA)

2015



- OE 25380-C2000 KINFOR NO: CFHY04
- OE KINFOR NO: CFHY04S
- OE KINFOR NO: CFHY04F5
- OE KINFOR NO: CFHY04M

适用车型/APPLICATION :  
2015款 索塔纳(美国款)/SONATA (USA)

索塔纳/SONATA 1.6L 2.0L

2015-2018



- OE 25380-C2100 KINFOR NO: CFHY05
- OE 25350-C2100 KINFOR NO: CFHY05S
- OE 25231-C2100 KINFOR NO: CFHY05F5
- OE 25386-C2100 KINFOR NO: CFHY05M

适用车型/APPLICATION :  
2015-2018款 索塔纳/SONATA 1.6L 2.0L

雅绅特/ACCENT

2007-2010



- OE 25380-1E100 KINFOR NO: CFHY20
- OE 25350-1E100 KINFOR NO: CFHY20S
- OE 25231-1C333 KINFOR NO: CFHY20F7
- OE 25386-1E100 KINFOR NO: CFHY20M

适用车型/APPLICATION :  
2007-2010款 雅绅特/ACCENT

总成/ASSEMBLY

扇框/FAN-SHROUD

扇叶/FAN-BLADE

电机/FAN-MOTOR



雅绅特/ACCENT

2015-2017



OE 25380-1R050  
25380-1R600  
25380-1V050

KINFOR NO: CFHY14

OE 25350-1R050

KINFOR NO: CFHY14S

OE 25231-1R390

KINFOR NO: CFHY14F7

OE 25386-1R140

KINFOR NO: CFHY14M

**适用车型/APPLICATION :**  
2015-2017款 雅绅特/ACCENT

途胜/TUCSON

2005-2008



OE 25380-1F380

KINFOR NO: CFHY23

OE 25350-0L000

KINFOR NO: CFHY23S

OE 25231-2E000

KINFOR NO: CFHY23F7

OE 25386-0L300

KINFOR NO: CFHY23M

**适用车型/APPLICATION :**  
2005-2008款 途胜/TUCSON

途胜/TUCSON

2011-2015



OE 25380-2S500

KINFOR NO: CFHY11

OE

KINFOR NO: CFHY11S

OE

KINFOR NO: CFHY11F7

OE

KINFOR NO: CFHY11M

**适用车型/APPLICATION :**  
2011-2015款 途胜/TUCSON

途胜/TUCSON

2016-2019



OE 25380-D3500

KINFOR NO: CFHY24

OE

KINFOR NO: CFHY24S

OE

KINFOR NO: CFHY24F7

OE

KINFOR NO: CFHY24M

**适用车型/APPLICATION :**  
2016-2019款 途胜/TUCSON

总成/ASSEMBLY

扇框/FAN-SHROUD

扇叶/FAN-BLADE

电机/FAN-MOTOR

## 胜达(水箱)/SANTA FE (RAD FAN) 2001-2005



- OE 25380-26400 KINFOR NO: CFHY17
- OE 25350-26000 KINFOR NO: CFHY17S
- OE 25231-38000 KINFOR NO: CFHY17F7
- OE 25386-26200 KINFOR NO: CFHY17M
- 适用车型/APPLICATION :**  
2001-2005款 胜达(水箱)/SANTA FE (RAD FAN)

## 胜达(冷气)/SANTA FE (COND FAN) 2001-2005



- OE 97730-26150  
97730-26200 KINFOR NO: CFHY21
- OE 97735-26100 KINFOR NO: CFHY21S
- OE 97737-26000 KINFOR NO: CFHY21F7
- OE 97786-26150 KINFOR NO: CFHY21M
- 适用车型/APPLICATION :**  
2001-2005款 胜达(冷气)/SANTA FE (COND FAN)

## 胜达/SANTA FE 2007-2009



- OE 25380-2B100 KINFOR NO: CFHY25
- OE 25350-2B000 KINFOR NO: CFHY25S
- OE 25231-3F000 KINFOR NO: CFHY25F7
- OE 25386-2B100 KINFOR NO: CFHY25M
- 适用车型/APPLICATION :**  
2007-2009款 胜达/SANTA FE

## 胜达/SANTA FE L4 2.0L 2019-2020







- OE 25380-S1000 KINFOR NO: CFHY09
- OE KINFOR NO: CFHY09S
- OE KINFOR NO: CFHY09F9
- OE KINFOR NO: CFHY09M
- 适用车型/APPLICATION :**  
2019-2020款 胜达/SANTA FE L4 2.0L

锐欧(水箱)/RIO (RAD FAN)

2003-2005



-  OE 25380-FD000 KINFOR NO: CFHY12
-  OE 25350-FD100 KINFOR NO: CFHY12S
-  OE 25231-FD100 KINFOR NO: CFHY12F5
-  OE 25386-FD100 KINFOR NO: CFHY12M

 适用车型/APPLICATION :  
2003-2005款 锐欧(水箱)/RIO (RAD FAN)

锐欧(冷气)/RIO (COND FAN)

2003-2005





-  OE 97730-FD000 KINFOR NO: CFHY26
-  OE KINFOR NO: CFHY26S
-  OE KINFOR NO: CFHY26F7
-  OE KINFOR NO: CFHY26M

 适用车型/APPLICATION :  
2003-2005款 锐欧(冷气)/RIO (COND FAN)

赛拉图(水箱)/CERATO (RAD FAN)

2005-2009





-  OE 25380-2F000 KINFOR NO: CFHY27
-  OE 25350-2F000 KINFOR NO: CFHY27S
-  OE 25231-2F000 KINFOR NO: CFHY27F8
-  OE 25386-2F000 KINFOR NO: CFHY27M

 适用车型/APPLICATION :  
2005-2009款 赛拉图(水箱)/CERATO (RAD FAN)

赛拉图(冷气)/CERATO (COND FAN)

2005-2009



-  OE 97730-2F000 KINFOR NO: CFHY22
-  OE 97735-2F000 KINFOR NO: CFHY22S
-  OE 97737-2D500 KINFOR NO: CFHY22F7
-  OE 97786-2F000 KINFOR NO: CFHY22M

 适用车型/APPLICATION :  
2005-2009款 赛拉图(冷气)/CERATO (COND FAN)

 总成/ASSEMBLY

 扇框/FAN-SHROUD

 扇叶/FAN-BLADE

 电机/FAN-MOTOR

领动/ELANTRA

2017-2019



- OE 25380-F2000 KINFOR NO: CFHY03

---

- OE 25350-F2000 KINFOR NO: CFHY03S

---

- OE 25231-F2000 KINFOR NO: CFHY03F7

---

- OE 25386-F2000 KINFOR NO: CFHY03M

适用车型/APPLICATION :  
2017-2019款 领动/ELANTRA

起亚PICANTO (JA)

2017-



- OE 25380-G6050 KINFOR NO: CFHY28

---

- OE 25350-G6000 KINFOR NO: CFHY28S

---

- OE 25231-B4000 KINFOR NO: CFHY28F7

---

- OE 25386-G6050 KINFOR NO: CFHY28M

适用车型/APPLICATION :  
2017款 起亚PICANTO (JA)

电子风扇  
Cooling Fan Assembly

让每个汽配产品都值得信赖

MAKE EVERY AUTO PARTS RELIABLE



# 水箱

OE配套出品

## Radiator Assembly

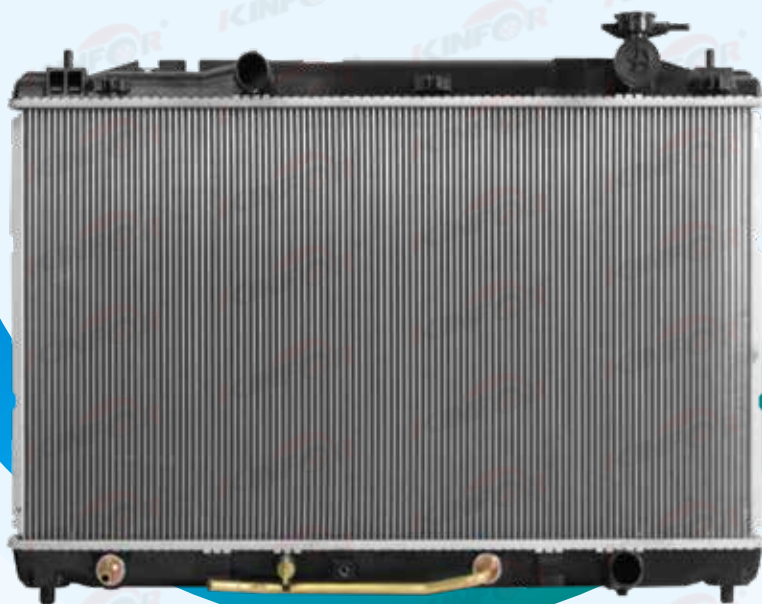

### 金日品质 · 原装同质

KINFOR QUALITY SAME AS PRIGINAL

丰田TOYOTA .....	116-122
本田HONDA .....	123-128
日产NISSAN .....	129-134
马自达MAZDA .....	135-136

# 品质创造价值

# Quality creates profit

适用 **丰田** 系列 FOR TOYOTA SERIES

威驰/VIOS AXP41

16mm-MT  
2003-2005



OE 16400-02420  
16400-02421

KINFOR NO: RAA053-1

威驰/VIOS AXP41

16mm-AT  
2003-2005



OE 16400-02430

KINFOR NO: RAA054-1

威驰/雅力士/VIOS 1.3 水箱

16mm-MT  
2009-2013



OE 16400-0M100

KINFOR NO: RAA002-1

威驰/雅力士/VIOS 1.3 水箱

16mm-AT  
2009-2013



OE 16400-0M110

KINFOR NO: RAA003-1

威驰/雅力士/VIOS 1.6

16mm-MT  
2009-2013



OE 16400-0T060  
16400-0T130

KINFOR NO: RAA011-1

威驰/雅力士/VIOS 1.6

16mm-AT  
2009-2013



OE 16400-0T050  
16400-0T140

KINFOR NO: RAA012-1

威驰/致炫/VIOS NSP15 水箱

16mm-MT  
2013-2016



OE 16400-0Y080

KINFOR NO: RAA034-1

威驰/致炫/VIOS NSP15 水箱

16mm-AT  
2013-2016

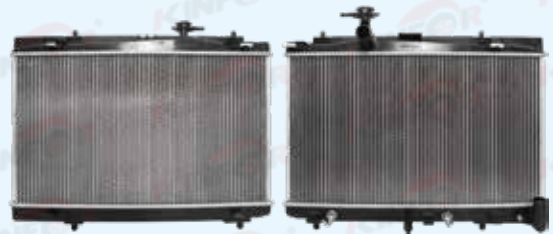

OE 16400-0Y090

KINFOR NO: RAA035-1

水箱 Radiator Assembly

霸道/PRADO 2700

16mm-MT  
2003-2007



OE 16400-75451

KINFOR NO: RAA004-1

霸道/PRADO 2700

16mm-AT  
2003-2007



OE 16400-31351

KINFOR NO: RAA086-1

霸道/PRADO GRJ120 4000  
(26厚)

16mm-MT/AT  
2003-2007



OE 16400-31350/0P160

KINFOR NO: RAA093-2

花冠/COROLLA 1.8 ZZE122

16mm-MT  
2003-2006



OE 16400-0D391  
16400-21140

KINFOR NO: RAA009-1

花冠/COROLLA 1.8 ZZE122

16mm-AT  
2003-2006



OE 16400-21180  
16400-0D381

KINFOR NO: RAA010-1

花冠/COROLLA 1.6 ZRE120

16mm-MT  
2007-2013



OE 16400-0T030

KINFOR NO: RAA015-1

花冠/COROLLA 1.6 ZRE120

16mm-AT  
2007-2013



OE 16400-0T040

KINFOR NO: RAA016-1

卡罗拉/逸致  
/COROLLA ZRE152

16mm-MT  
2008-2018



OE 16400-0T010  
16400-0T340

KINFOR NO: RAA013-1

卡罗拉/逸致  
/COROLLA ZRE152

16mm-AT  
2008-2018



OE 16400-0T020

KINFOR NO: RAA014-1

卡罗拉/COROLLA  
1.2T 17 ZRE181

16mm-MT/AT  
2017



OE 16400-0Y270

KINFOR NO: RAA072-1

卡罗拉/COROLLA 1.2T

16mm-MT/AT  
2019



OE 16400-47130

KINFOR NO: RAA082-1

卡罗拉雷凌 双擎 油电混动  
/COROLLA HYBRID 1.8

16mm-MT/AT  
2019



OE 16400-0T541

KINFOR NO: RAA090-1

卡罗拉 混动  
/COROLLA HYBRID 1.8

16mm-MT/AT  
2018



OE 16400-0T260/0T270

KINFOR NO: RAA095-1

锐志/REIZ GRX122

16mm-MT/AT  
2006-2013



OE 16400-0P100  
16400-0P101

KINFOR NO: RAA042-1

皇冠/CROWN 2.5 (不带管)

16mm-MT/AT  
2015



OE 16400-0P460

KINFOR NO: RAA043-1

皇冠/CROWN GRS182

16mm-MT/AT  
2006-2014



OE 16400-0P090  
16400-0P091

KINFOR NO: RAA044-1



皇冠/CROWN 2.0T (带管)

16mm-MT/AT  
2015



OE 16400-0V250

KINFOR NO: RAA060-1

汉兰达/HIGHLANDER 2.0T  
ASU50

16mm-MT/AT  
2015-2020



OE 16400-0V100

KINFOR NO: RAA055-1

ASU/汉兰达  
/HIGHLANDER 2.7

16mm-AT  
2009-2014



OE 16400-0V040

KINFOR NO: RAA056-1

汉兰达/HIGHLANDER 3.5

16mm-AT  
2009-2014



OE 16400-31480

KINFOR NO: RAA057-1

汉兰达/皇冠 陆放混动  
/HIGHLANDER HYBRID 2.5

16mm-MT/AT  
2021



OE 16400-F0150

KINFOR NO: RAA087-1

汉兰达/HIGHLANDER 3.5

16mm-MT/AT  
2015-2021

OE 16400-0P340

KINFOR NO: RAA058-1

汉兰达 混动  
/HIGHLANDER HYBRID 2.5L

16mm-MT/AT  
2022

OE 16400-F0140

KINFOR NO: RAA092-1

凯美瑞/CAMRY ACV51

16mm-MT/AT  
2012-2017



OE 16400-0V150

KINFOR NO: RAA061-1

凯美瑞/CAMRY ACV51 加密

16mm-MT/AT  
2012-2017



OE 16400-0V150

KINFOR NO: RAA061-C1

凯美瑞  
/CAMRY ACV40 ES240

16mm-MT/AT  
2006-2011



OE 16400-0H290

KINFOR NO: RAA063-1

凯美瑞/CAMRY  
/AXVJR-H71

16mm-MT/AT  
2018



OE 16400-0V300

KINFOR NO: RAA077-1

凯美瑞混动/ 亚洲龙 混动  
/CAMRY HYBRID 2.5

16mm-MT/AT  
2018

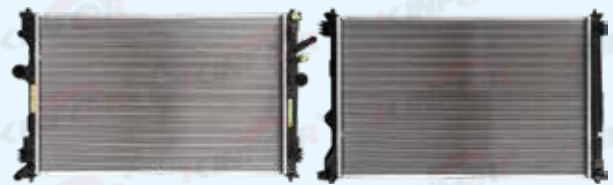

OE 16400-F0030/16400-25140

KINFOR NO: RAA091-1

凯美瑞混动  
/ CAMRY HYBRID 加密

16mm-MT/AT  
2018



OE 16400-F0030/25140

KINFOR NO: RAA091-C1

佳美/CAMRY 2.4 ACV30

16mm-AT  
2003-2005



OE 16400-28280

KINFOR NO: RAA065-1

RAV4 ACA33/ACR50

16mm-MT  
2009-2012

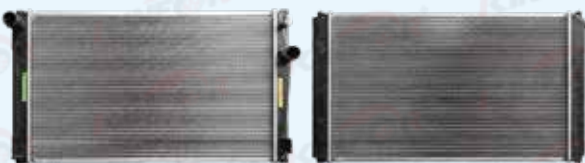

OE 16400-0H360

KINFOR NO: RAA068-1

RAV4 ACA33/ACR50

16mm-AT  
2009-2012



OE 16400-0H350

KINFOR NO: RAA069-1

荣放/ZSA42 2.0

16mm-MT/AT

2015



OE 16400-0V221

KINFOR NO: RAA073-1

奕泽 C-HR/IZOA 2.0

16mm-MT/AT

2018



OE 16400-F2030

KINFOR NO: RAA085-1

雷克萨斯/LEXUS  
ES350 (GSV40)

16mm-MT/AT

2009



OE 16400-31520

KINFOR NO: RAA089-1

雷克萨斯/塞纳/LEXUS  
RX450H/RX350 GYL/GGL

16mm-MT/AT

2011



OE 16041-31620

KINFOR NO: RAA088-1

威尔法 双擎 油电混合  
VELLFIRE HYBRID 2.5

16mm-MT/AT

2020



OE 16400-28711

KINFOR NO: RAA094-1

水箱  
Radiator Assembly



# 水箱 Radiator Assembly

适用 **丰田** 系列  
FOR **TOYOTA** SERIES



水箱 Radiator Assembly

## 适用本田系列 FOR HONDA SERIES

滨智/VEZEL 1.5 RU1 (带管)

16mm-MT/AT  
2015-



OE 19010-50W-H51

KINFOR NO: RAB001-1

滨智/VEZEL 1.8 RU5 (不带管)

16mm-MT/AT  
2015-



OE 19010-51B-H51

KINFOR NO: RAB002-1

锋范/歌瑞/CITY GJ6 (不带管)

16mm-MT  
2015-



OE 19010-55M-H01

KINFOR NO: RAB003-1

锋范/歌瑞/CITY GJ6 (带管)

16mm-AT  
2015-



OE 19010-55M-H51

KINFOR NO: RAB004-1

雅阁/ACCORD 2.3 CG5

16mm-AT  
1998-2003



OE 19010-PAA-A51

KINFOR NO: RAB010-1

雅阁/ACCORD 2.4 CM5

16mm-AT  
2003-2006



OE 19010-PAA-A51

KINFOR NO: RAB011-1

雅阁/ACCORD 2.0/CP1  
2.4/CP2

16mm-AT  
2008-2013



OE 19010-R62-H51  
19010-R40-901

KINFOR NO: RAB013-1

雅阁3.0/歌诗图3.5/ACCORD

16mm-AT  
2008-2013



OE 19010-R76-H51

KINFOR NO: RAB016-1

**雅阁/思铂睿/ACCORD CR1/2**

 16mm-MT/AT  
 2014-2017

OE 19010-5A4-H01

KINFOR NO: RAB017-1

**雅阁/ACCORD /CV1**

 16mm-MT/AT  
 2018

OE 19010-6A0-A01

KINFOR NO: RAB019-1

**雅阁混动  
/ACCORD HYBRID CR6**

 16mm-MT/AT  
 2014-2017

OE 19010-5K0-A01

KINFOR NO: RAB059-1

**思铂睿/SPIRIOR /CU2**

 16mm-AT  
 2011-2015

OE 19010-RL9-H51

KINFOR NO: RAB018-1

**思域/思铭/CIVIC 1.8**

 16mm-MT  
 2006-2011

OE 19010-RNC-T51

KINFOR NO: RAB023-1

**思域/CIVIC /FB2**

 16mm-MT/AT  
 2012-2015

OE 19010-R1A-A52

KINFOR NO: RAB024-1

**思域1.5T/FC1  
/缤智1.5T/CIVIC**

 16mm-MT/AT  
 2016

OE 19010-5AA-A51

KINFOR NO: RAB026-1

**思域/CIVIC FE1/FE3**

 16mm-MT/AT  
 2022

OE 19010-64A-A01

KINFOR NO: RAB065-1

杰德/JADE FR1

16mm-MT  
2013-2017



OE 19010-5M1-H51

KINFOR NO: RAB029-1

飞度两厢/FIT GD1

16mm-MT  
2003-2006



OE 19010-RMN-W01

KINFOR NO: RAB030-1

飞度两厢/FIT GD1

16mm-AT  
2003-2006



OE 19010-RMN-W51

KINFOR NO: RAB031-1

飞度三厢/理念/FIT GD6

16mm-MT  
2006-2008



OE 19010-REJ-W01

KINFOR NO: RAB032-1

飞度三厢/理念/FIT GD6

16mm-AT  
2006-2007



OE 19010-REJ-W51

KINFOR NO: RAB033-1

飞度/FIT GK4 (不带水管)

16mm-MT  
2014-2019



OE 19010-5R3-H02

KINFOR NO: RAB034-1

飞度/FIT GK4 (带管)

16mm-AT  
2014-2019



OE 19010-5R3-H52

KINFOR NO: RAB035-1

飞度/FIT 1.3/1.5

16mm-MT  
2009-2013



OE 19010-RC3-H01

KINFOR NO: RAB036-1

水箱  
Radiator Assembly

**飞度/FIT 1.5L GR9/GS1**
**16mm-MT/AT**  
 2021

OE 19010-6X6-H51

KINFOR NO: RAB064-1

**飞度GE6/锋范/FIT 1.5**
**16mm-AT**  
 2009-2013

OE 19010-RC3-H51

KINFOR NO: RAB037-1

**锋范/凌派/CITY 1.8 GM3**
**16mm-MT/AT**  
 2009-2014

OE 19010-RR2-H01

KINFOR NO: RAB038-1

**奥德赛/ODYSSEY RA6**
**16mm-MT/AT**  
 2002-2004

OE 19010-PGM-902

KINFOR NO: RAB040-1

**奥德赛/ODYSSEY RB1**
**16mm-AT**  
 2005-2008

OE 19010-RFE-W01

KINFOR NO: RAB041-1

**奥德赛/ODYSSEY RB1 (加密)**
**16mm-AT**  
 2005-2008

OE 19010-RFE-W01

KINFOR NO: RAB041-C1

**奥德赛/ODYSSEY RB3**
**16mm-AT**  
 2009-2013

OE 19010-RLF-901

KINFOR NO: RAB042-1

**奥德赛/ODYSSEY RC3/RR8**
**16mm-MT/AT**  
 2014

OE 19010-5X6-J01

KINFOR NO: RAB044-1



奥德赛/ODYSSEY RC4

16mm-MT/AT  
2019



OE 19010-6W0-H01

KINFOR NO: RAB063-1

CRV RD5

16mm-AT  
2007-2011

OE 19010-PPA-A51

KINFOR NO: RAB047-1

CRV 2.0 RE2

16mm-AT  
2007-2011



OE 19010-RZP-G51

KINFOR NO: RAB049-1

CRV 2.0 RE2 (加密)

16mm-AT  
2007-2011



OE 19010-RZP-G51

KINFOR NO: RAB049-C1

CRV 2.4 RE4

16mm-AT  
2007-2011



OE 19010-RZA-A51

KINFOR NO: RAB050-1

CRV RM4

16mm-MT/AT  
2012-2016



OE 19010-R5A-A51

KINFOR NO: RAB051-1

CRV

16mm-MT/AT  
2017



OE 19010-5PA-A01

KINFOR NO: RAB056-1

CR-V/皓影 混动 2.0 RT5

16mm-MT/AT  
2020

OE 19010-5TZ-H01

KINFOR NO: RAB067-1

**艾力绅/ELYSION RR7**

 16mm-AT  
 2006-2014

OE 19010-R28-H51

KINFOR NO: RAB054-1

**冠道/AVANCIER 1.5T  
TG1 (带管)**

 16mm-MT/AT  
 2017

OE 19010-5MY-H01

KINFOR NO: RAB057-1

**冠道/AVANCIER 2.0  
TG2 (不带管)**

 16mm-MT/AT  
 2017

OE 19010-5MS-H01

KINFOR NO: RAB058-1

**凌派/CRIDER 1.0T FS1**

 16mm-AT  
 2019

OE 19010-6P7-H01

KINFOR NO: RAB062-1

**凌派1.5L混动/享域FS2  
/FS5 HYBRID CRIDER**

 16mm-MT/AT  
 2020

OE 19010-6T9-H01

KINFOR NO: RAB068-1

**歌诗图/CROSSTOUR  
GST 2.4 TF3**

 16mm-MT/AT  
 2011

OE 19010-5L7-H61

KINFOR NO: RAB014-1

# 适用日产系列 FOR NISSAN SERIES

颐达/骐达/轩逸/骊威/俊逸  
/TIIDA/SYLPHY 1.8

16mm-AT  
2005-2010



OE 21460-ED500

KINFOR NO: RAC001-1

颐达/骐达/轩逸  
/TIIDA/SYLPHY

16mm-MT  
2005-2010



OE 21410-ED500

KINFOR NO: RAC002-1

骐达/TIIDA 1.6T

16mm-MT/AT  
2011-2014



OE 21410-1KC5A

KINFOR NO: RAC003-1

蓝鸟/风神/BLUE BIRD U13

16mm-AT  
2005



OE 21460-1E000

KINFOR NO: RAC004-1

天籁/ALTIMA 2.0 J31

16mm-AT  
2003-2007



OE 21460-9W210

KINFOR NO: RAC005-1

天籁/ALTIMA 2.3/2.5 J31

16mm-AT  
2004-2007



OE 21460-9W200

KINFOR NO: RAC006-1

天籁/ALTIMA J32

16mm-AT  
2008-2012



OE 21460-JN00A

KINFOR NO: RAC008-1

天籁/ALTIMA L33

16mm-MT/AT  
2013-2018

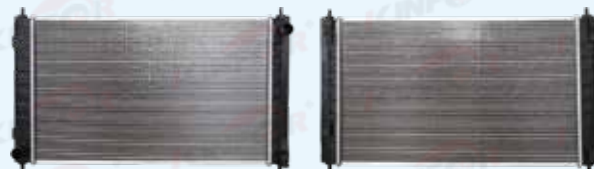

OE 21410-3TS0A

KINFOR NO: RAC009-1

**天籁/ALTIMA**

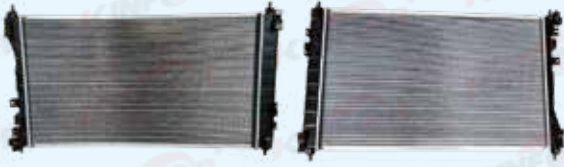
 16mm-MT  
 2019

OE 21410-6CT0B

KINFOR NO: RAC059-1

**启辰 电动/VELOCIA D60 EV**

 16mm-MT/AT  
 2019

OE 21410-2GR0A

KINFOR NO: RAC068-1

**启辰 自动/手动/VELOCIA  
T90 2.0 (不带小水管)**

 16mm-MT/AT  
 2016

OE 21410-2GD0A

KINFOR NO: RAC064-1

**N16/阳光/SUNNY 2.0**

 16mm-AT  
 2003-2006

OE 21460-7N900 /6M200

KINFOR NO: RAC010-1

**阳光/N17玛驰 /SUNNY**

 16mm-MT  
 2010-2013

 OE 21410-3AA2A  
 21460-1HS2A

KINFOR NO: RAC030-1

**帅客1.5/御轩2.0 CDV**

 16mm-MT  
 2009

OE 21410-2ZS9B

KINFOR NO: RAC012-1

**帅客/CDV 1.6**

 16mm-MT  
 2009

OE 21410-2ZS00

KINFOR NO: RAC013-1

**皮卡ZD25/Y37/锐琪2.4**

 16mm-MT  
 2013

OE 21410-Y3700

KINFOR NO: RAC014-1

皮卡P31

16mm-MT

/

OE 21410-P3100

KINFOR NO: RAC016-1

皮卡P27/ZG24/锐琪3.0

16mm-MT

/

OE 21410-P2700

KINFOR NO: RAC032-1



皮卡D22/帕拉丁

16mm-MT

/

OE 21410-71A00

KINFOR NO: RAC023-1



逍客/QASHQAI 1.6

26mm-MT/AT

2007-2014

OE 21400-JD900

KINFOR NO: RAC020-2



逍客/QASHQAI J10 2.0

26mm-MT/AT

2007-2014

OE 21400-JE20A

KINFOR NO: RAC021-2



逍客/QASHQAI (不带管)

26mm-MT/AT

2007-2014

OE 21410-JE30B

KINFOR NO: RAC022-2



逍客/QASHQAI 1.2T  
(不带管)

16mm-MT/AT

2015

OE 21410-DF30A

KINFOR NO: RAC047-1



逍客/QASHQAI 2.0 (带管)

16mm-MT/AT

2015

OE 21410-DF40A

KINFOR NO: RAC048-1

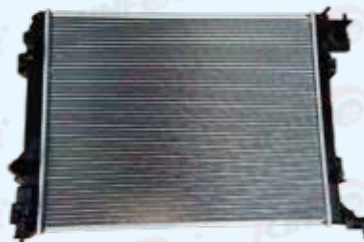

**逍客/QASHQAI J10 通装版**
**16mm-MT/AT**  
 2008

OE

KINFOR NO: RAC064-1

**奇骏/ROGUE 2.0/2.5 T31**
**16mm-MT**  
 2008-2013

 OE 21400-JG000  
 21400-1DAOA

KINFOR NO: RAC031-1

**奇骏/ROGUE 2.5 T32**
**16mm-AT**  
 2014-2018

OE 21460-4CL0A

KINFOR NO: RAC038-1

**奇骏/ROGUE 2.0 T32**
**16mm-MT**  
 2014-2018

OE 21410-4CL0A

KINFOR NO: RAC039-1

**奇骏/ROGUE T33 2.5**
**16mm-MT/AT**  
 2019

OE 21460-6RC0A

KINFOR NO: RAC069-1

**轩逸 蓝鸟/SYLPHY B17/15**
**16mm-MT/AT**  
 2012-2018

OE 21410-3RA0A

KINFOR NO: RAC035-1

**轩逸/SYLPHY B18**
**16mm-MT/AT**  
 2019

OE 21410-6LA0D

KINFOR NO: RAC062-1

**轩逸 纯电动/SYLPHY**
**16mm-MT/AT**  
 2019

OE 21410-5UROA-YL

KINFOR NO: RAC067-1

水箱 Radiator Assembly

NV200 MT

16mm-MT  
2010-2018



OE 21410-JX00A  
21410-JX30A

KINFOR NO: RAC036-1

风度/CEFIRO A33

16mm-MT/AT  
2004-2006



OE 21460-2Y603

KINFOR NO: RAC041-1

ZD22/奥丁/OTING 2.5T

16mm-MT/AT  
2013

OE 21400-2ZW2A

KINFOR NO: RAC043-1

ZD25

16mm-MT  
2019

OE 21400-2ZW0B

KINFOR NO: RAC045-1

T70 1.6/2.0  
VENUCIA T70

16mm-MT  
/

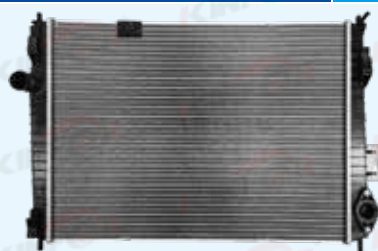

OE 21410-2FL0A

KINFOR NO: RAC054-1

骊威/LIVINA

16mm-MT/AT  
2005-2010

OE 21460-CJ00A

KINFOR NO: RAC063-1

楼兰/贵士/MURANO 3.5

16mm-MT/AT  
2008-2014

OE 21460-1AA0A

KINFOR NO: RAC049-1

楼兰/MURANO

16mm-MT/AT  
2015

OE 21460-5BC1A

KINFOR NO: RAC050-1

途乐/PATROL Y62

32mm-MT/AT  
2010-2014

途乐/PATROL Y61 TB45

26mm-MT/AT  
2000-2009

OE 21460-5ZU0A

KINFOR NO: RAC068-32

OE 21460-VB000

KINFOR NO: RAC055-2

劲客/KICKS 1.5L

16mm-MT/AT  
2017

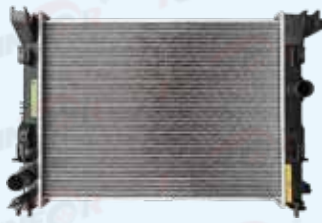

OE 21410-5RF0B

KINFOR NO: RAC034-1



# 适用马自达系列 FOR MAZDA SERIES

马自达6/MAZDA 6

16mm-MT/AT  
2003-2005



OE L328-15-200-A

KINFOR NO: RAE001-1

马自达6/MAZDA 6 B70

16mm-AT  
2005-2013



OE L31W-15-200-A

KINFOR NO: RAE002-1

马自达6/MAZDA 6 B70

16mm-MT  
2005-2013



OE L31W-15-200-A

KINFOR NO: RAE003-1

奔腾/BESTURN B50

16mm-MT/AT  
2013-2014



OE FA01-15200P1

KINFOR NO: RAE009-1

奔腾/BESTURN B50F

16mm-MT/AT  
2014-2015



OE 5BA0-15200

KINFOR NO: RAE036-1

马自达/MAZDA CX-7

16mm-AT  
2015



OE L33L-15-200  
L555-15-200

KINFOR NO: RAE006-1

马自达/MAZDA CX-4

16mm-MT/AT  
2016



OE PEJC-15200

KINFOR NO: RAE035-1

马自达/MAZDA CX-5

16mm-MT  
/

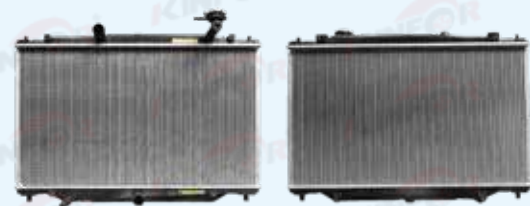

OE PE01-15-200B

KINFOR NO: RAE005-1

长安M2/嘉年华  
/CHANA M2/FIESTA

16mm-MT  
2008



OE ZJ36-15-200BA

KINFOR NO: RAE031-1

长安M3/福克斯

16mm-MT/AT  
/

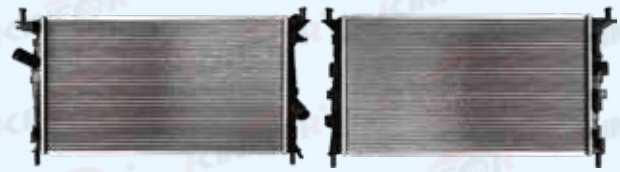

OE L33X-15-200A

KINFOR NO: RAE007-1

长安M2/嘉年华  
/CHANA M2/FIESTA

16mm-AT  
2009

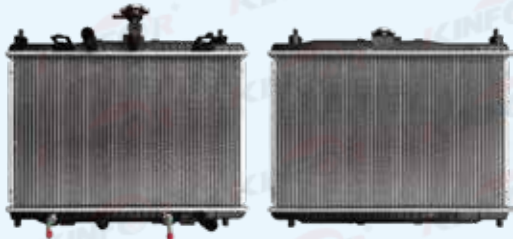

OE Z657-15-200B

KINFOR NO: RAE030-1

让每个汽配产品都值得信赖

MAKE EVERY AUTO PARTS RELIABLE



冷凝器

OE配套出品

Condenser Assembly



冷凝器  
Condenser Assembly

CONDENSER  
ASSEMBLY

金日品质 · 原装同质

KINFOR QUALITY SAME AS ORIGINAL

丰田TOYOTA	138-141
本田HONDA	143-147
日产NISSAN	149-151
马自达MAZDA	152

# 适用丰田系列 FOR TOYOTA SERIES

凯美瑞/CAMRY ACV40

2006-2011

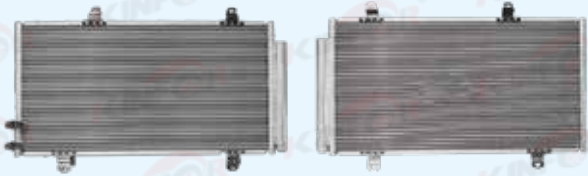

OE 88460-06220

KINFOR NO. JR-LNQ-T017

凯美瑞 混动/CAMRY HYBRID

2007-2011

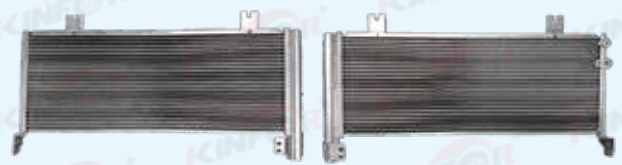

OE 88460-33120

KINFOR NO. JR-LNQ-T075

凯美瑞 混动  
/CAMRY HYBRID ES300H

2012

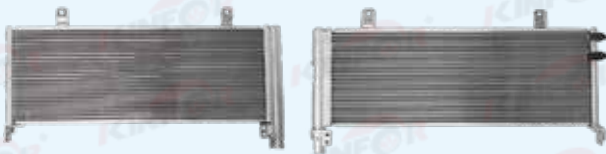

OE 88460-33130

KINFOR NO. JR-LNQ-T057

凯美瑞/CAMRY ACV51  
2013-2014 雷克萨斯/LEXUS ES250

2012-2017



OE 88460-06250/33170

KINFOR NO. JR-LNQ-T033

凯美瑞/CAMRY  
雷克萨斯/LEXUS ES200

2018

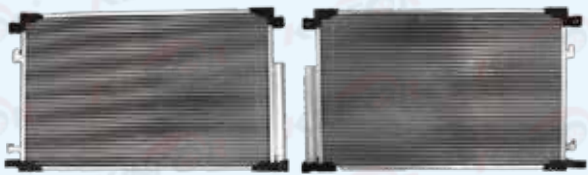

OE 884A0-06060/33040

KINFOR NO. JR-LNQ-T063

卡罗拉/COROLLA ZRE152

2008-2015



OE 88450-02460/02320/02440

KINFOR NO. JR-LNQ-T021

卡罗拉 混动  
/COROLLA HYBRID 1.8

2016

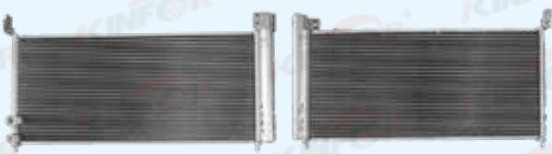

OE 88450-02490/02500

KINFOR NO. JR-LNQ-T059

卡罗拉/COROLLA 1.2T

2016



OE 88450-02540  
88450-02550

KINFOR NO. JR-LNQ-T065

卡罗拉/COROLLA

2019



OE 884A0-02240

KINFOR NO: JR-LNQ-T073

皇冠/CROWN GRS182

2006-2014

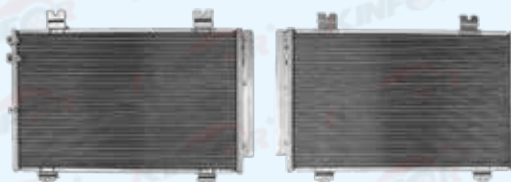

OE 88460-0N010

KINFOR NO: JR-LNQ-T027

皇冠/CROWN 2.5

2015-2019



OE 88460-0N040

KINFOR NO: JR-LNQ-T077

皇冠/CROWN 2.0T

2015-2019



OE 88460-0N050

KINFOR NO: JR-LNQ-T061

花冠/COROLLA ZZE122 F3

2003-2006



OE 88450-02270

KINFOR NO: JR-LNQ-T007

花冠/COROLLA ZRE120

2007-2013

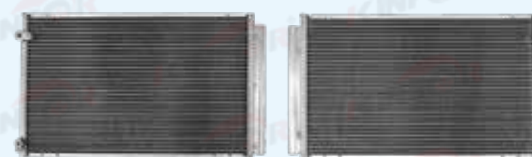

OE 88450-02340

KINFOR NO: JR-LNQ-T019

汉兰达/HIGHLANDER  
CSU4# 2.7 /3.5

2009-2014



OE 88460-48100/0E040

KINFOR NO: JR-LNQ-T023

汉兰达/HIGHLANDER

2015-2020



OE 88460-0E100

KINFOR NO: JR-LNQ-T055

汉兰达 双擎/皇冠陆放 混动  
/HIGHLANDER HYBRID 2.5

2021

OE 884A0-0E070

KINFOR NO: JR-LNQ-T076

霸道/PRADO  
4000 GRJ120 (单空调)

2003-2009

OE 88461-60091

KINFOR NO: JR-LNQ-T029



霸道/PRADO  
2700 RZJ120 (双空调)

2003-2009

OE 88461-60100

KINFOR NO: JR-LNQ-T035



普拉多/PRADO GRJ150

2009-2015

OE 88460-60430

KINFOR NO: JR-LNQ-T074



RAV4 ACA33/ACR50

2008-2012

OE 88460-0R020

KINFOR NO: JR-LNQ-T025

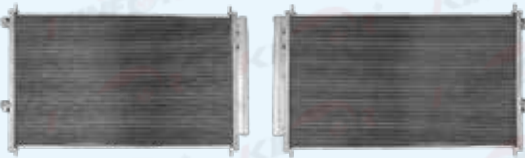

RAV4

2013-2019

OE 88460-0R050

KINFOR NO: JR-LNQ-T045



奕泽/C-HR/IZOA

2018

OE 884A0-F4020

KINFOR NO: JR-LNQ-T071



威驰/金刚/新款/VIOS

2004-2005

OE 88450-0D130

KINFOR NO: JR-LNQ-T005



冷凝器  
Condenser Assembly

威驰/VIOS

2006-2007



OE 88450-0D150

KINFOR NO: JR-LNQ-T009

雅力士/威驰/YARIS/VIOS 1.6

2008-2013



OE 88460-0D120

KINFOR NO: JR-LNQ-T013

雅力士/威驰/YARIS/VIOS 1.3

2008-2013



OE 88460-0D140

KINFOR NO: JR-LNQ-T011

威驰/VIOS

2014



OE 88460-0D230

KINFOR NO: JR-LNQ-T051

锐志/REIZ GRX122

2006-2014



OE 88460-0P020

KINFOR NO: JR-LNQ-T015

雷克萨斯/LEXUS  
RX270/RX350

2011

OE 88460-48140  
88460-08020

KINFOR NO: JR-LNQ-T078

雷克萨斯/LEXUS  
GS350/GS250

2011

OE 88460-30B40

KINFOR NO: JR-LNQ-T079





## 适用本田系列 FOR HONDA SERIES

雅阁/ACCORD CM5/CM6

2003-2007



OE 80110-SDG-W01

KINFOR NO. JR-LNQ-H005

雅阁/歌诗图/ACCORD  
CP1/CP2

2008-2013

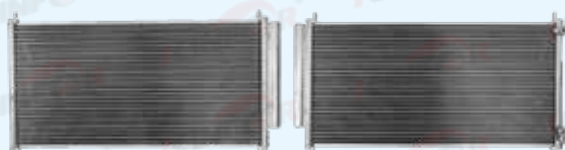

OE 80110-TB0-003

KINFOR NO. JR-LNQ-H019

雅阁 混动  
/ACCORD HYBRID CR6

2014

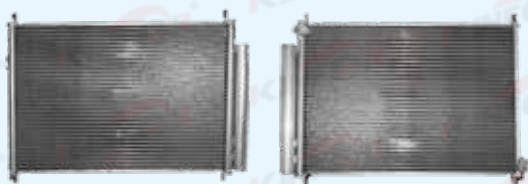

OE 80110-T3V-A01

KINFOR NO. JR-LNQ-H074

雅阁/ACCORD CR1/2

2014-2017

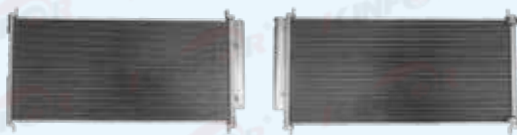

OE 80110-T2J-H01

KINFOR NO. JR-LNQ-H049

雅阁/ACCORD CV1

2018



OE 80100-TVA-A01

KINFOR NO. JR-LNQ-H076

思域/CIVIC FA1

2006-2011



OE 80110-SNN-A44

KINFOR NO. JR-LNQ-H017

思域/CIVIC FB2

2012-2015

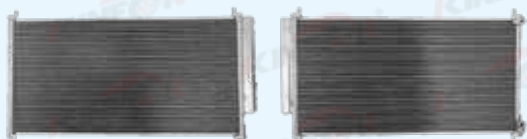

OE 80110-TS6-H01

KINFOR NO. JR-LNQ-H037

思域/CIVIC FC1

2016-2020

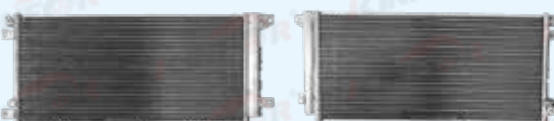

OE 80110-TET-H01

KINFOR NO. JR-LNQ-H065

思域/CIVIC

2022

思铂睿/SPIRIOR CU2

2009-2015

OE 80100-T31-H01

KINFOR NO. JR-LNQ-H080

OE 80110-TP5-H01

KINFOR NO. JR-LNQ-H033



凌派/CRIDER 1.8 GJ5

2013-2018

凌派/CRIDER

2019

OE 80110-T6P-H01

KINFOR NO. JR-LNQ-H045

OE 80100-TBT-H01

KINFOR NO. JR-LNQ-H078

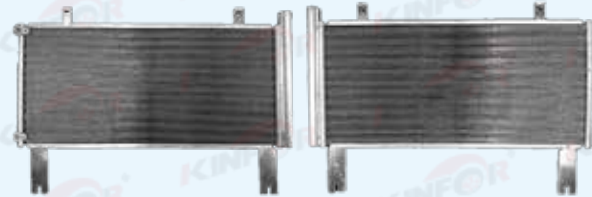
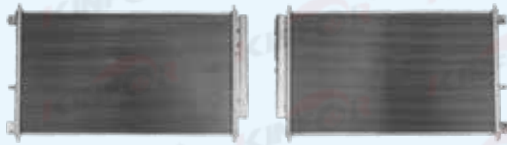

凌派 混动  
/CRIDER HYBRID 1.5

2020

理念/EVERUS G11

2009-2012

OE 80100-TJH-H01

KINFOR NO. JR-LNQ-H081

OE 80110-S0L-H01

KINFOR NO. JR-LNQ-H041



理念/EVERUS

2012-2014

杰德/JADE 1.8

2013-2017

OE 80110-SOL-H11

KINFOR NO. JR-LNQ-H059

OE 80110-T4N-H01

KINFOR NO. JR-LNQ-H047

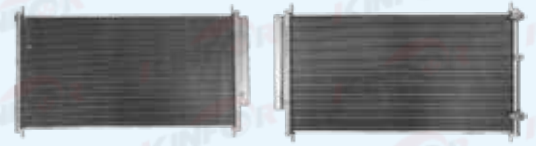
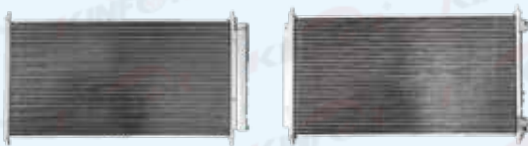

杰德/JADE FR2

2018



OE 80110-T4D-H01

KINFOR NO: JR-LNQ-H072

冠道/AVANCIER 2.0

2017

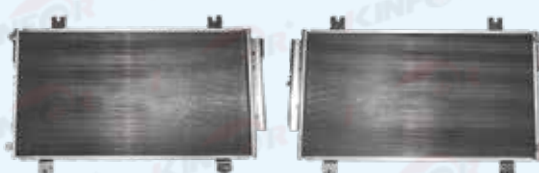

OE 80110-THA-H01

KINFOR NO: JR-LNQ-H067

锋范/CITY GM2/GM3

2009-2014



OE 80110-TM5-H01

KINFOR NO: JR-LNQ-H021

锋范/歌瑞/CITY

2015



OE 80110-T9A-T01

KINFOR NO: JR-LNQ-H061

飞度两厢/FIT GD1

2003-2005

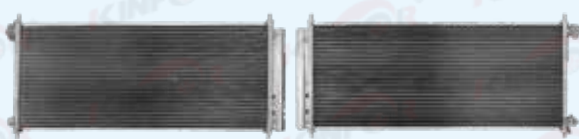

OE 80110-SAA-013

KINFOR NO: JR-LNQ-H007

飞度三厢/FIT GD6

2006-2008

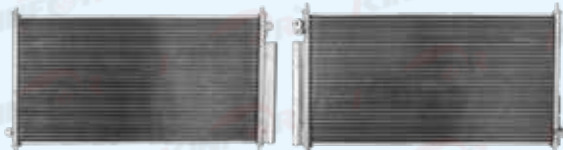

OE 80110-SEM-M02

KINFOR NO: JR-LNQ-H009

飞度/FIT GE6

2009-2013

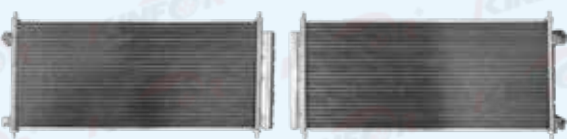

OE 80110-TF0-G02

KINFOR NO: JR-LNQ-H029

奥德赛/ODYSSEY RC3

2014-2019

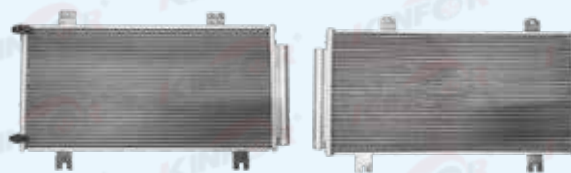

OE 80110-T5L-T01

KINFOR NO: JR-LNQ-H057

飞度/FIT 1.5L GR9/GS1

2021

OE 80100-T04-M01

KINFOR NO: JR-LNQ-H079

滨智/RU/XR-V 1.5/1.8

2013-2020

OE 80110-T7A-J01

KINFOR NO: JR-LNQ-H053

奥德赛/ODYSSEY RA6

2002-2005

OE 80110-SCP-W01

KINFOR NO: JR-LNQ-H003

奥德赛/ODYSSEY RB1

2006-2008

OE 80110-SFJ-W01

KINFOR NO: JR-LNQ-H001

奥德赛/ODYSSEY RB3

2009-2013

OE 80110-SFE-003

KINFOR NO: JR-LNQ-H015

奥德赛/ODYSSEY RC3

2014

OE 80110-T6A-003

KINFOR NO: JR-LNQ-H055

CRV RD5

2003-2006

OE 80110-S9A-013

KINFOR NO: JR-LNQ-H011

CRV RE2/RE4

2007-2011

OE 80110-SWN-W01

KINFOR NO: JR-LNQ-H027

冷凝器  
Condenser Assembly

CRV RM4

2012-2016

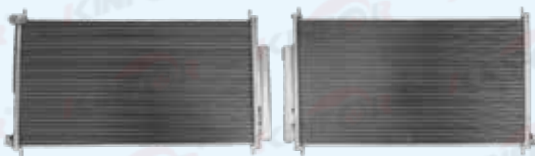

OE 80110-T0T-H01

KINFOR NO: JR-LNQ-H035

CRV RW1/2

2017

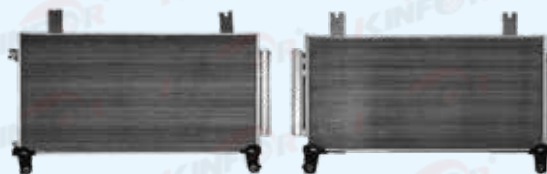

OE 80100-TLA-A01

KINFOR NO: JR-LNQ-H070

艾力绅/ELYSION

2013-2015



OE 80110-SJK-003

KINFOR NO: JR-LNQ-H051

冷凝器  
Condenser Assembly



## 适用日产系列 FOR NISSAN SERIES

阳光/SUNNY N16

2003-2009

OE 92100-7N900

KINFOR NO. JR-LNQ-N062

阳光/玛驰/SUNNY N17

2010-2013

OE 92100-1HS2A

KINFOR NO. JR-LNQ-N031

轩逸/SYLPHY B17

2006-2011

OE 92100-3RA0A/5MA0A

KINFOR NO. JR-LNQ-N046

轩逸电动/SYLPHY

2018

OE 92100-3NL1A

KINFOR NO. JR-LNQ-N59

劲客/轩逸/SYLPHY

2019

OE 92100-5RFOA

KINFOR NO. JR-LNQ-N054

颐达/骐达/轩逸/启辰  
/TIIDA/SYLPHY/VENUCIA

2006-2011

OE 92100-ED500

KINFOR NO. JR-LNQ-N003

骐达/TIIDA/1.6T

2013

OE 92100-3DD0A

KINFOR NO. JR-LNQ-N048

奇骏/ROGUE T31

2008-2013

OE 92100-1DA0A/JG000

KINFOR NO. JR-LNQ-N033

冷凝器  
Condenser Assembly

奇骏/ROGUE T32

2014-2019

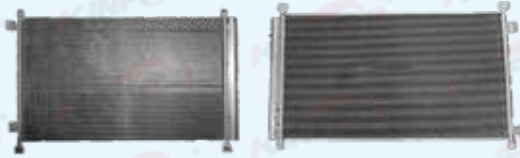

OE 92100-4CL0A

KINFOR NO: JR-LNQ-N052

逍客/QASHQAI J10

2007-2014

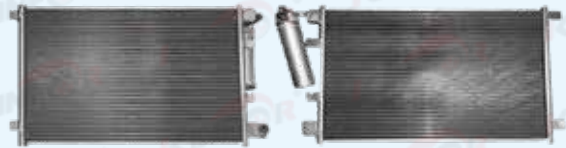

OE 92100-JE30A

KINFOR NO: JR-LNQ-N025

逍客/QASHQAI

2015-2018



OE 92100-DF30A

KINFOR NO: JR-LNQ-N035

天籁/ALTIMA J31

2004-2007

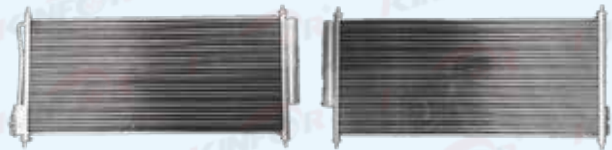

OE 92110-CA000

KINFOR NO: JR-LNQ-N009

天籁/ALTIMA J32

2008-2012

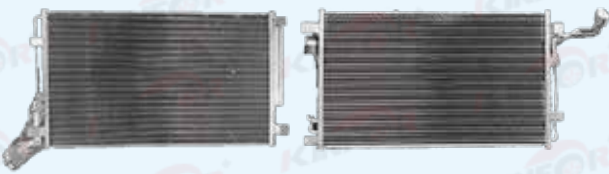

OE 92100-JN20A

KINFOR NO: JR-LNQ-N019

天籁/ALTIMA L34

2019



OE 92100-6CT0A

KINFOR NO: JR-LNQ-N058

启辰/VENUCIA T70/T90

2017-2019

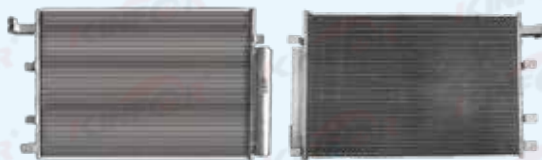

OE 92100-2FL1A  
92100-2FL0B

KINFOR NO: JR-LNQ-N039

楼兰/贵士/MURANO 3.5

2008-2014

OE 92100-1AA0A

KINFOR NO: JR-LNQ-N061

冷凝器  
Condenser Assembly



楼兰/MURANO

2015

蓝鸟/风神  
/U13/大口/BLUE BIRD

2006-2011

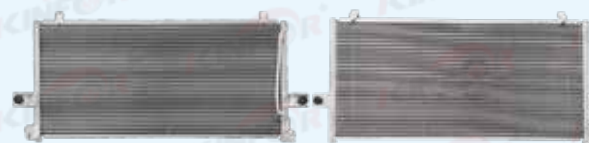

OE 92100-5BC0A-B010

KINFOR NO: JR-LNQ-N060

OE 92111-3E601

KINFOR NO: JR-LNQ-N007

蓝鸟/风神  
/U13/大口/BLUE BIRD

2006-2011



OE 92111-5E900

KINFOR NO: JR-LNQ-N005

# 适用马自达系列 FOR MAZDA SERIES

一汽/M6/奔腾/MAZDA 6

2006-2012



OE GJ6A-64-480BL2

KINFOR NO. JR-LNQ-M005

睿翼/MAZDA 6

2010



OE GV7D-61-480A

KINFOR NO. JR-LNQ-M008

让每个汽配产品都值得信赖

MAKE EVERY AUTO PARTS RELIABLE



# 中冷器

OE配套出品

## Intercooler Assembly



金日品质 · 原装同质

KINFOR QUALITY SAME AS PRIGINAL

# INTERCOOLER ASSEMBLY

中冷器  
Intercooler Assembly

丰田TOYOTA .....	154
本田HONDA .....	155
日产NISSAN .....	156

# 适用丰田系列 FOR TOYOTA SERIES

卡罗拉/雷凌/COROLLA 1.2T

2016-2018

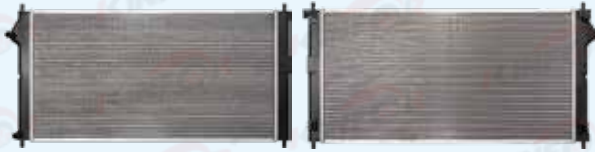

OE 16550-0Y060

KINFOR NO. JR-ZLT001

汉兰达/HIGHLANDER 2.0T

2015



OE 16550-0V010

KINFOR NO. JR-ZLT002

卡罗拉/雷凌/COROLLA 1.2T

2019



OE 16550-0Y110

KINFOR NO. JR-ZLT003

雷克萨斯/LEXUS  
NX200T AGZ10

2015



OE 16550-36011

KINFOR NO. JR-ZLT005

皇冠/CROWN 2.0T

2015-2017



OE 16550-0V020

KINFOR NO. JR-ZLT004

雷克萨斯/LEXUS  
IS200T 2.0T

2016



OE 16550-36030

KINFOR NO. JR-ZLT006

雷克萨斯/LEXUS  
RX200/300 2.0T

2016



OE 16550-36020

KINFOR NO. JR-ZLT007

卡罗拉/雷凌 混动  
/COROLLA HYBRID

2015-2017



OE G9010-12010

KINFOR NO. JR-ZLT008

## 适用本田系列 FOR HONDA SERIES

思域/CIVIC 1.5T

2016-2021



OE 19710-5AA-A01

KINFOR NO. JR-ZLH001

思域/CIVIC 1.5T

2022



OE 19710-64A-A01

KINFOR NO. JR-ZLH009

杰德/JADE 1.5T

2017-2019



OE 19710-5ZX-H01

KINFOR NO. JR-ZLH002

缤智/VEZEL XRV 1.5T

2019



OE 19710-6N0-006

KINFOR NO. JR-ZLH003

冠道/AVANCIER URV 1.5T

2017

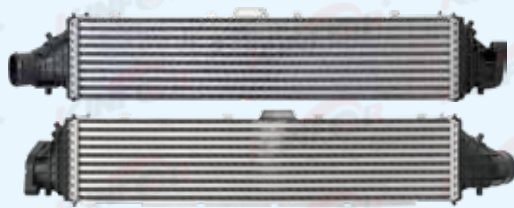

OE 19710-5MY-H01

KINFOR NO. JR-ZLH004

冠道/AVANCIER URV 2.0T

2017

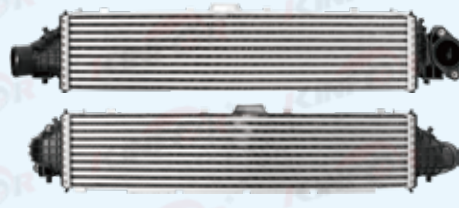

OE 19710-5MS-H01

KINFOR NO. JR-ZLH005

CRV 1.5T

2017



OE 19710-5PA-A01

KINFOR NO. JR-ZLH006

凌派/享誉/CRIDER 1.0T

2019



OE 19710-6P7-H01

KINFOR NO. JR-ZLH007

10代雅阁  
/10TH GEN ACCORD 1.5T

2018



OE 19710-6A0-A01

KINFOR NO. JR-ZLH008

## 适用日产系列 FOR NISSAN SERIES

天籁/ALTIMA

2019



OE 14461-6CB0A

KINFOR NO. JR-ZLN001

让每个汽配产品都值得信赖

MAKE EVERY AUTO PARTS RELIABLE



# 鼓风机

OE配套出品

## Heater NISSAN Blower Motor



金日品质 · 原装同质

KINFOR QUALITY SAME AS PRIGINAL

丰田TOYOTA ..... 158-161

本田HONDA ..... 162-166

日产NISSAN ..... 167-170

## 适用丰田系列 FOR TOYOTA SERIES

KINFOR NO: **JR-BLT001**



**OE** 87103-02180/02700

转向/ROTATION: **逆时针 CCW**

**适用车型/APPLICATION :**

**FOR TOYOTA**  
2008-2019 卡罗拉/COROLLA  
2008-2019 RAV4  
2014-2018 雷凌/LEVIN (双插)

KINFOR NO: **JR-BLT002**



**OE** 87103-02190/0R020

转向/ROTATION: **逆时针 CCW**

**适用车型/APPLICATION :**

**FOR TOYOTA**  
2008-2019 卡罗拉/COROLLA  
2008-2019 RAV4  
2014-2018 雷凌/LEVIN (三插)

KINFOR NO: **JR-BLT003**



**OE** 87103-06090/0E070

转向/ROTATION: **逆时针 CCW**

**适用车型/APPLICATION :**

**FOR TOYOTA**  
2006-2017 凯美瑞/CAMRY  
2009-2020 汉兰达/HIGHLANDER  
2010-2019 霸道/PRADO 150  
2009-2021 4RUNNER  
**FOR LEXUS**  
2009-2021 雷克萨斯/LEXUS GX460

KINFOR NO: **JR-BLT004**



**OE** 87103-60330/60360

转向/ROTATION: **逆时针 CCW**

**适用车型/APPLICATION :**

**FOR TOYOTA**  
2007-2009 霸道/PRADO 120  
**FOR LEXUS**  
2007-2009 雷克萨斯/LEXUS GX470



KINFOR NO: **JR-BLT005**



**OE** 87103-35040/3505/35060/35080

转向/ROTATION: **逆时针 CCW**

**适用车型/APPLICATION :**

**FOR TOYOTA**  
2003-2006 霸道/PRADO 120  
2002-2005 4RUNNER

**FOR LEXUS**  
2003-2006 雷克萨斯/LEXUS GX470

KINFOR NO: **JR-BLT006**



**OE** 87103-33081/33071

转向/ROTATION: **逆时针 CCW**

**适用车型/APPLICATION :**

**FOR TOYOTA**  
2002-2005 佳美/CAMRY 2.4

**FOR LEXUS**  
2001-2005 雷克萨斯 ES系列/LEXUS ES SERIES

KINFOR NO: **JR-BLT007**



**OE** 87103-0N010/0N011/60390/60480/60481  
/60560/30450/30451/48080/50100

转向/ROTATION: **逆时针 CCW**

**适用车型/APPLICATION :**

**FOR TOYOTA**  
2006- 皇冠/CROWN  
2006-2013 锐志/REIZ/MARK-X  
2007-2019 陆巡/LANG CRUISER 200

**FOR LEXUS**  
2007-2015 雷克萨斯 LX系列/LEXUS LX SERIES  
2006-2015 雷克萨斯 IS/GS系列/LEXUS IS/GS SERIES  
2008-2015 雷克萨斯 RX系列/LEXUS RX SERIES  
2006-2012 雷克萨斯 ES系列/LEXUS RS SERIES  
2006-2010 雷克萨斯 LS系列/LEXUS LS SERIES  
2011-2021 雷克萨斯 CT系列/LEXUS CT SERIES

KINFOR NO: **JR-BLT008**



**OE** 87103-12070/02070/02050/02370

转向/ROTATION: **逆时针 CCW**

**适用车型/APPLICATION :**

**FOR TOYOTA**  
2003-2006 花冠/COROLLA  
2003-2008 AVENSIS  
2003-2006 美版卡罗拉/COROLLA USA MODEL  
2003-2007 美版MATRIX/MATRIX USA MODEL

KINFOR NO: **JR-BLT009**



**OE** 87103-02220/02221/02500

转向/ROTATION: **逆时针 CCW**

**适用车型/APPLICATION:**  
FOR TOYOTA  
2007-2013 花冠EX/COROLLA

KINFOR NO: **JR-BLT010**

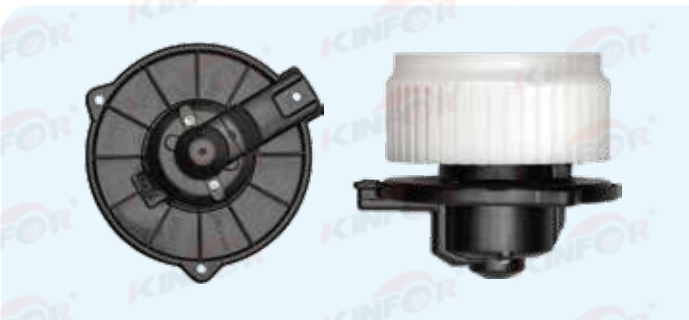

**OE** 87103-0D040

转向/ROTATION: **逆时针 CCW**

**适用车型/APPLICATION:**  
FOR TOYOTA  
2003-2007 威驰/VIOS

KINFOR NO: **JR-BLT011**

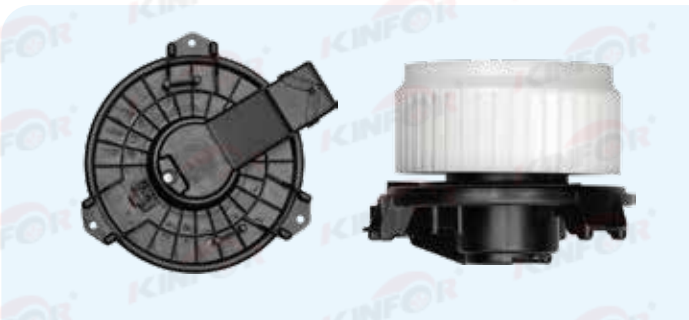

**OE** 87103-0D100/0D170/52141/52140

转向/ROTATION: **逆时针 CCW**

**适用车型/APPLICATION:**  
FOR TOYOTA  
2008-2013 威驰/VIOS  
2009-2013 雅力士/YARIS

KINFOR NO: **JR-BLT012**



**OE** 87103-0D270/0D340

转向/ROTATION: **逆时针 CCW**

**适用车型/APPLICATION:**  
FOR TOYOTA  
2014-2021 威驰/VIOS  
2014-2021 雅力士致炫/YARIS L

KINFOR NO: **JR-BLT013**

**OE** 87103-F4060/02650

转向/ROTATION: **逆时针 CCW**

**适用车型/APPLICATION :**

FOR TOYOTA

2020- 卡罗拉/COROLLA  
2020- RAV4  
2019- 亚洲龙/AVALON  
2018- 奕泽/IZOA  
2021- 亚洲狮/ALLION/CHINA MODEL

KINFOR NO: **JR-BLT014**

**OE** 87103-06130

转向/ROTATION: **逆时针 CCW**

**适用车型/APPLICATION :**

FOR TOYOTA

2018- 凯美瑞/CAMRY  
2019- 雷凌/LEVIN  
2018- C-HR  
2020- 威兰达/WILDLANDER  
2021- 凌尚/LEVIN GT

KINFOR NO: **JR-BLT015**



**OE** 87103-60250

转向/ROTATION: **逆时针 CCW**

**适用车型/APPLICATION :**

FOR TOYOTA

1998-2006 陆巡/LANG CRUISER 100

FOR LEXUS

1998-2006 雷克萨斯/LEXUS LX470



鼓风机  
Heater Blower Motor

## 适用本田系列 FOR HONDA SERIES

KINFOR NO: **JR-BLH001**



**OE** 79310-TB0-H11

转向/ROTATION: **逆时针 CCW**

**适用车型/APPLICATION:**

**FOR HONDA**  
2008-2013 雅阁/ACCORD  
2011-2016 歌诗图/CROSSTOUR  
2010-2014 思铂睿/SPIRIOR

KINFOR NO: **JR-BLH002**



**OE** 79310-SWW-G01

转向/ROTATION: **逆时针 CCW**

**适用车型/APPLICATION:**

**FOR HONDA**  
2007-2011 CR-V

KINFOR NO: **JR-BLH003**



**OE** 79310-SFJ-W01

转向/ROTATION: **逆时针 CCW**

**适用车型/APPLICATION:**

**FOR HONDA**  
2006-2013 奥德赛/ODYSSEY

KINFOR NO: **JR-BLH004**



**OE** 79310-T0T-H01

转向/ROTATION: **逆时针 CCW**

**适用车型/APPLICATION:**

**FOR HONDA**  
2012-2016 CR-V  
2013- 杰德/JADE  
2016- 艾力绅/ELYSION  
2014- 奥德赛/ODYSSEY

**KINFOR NO: JR-BLH005**

**OE 79310-T2J-H01**

 转向/ROTATION: **逆时针 CCW**

适用车型/APPLICATION :

**FOR HONDA**  
 2014-2017 雅阁/ACCORD  
 2015-2017 思铂睿/SPIRIOR

**KINFOR NO: JR-BLH006**

**OE 79310-TET-H51  
79310-TVE-H01**

 转向/ROTATION: **逆时针 CCW**

适用车型/APPLICATION :

**FOR HONDA**  
 2018- 雅阁/ACCORD  
 2019- 英仕派/INSPIRE  
 2016- 思域/CIVIC

**KINFOR NO: JR-BLH007**

**OE 79310-TMO-G01  
79310-TF0-G01**

 转向/ROTATION: **逆时针 CCW**

适用车型/APPLICATION :

**FOR HONDA**  
 2009-2014 锋范/CITY  
 2009-2013 飞度/FIT/JAZZ

**KINFOR NO: JR-BLH008**

**OE 79310-T5H-H01  
79310-T7J-H01**

 转向/ROTATION: **逆时针 CCW**

适用车型/APPLICATION :

**FOR HONDA**  
 2015-2020 锋范/CITY  
 2014-2020 飞度/FIT/JAZZ  
 2016- 哥瑞/GREIZ  
 2017- 竞瑞/GIENIA  
 2014-2021 缤智/VEZEL  
 2014-2021 XR-V  
 2015-2018 凌派/CRIDER

KINFOR NO: **JR-BLH009**

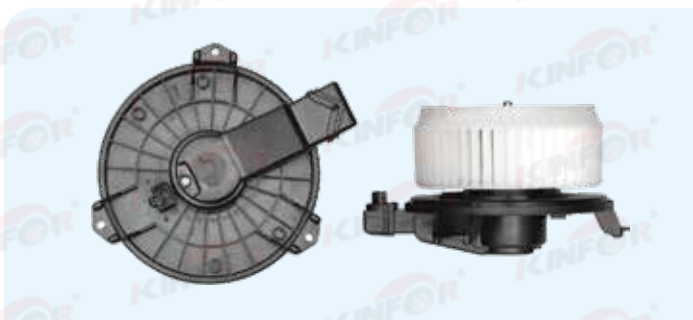

**OE** 79310-SNK-A01  
79310-SNA-A01

转向/ROTATION: **逆时针 CCW**

**适用车型/APPLICATION :**

FOR HONDA  
2006-2011 思域/CIVIC  
2012-2016 思铭/CIIMO

KINFOR NO: **JR-BLH010**



**OE** 79310-TS6-HO1

转向/ROTATION: **逆时针 CCW**

**适用车型/APPLICATION :**

FOR HONDA  
2012-2015 思域/CIVIC

KINFOR NO: **JR-BLH011**

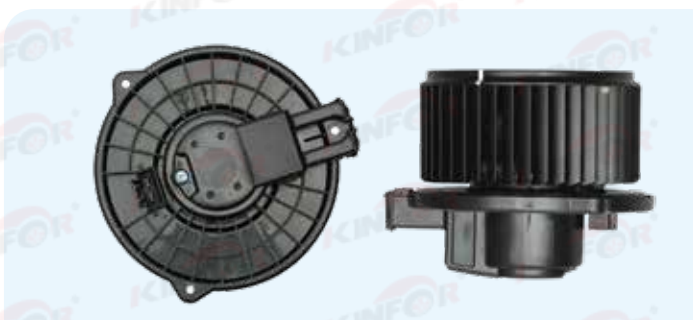

**OE** 79310-S84-A01

转向/ROTATION: **逆时针 CCW**

**适用车型/APPLICATION :**

FOR HONDA  
1998-2002 雅阁/ACCORD

KINFOR NO: **JR-BLH012**



**OE** 79310-SDG-000

转向/ROTATION: **逆时针 CCW**

**适用车型/APPLICATION :**

FOR HONDA  
2003-2007 雅阁/ACCORD

**KINFOR NO: JR-BLH013**

**OE 79310-SAA-G01**

 转向/ROTATION: **逆时针 CCW**

适用车型/APPLICATION:

**FOR HONDA**  
 2003-2008 飞度/FIT/JAZZ  
 2007-2008 思迪/CITY  
 2011- 理念 S1/EVERUS S1

**KINFOR NO: JR-BLH014**

**OE 79310-S7A-G12**

 转向/ROTATION: **逆时针 CCW**

适用车型/APPLICATION:

**FOR HONDA**  
 2002-2006 CR-V  
 2001-2005 时韵/STREAM

**KINFOR NO: JR-BLH015**

**OE 79310-TLA-A51**

 转向/ROTATION: **逆时针 CCW**

适用车型/APPLICATION:

**FOR HONDA**  
 2017 CR-V/皓影/BREEZE

**KINFOR NO: JR-BLH016**

**OE 79310-TBT-H01**

 转向/ROTATION: **逆时针 CCW**

适用车型/APPLICATION:

**FOR HONDA**  
 2019 凌派/CRIDER/享域/ENVIX



## 适用日产系列 FOR NISSAN SERIES

KINFOR NO: **JR-BLN001**



**OE** 27226-EE91A/ED50A  
27200-2FJ0A  
27226-2DU1B

转向/ROTATION: **逆时针 CCW**

**适用车型/APPLICATION:**

**FOR NISSAN**  
2006-2010 骐达/颐达/TIIDA  
2006-2011 轩逸/SYLPHY/SENTRA  
2006-2011 骊威/骏逸/LIVINA  
2010-2018 NV200  
2012-2016 启辰/VENUCIA D50  
2012-2016 启辰/VENUCIA R50  
2012-2016 经典轩逸/SYLPHY/SENTRA  
2013-2016 骊威/LIVINA

KINFOR NO: **JR-BLN002**



**OE** 27226-3DF0A/3RA0A/4AF1A/5MA1A

转向/ROTATION: **逆时针 CCW**

**适用车型/APPLICATION:**

**FOR NISSAN**  
2011- 骐达/TIIDA  
2013-2019 轩逸/SYLPHY  
2016- 蓝鸟/LANNIA

KINFOR NO: **JR-BLN003**



**OE** 27226-6LA0A

转向/ROTATION: **逆时针 CCW**

**适用车型/APPLICATION:**

**FOR NISSAN**  
2020 轩逸/SYLPHY/SENTRA

KINFOR NO: **JR-BLN004**



**OE** 27220-9W100

转向/ROTATION: **逆时针 CCW**

**适用车型/APPLICATION:**

**FOR NISSAN**  
2004-2007 天籁/TEANA/ALTIMA

**KINFOR NO: JR-BLN005**

**OE** 27225-JK61A/JK60B/3TA1A/3TA0A  
 27225-JK00A/JN00A

 转向/ROTATION: **逆时针 CCW**

适用车型/APPLICATION:

**FOR NISSAN**

- 2008-2018 天籁/TEANA/ALTIMA
- 2015-2018 楼兰/MURANO
- 2016- 西玛/MAXIMA
- 2013-2017 贵士/QUEST
- 2014-2018 英菲尼迪/INFINITI Q50L
- 2015-2017 英菲尼迪/INFINITI QX50
- 2008-2013 英菲尼迪 EX/FX/G系列/INFINITI EX/FX/G SERIES
- 2014-2016 英菲尼迪/INFINITI Q50
- 2013-2014 英菲尼迪/INFINITI Q60
- 2013-2014 英菲尼迪/INFINITI QX50
- 2014-2016 英菲尼迪/INFINITI QX60
- 2013-2017 英菲尼迪/INFINITI QX70

**KINFOR NO: JR-BLN006**

**OE** 27220-5NN0A/5NN1A

 转向/ROTATION: **逆时针 CCW**

适用车型/APPLICATION:

**FOR NISSAN**

- 2019- 天籁/ALTIMA
- 2018- 英菲尼迪/INFINITI QX50

**KINFOR NO: JR-BLN007**

**OE** 27226-8M500

 转向/ROTATION: **逆时针 CCW**

适用车型/APPLICATION:

**FOR NISSAN**

- 2004-2009 阳光/SUNNY

**KINFOR NO: JR-BLN008**

**OE** 27226-1HM0A/3AW1B/6W80A

 转向/ROTATION: **逆时针 CCW**

适用车型/APPLICATION:

**FOR NISSAN**

- 2010-2016 阳光/SUNNY
- 2010-2015 玛驰/MARCH

KINFOR NO: **JR-BLN009**



**OE** 27226-JE20A/EN000/ET00A/JD00A

转向/ROTATION: **逆时针 CCW**

**适用车型/APPLICATION :**

**FOR NISSAN**  
2008-2014 逍客/QASHQAI  
2008-2013 奇骏/X-TRAIL ROGUE

KINFOR NO: **JR-BLN010**



**OE** 27226-4BC0A

转向/ROTATION: **逆时针 CCW**

**适用车型/APPLICATION :**

**FOR NISSAN**  
2014-2010 奇骏/X-TRAIL ROGUE

KINFOR NO: **JR-BLN011**



**OE** 27226-DF30A

转向/ROTATION: **逆时针 CCW**

**适用车型/APPLICATION :**

**FOR NISSAN**  
2015-2020 逍客/QASHQAI ROGUE SPORT

KINFOR NO: **JR-BLN012**



**OE** 27220-JK00A/JK00C/JK00D/JK01A

转向/ROTATION: **逆时针 CCW**

**适用车型/APPLICATION :**

**FOR NISSAN**  
2012- 途乐/PATROL  
2011- 英菲尼迪/INFINITI QX80  
2011-2013 英菲尼迪/INFINITI QX56

KINFOR NO: JR-BLN013

**OE** 27220-4JG0A/4JA0A

转向/ROTATION: 逆时针 CCW

 适用车型/APPLICATION :

FOR NISSAN  
2018- 途达/TERRA  
2015- 纳瓦拉/NAVARA NP300