

CONTENTS

01 - 02

ABOUT US

03 - 13

ASA-PVC CO-EXTRUDED
OUTDOOR WALL PANEL

14 - 17

PVC OUTDOOR DECKING

18 - 20

PVC OUTDOOR FENCING

21 - 22

ASA-PVC CO-EXTRUDED
OUTDOOR TUBE

23 - 31

WPC DOOR
ACCESSORIES SERIES

ABOUT

1

Anhui Guanming Decoration Materials Co., Ltd

Our factory was founded over 20 years ago, and we have more than 15 years of export experience. Specializes in high-quality outdoor ASA/PVC co-extruded composite materials, including decking, wall cladding, fencing, and more.

Nowadays, more and more customers have put forward higher requirements for building materials with functions such as fire prevention, sound insulation, moisture-proof, insect-proof, heat insulation, etc. In order to become a manufacturer with market competitiveness, we have established a research and development center and introduced automated equipment to produce new functional building materials.

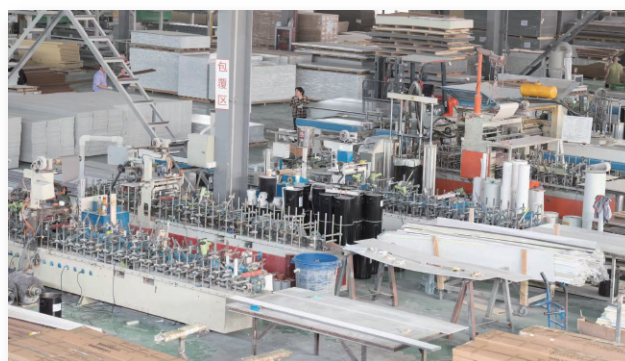

2

We have cooperation cases in Europe, South America, the Middle East, Africa, East Asia, and North America, providing product customization for local customers to perfectly adapt to local climate, policies, and other conditions. We serve both MID-range and premium customers in the outdoor construction industry, delivering products that combine durability, aesthetics, and Eco-friendliness.



We have established a professional export service system, including quality control, CAD design, technical department, and after-sales service to meet the needs of customers.

The corporate culture of Anhui Guanming Decoration Materials Co., Ltd is integrity, focus, and professionalism.

The whole team welcomes friends from all over the world to negotiate business.



Product Characteristics

The product is mainly used as an outdoor wall. Simple installation method, natural wood texture, and healthy and environmentally friendly zero formaldehyde release water-proof, anti-corrosion, mothproof, suitable for home and public place decoration.

Product Cross-sectional View

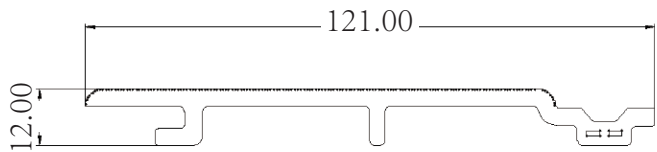

Recommended Colors



Package	Package Dimensions	Maximum packing capacity	
20pcs/pkg	2920*140*85mm	20GP	40HQ
		8310	17660

Common Accessories



Wall Panel Keel



Wall Panel Clasp



Expansion Screws



Easy To Install



Waterproof



Fire Protection



Easy To Clean



No Distortion



Eco-friendly



Pest Control



Product Characteristics

The product is mainly used as an outdoor wall. Simple installation method, natural wood texture, and healthy and environmentally friendly zero formaldehyde release water-proof, anti-corrosion, mothproof, suitable for home and public place decoration.



Product Cross-sectional View

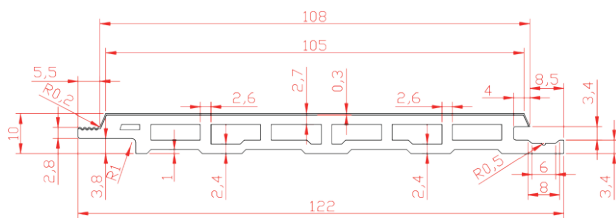

Package	Package Dimensions	Maximum packing capacity	
20pcs/pkg	2920*140*85mm	20GP	40HQ
		8310	17660

Recommended Colors



Common Accessories



Wall Panel Keel



Wall Panel Clasp



Expansion Screws



Easy To Install



Waterproof



Fire Protection



Easy To Clean



No Distortion



Eco-friendly



Pest Control



Product Characteristics

The product is mainly used as an outdoor wall. Simple installation method, natural wood texture, and healthy and environmentally friendly zero formaldehyde release water-proof, anti-corrosion, mothproof, suitable for home and public place decoration.

Product Cross-sectional View

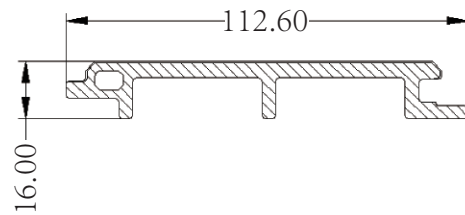

Recommended Colors



Package	Package Dimensions	Maximum packing capacity	
10pcs/pkg	2920*135*111mm	20GP	40HQ
		6630	13240

Common Accessories



Wall Panel Keel



Wall Panel Clasp



Expansion Screws



Easy To Install



Waterproof



Fire Protection



Easy To Clean



No Distortion



Eco-friendly



Pest Control



Product Characteristics

The product is mainly used as an outdoor wall. Simple installation method, natural wood texture, and healthy and environmentally friendly zero formaldehyde release. Waterproof, anti-corrosion, mothproof, suitable for home and public place decoration.



Product Cross-sectional View

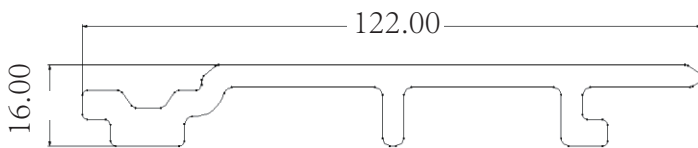

Package	Package Dimensions	Maximum packing capacity	
		20GP	40HQ
10pcs/pkg	2920*135*111mm	6630	13240

Recommended Colors



Common Accessories



Wall Panel Keel



Wall Panel Clasp



Expansion Screws



Easy To Install



Waterproof



Fire Protection



Easy To Clean



No Distortion



Eco-friendly



Pest Control





Product Characteristics

This product is a semi-finished wall covering primarily used for light-blocking applications. It features easy installation, natural textures, and is healthy and eco-friendly with zero formaldehyde emissions. It offers waterproof, anti-corrosion, and anti-termite properties, making it suitable for both residential and public space decoration.

Product Cross-sectional View

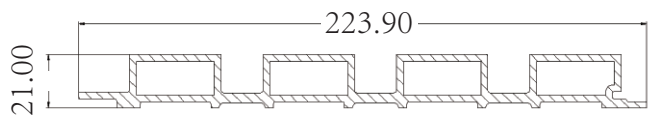

Recommended Colors



Package	Package Dimensions	Maximum packing capacity	
		20GP	40HQ
4pcs/pkg	2920*230*90mm	1924	4552
		20GP	40HQ

Common Accessories



-  Easy To Install
-  Waterproof
-  Fire Protection
-  Easy To Clean
-  No Distortion
-  Eco-friendly
-  Pest Control



Product Characteristics

The product is mainly used as an outdoor wall. Simple installation method, natural wood texture, and healthy and environmentally friendly zero formaldehyde release water-proof, anti-corrosion, mothproof, suitable for home and public place decoration.



Product Cross-sectional View

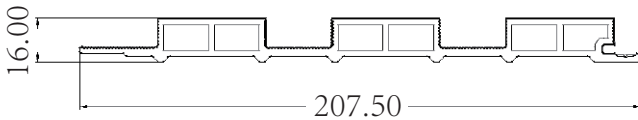

Package	Package Dimensions	Maximum packing capacity	
8pcs/pkg	2920*140*85mm	20GP	40HQ
		4980	8148

Recommended Colors



Common Accessories



Wall Panel Keel



Wall Panel Clasp



Expansion Screws



Easy To Install



Waterproof



Fire Protection



Easy To Clean



No Distortion



Eco-friendly



Pest Control



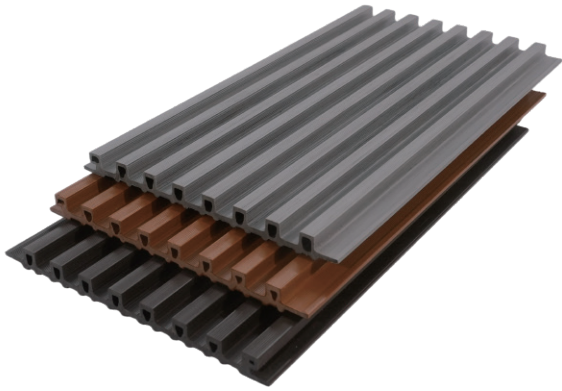

Product Characteristics

The product is mainly used as an outdoor wall. Simple installation method, natural wood texture, and healthy and environmentally friendly zero formaldehyde release water-proof, anti-corrosion, mothproof, suitable for home and public place decoration.

Product Cross-sectional View

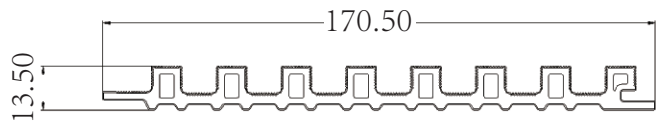

Recommended Colors



Package	Package Dimensions	Maximum packing capacity	
12pcs/pkg	2920*187*114mm	20GP	40HQ
		5616	8952

Common Accessories



Wall Panel Keel



Wall Panel Clasp



Expansion Screws



Easy To Install



Waterproof



Fire Protection



Easy To Clean



No Distortion



Eco-friendly



Pest Control



Product Characteristics

The product is mainly used as an outdoor wall. Simple installation method, natural wood texture, and healthy and environmentally friendly zero formaldehyde release water-proof, anti-corrosion, mothproof, suitable for home and public place decoration.



Product Cross-sectional View



Package	Package Dimensions	Maximum packing capacity	
8pcs/pkg	2920*195*168mm	20GP	40HQ
		4980	8148

Recommended Colors



Common Accessories



Wall Panel Keel



Wall Panel Clasp



Expansion Screws



Easy To Install



Waterproof



Fire Protection



Easy To Clean



No Distortion



Eco-friendly



Pest Control



Product Characteristics

The product is mainly used as an outdoor wall. Simple installation method, natural wood texture, and healthy and environmentally friendly zero formaldehyde release water-proof, anti-corrosion, mothproof, suitable for home and public place decoration.

Product Cross-sectional View

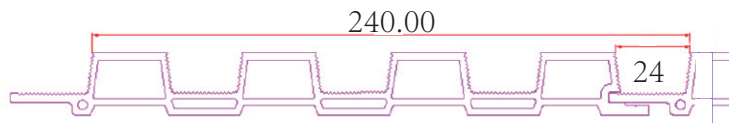

Recommended Colors



Package	Package Dimensions	Maximum packing capacity	
		20GP	40HQ
4pcs/pkg	2920*246*150mm	1620	3440

Common Accessories



- Easy To Install
- Waterproof
- Fire Protection
- Easy To Clean
- No Distortion
- Eco-friendly
- Pest Control



Product Characteristics

The product is mainly used as an outdoor wall. Simple installation method, natural wood texture, and healthy and environmentally friendly zero formaldehyde release water-proof, anti-corrosion, mothproof, suitable for home and public place decoration.



Product Cross-sectional View

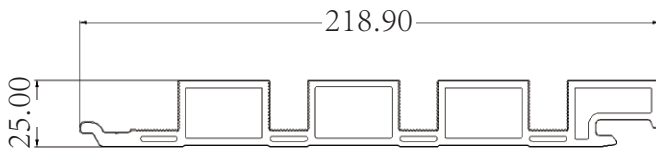

Package	Package Dimensions	Maximum packing capacity	
6pcs/pkg	2920*235*150mm	20GP	40HQ
		1710	3960

Recommended Colors



Common Accessories



Wall Panel Keel



Wall Panel Clasp



Expansion Screws



Easy To Install



Waterproof



Fire Protection



Easy To Clean



No Distortion



Eco-friendly



Pest Control



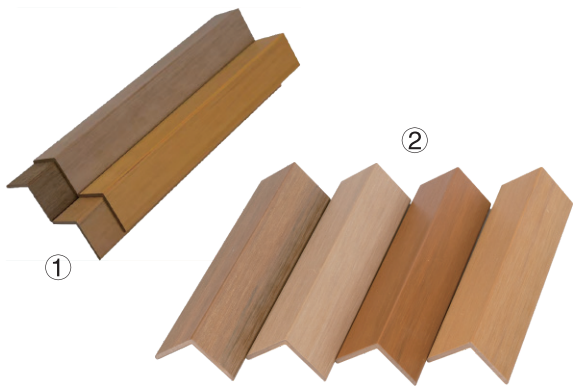

Product Characteristics

This product is primarily used as an exterior wall cladding trim. It features easy installation, natural grain patterns, and eco-friendly properties with zero formaldehyde emissions. Additionally, it offers waterproofing, corrosion resistance, and protection against wood-boring insects. Suitable for residential and public space decoration.

Product Cross-sectional View

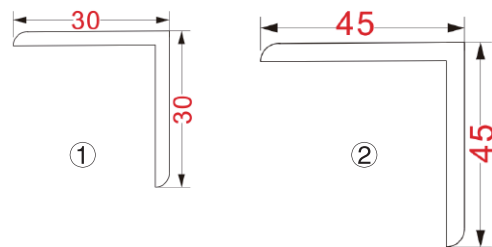

Recommended Colors



Package	Package Dimensions	Maximum packing capacity	
		20GP	40HQ
20pcs/pkg	2920*160*48mm	26000	52000

Common Accessories



- Easy To Install
- Waterproof
- Fire Protection
- Easy To Clean
- No Distortion
- Eco-friendly
- Pest Control



Product Characteristics

ASA (Acrylic Styrene Acrylonitrile) decking is a high-performance, capped polymer decking board. It's part of the newer generation of synthetic decking materials, often positioned as a premium alternative to wood and PVC decking.



Product Cross-sectional View

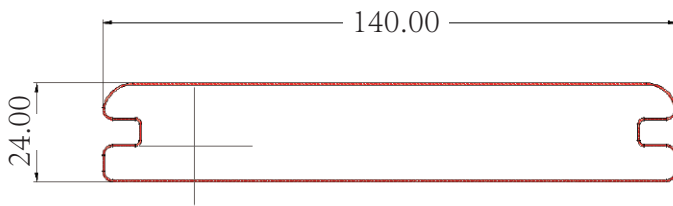

Package	Package Dimensions	Maximum packing capacity	
		20GP	40HQ
8pcs/pkg	2920*146*198mm	3072	6144

Recommended Colors



Common Accessories

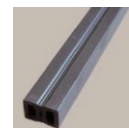

WPC Joist

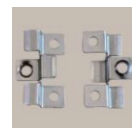

Iron Clip



Plastic Clip



Nail For Joist



Easy To Install



Waterproof



Fire Protection



Easy To Clean



No Distortion



Eco-friendly



Pest Control



Product Characteristics

ASA (Acrylic Styrene Acrylonitrile) decking is a high-performance, capped polymer decking board. It's part of the newer generation of synthetic decking materials, often positioned as a premium alternative to wood and PVC decking.

Product Cross-sectional View

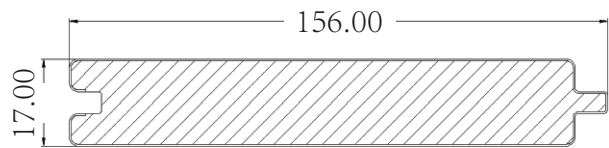

Recommended Colors



Package	Package Dimensions	Maximum packing capacity	
		20GP	40HQ
8pcs/pkg	2920*162*142mm	3584	7168

Common Accessories

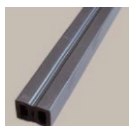

WPC Joist

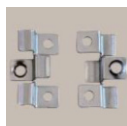

Iron Clip



Plastic Clip



Nail For Joist



Easy To Install



Waterproof



Fire Protection



Easy To Clean



No Distortion



Eco-friendly



Pest Control



Product Characteristics

PVC laminate flooring is a high-performance polymer flooring material designed specifically for outdoor applications. This laminate offers scratch resistance, scuff resistance, oxidation resistance, UV resistance, and fade resistance. It is often positioned as a premium alternative to wood and PVC flooring.



Product Cross-sectional View



Package	Package Dimensions	Maximum packing capacity	
8pcs/pkg	2920*156*206mm	20GP	40HQ
		2640	5760

Common Accessories

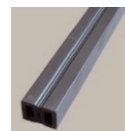

WPC Joist



Iron Clip



Plastic Clip

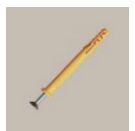

Nail For Joist



Easy To Install



Waterproof



Fire Protection



Eco-friendly



Easy To Clean



No Distortion



Pest Control



①



②

Product Characteristics

PVC laminate flooring is a high-performance polymer flooring material designed specifically for outdoor applications. This laminate offers scratch resistance, scuff resistance, oxidation resistance, UV resistance, and fade resistance. It is often positioned as a premium alternative to wood and PVC flooring.

Product Cross-sectional View

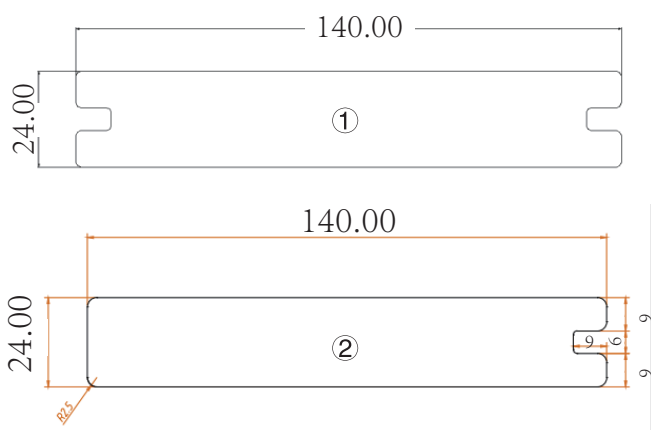

Package	Package Dimensions	Maximum packing capacity	
		20GP	40HQ
8pcs/pkg	2920*156*206mm	2640	5760

Common Accessories

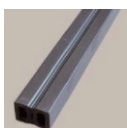

WPC Joist



Iron Clip



Plastic Clip



Nail For Joist



Easy To Install



Waterproof



Fire Protection



Easy To Clean



No Distortion



Eco-friendly



Pest Control



Product Characteristics

ASA (Acrylic Styrene Acrylonitrile) decking is a high-performance, capped polymer decking board. It's part of the newer generation of synthetic decking materials, often positioned as a premium alternative to wood and PVC decking.



Product Cross-sectional View

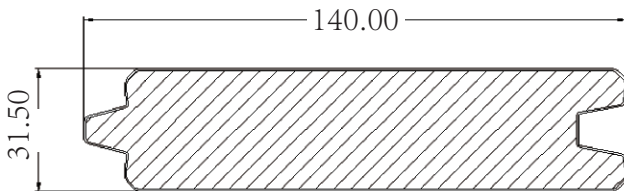

Package	Package Dimensions	Maximum packing capacity	
6pcs/pkg	2920*146*198mm	20GP	40HQ
		2304	4608

Recommended Colors



Common Accessories



Wall Panel Keel



Wall Panel Clasp



Expansion Screws



Easy To Install



Waterproof



Fire Protection



Easy To Clean



No Distortion



Eco-friendly



Pest Control





Product Characteristics

PVC-coated outdoor fence panels are high-performance polymer flooring boards with diverse color options, offering advantages such as wear resistance, scratch resistance, and UV protection. They are often positioned as a premium alternative to wood and PVC flooring.

Product Cross-sectional View

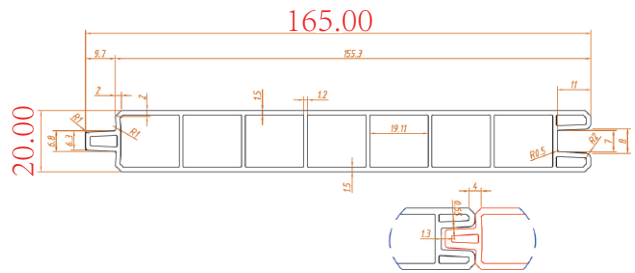

Regular Style



Package	Package Dimensions	Maximum packing capacity	
		20GP	40HQ
10pcs/pkg	2920*171*206mm	2860	6240



Product Characteristics

PVC ceiling panels are used for indoor ceilings. Available in a variety of colors and wood grain patterns, they are a popular ceiling panel exported to Europe and America, offering superior quality compared to standard ceiling panels on the market.

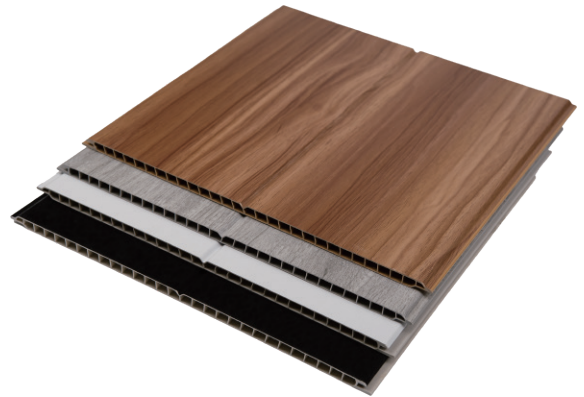

Product Cross-sectional View

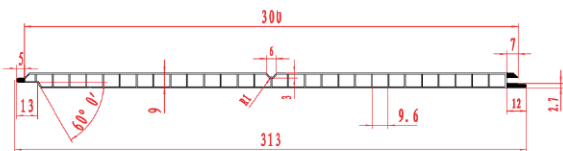

Package	Package Dimensions	Maximum packing capacity	
6pcs/pkg	2920*315*65mm	20GP	40HQ
		6220	16365

Common Accessories



Wall Panel Keel



Wall Panel Clasp



Expansion Screws



Easy To Install



Waterproof



Fire Protection



Eco-friendly



Easy To Clean



No Distortion



Pest Control



Product Characteristics

WPC tubes are not used for primary structural load-bearing (like building frames) but are excellent for secondary structures and frameworks.

False Ceiling Grids: Used as the supporting grid for lightweight false ceilings in patios, pergolas, or interior spaces. They are moisture-resistant and won't sag like wood.

Product Cross-sectional View

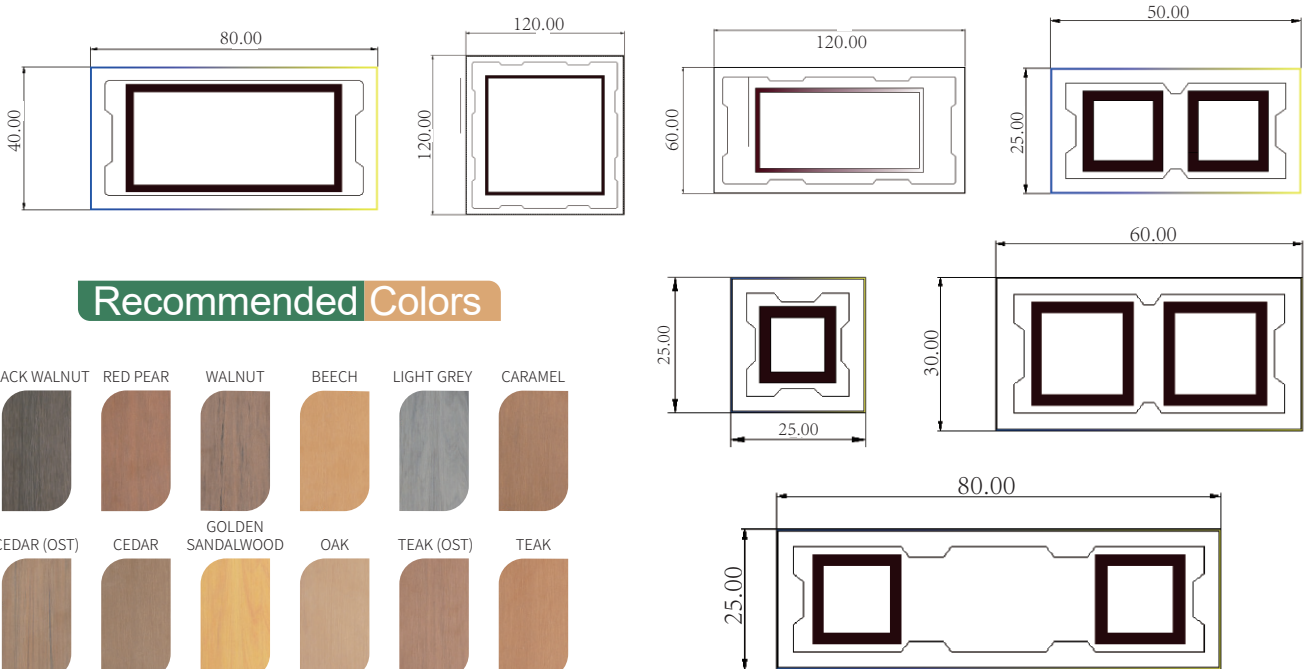

Recommended Colors



Easy To Install



Waterproof



Fire Protection



Easy To Clean



No Distortion



Eco-friendly



Pest Control

CASE



Product Characteristics

Wpc door panel is the best resin material with the advantages of green environmental protection, waterproof, fireproof, mould-proof and insect-proof, and can be customised according to customer requirements. Export to Southeast Asia, Arabia and other regions

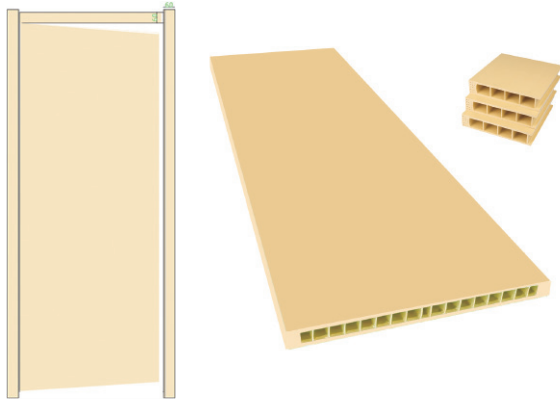

Product Cross-sectional View

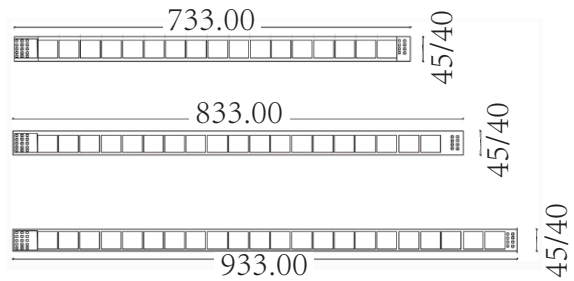

Door core board are packaged on pallets: 50 pcs per pallet.

Size	Pallet Size	Maximum packing capacity
2100*733*40mm	2100*743*2350mm	50PCS/Pallet
2100*833*40mm	2120*843*2350mm	
2100*933*40mm	2100*943*2350mm	

-  Easy To Install
-  Waterproof
-  Fire Protection
-  Easy To Clean
-  No Distortion
-  Eco-friendly
-  Pest Control



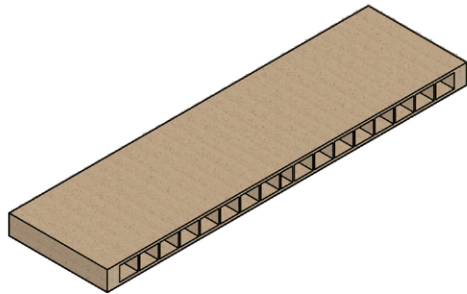
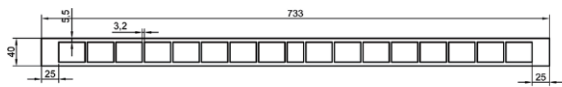

733-40-5.5

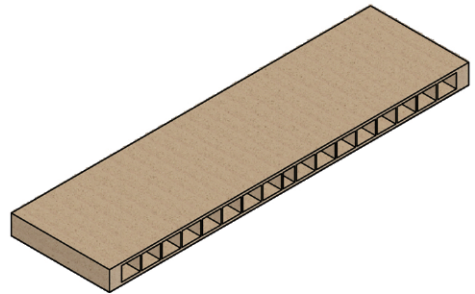
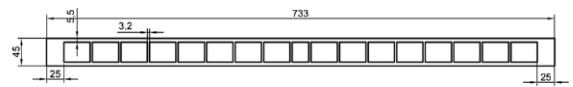

733-45-5.5

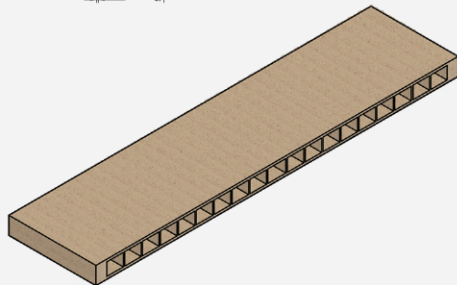
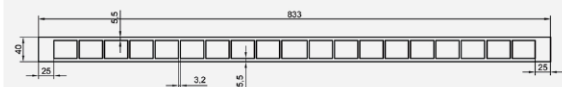

833-40-5.5

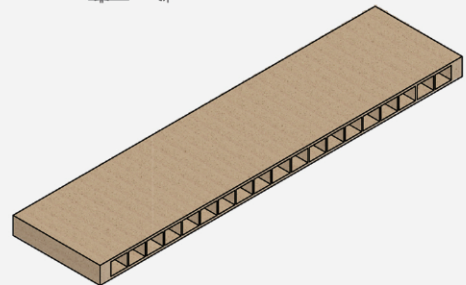
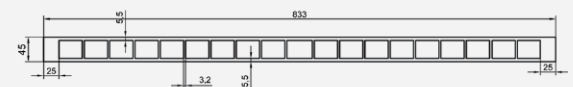

833-45-5.5

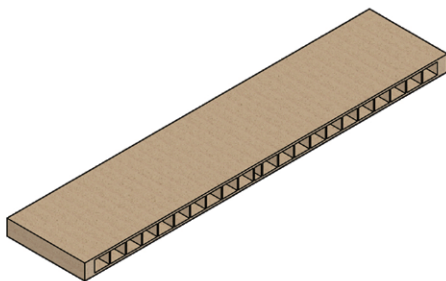
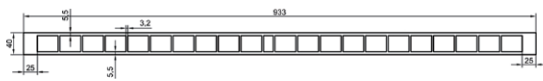

933-40-5.5

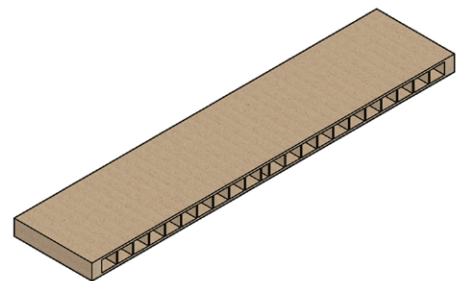
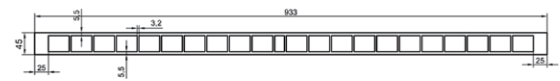

933-45-5.5

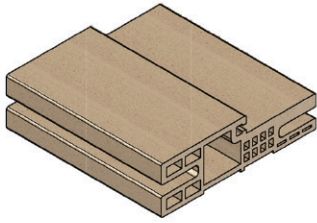
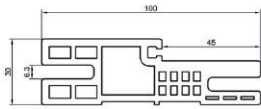

100-45

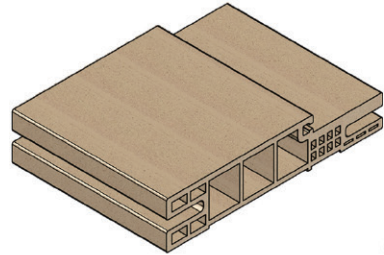
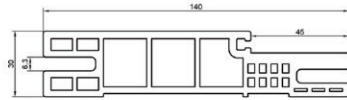

140-45

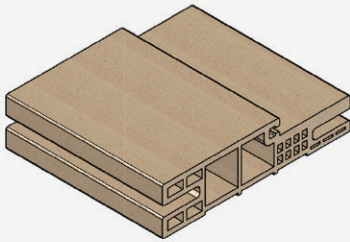
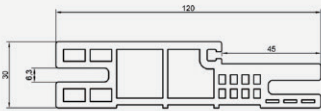

120-45

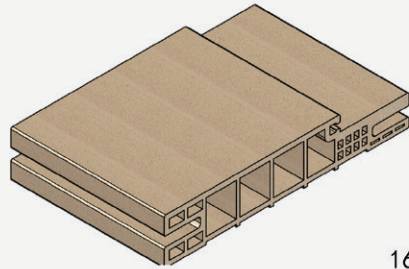
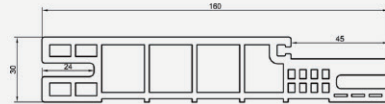

160-45

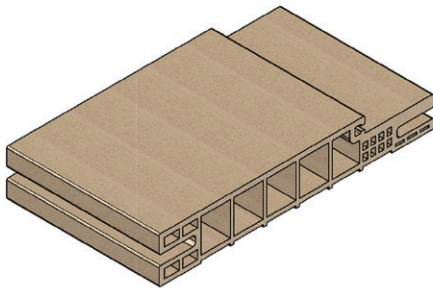
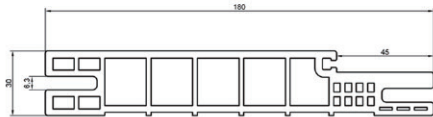

180-45

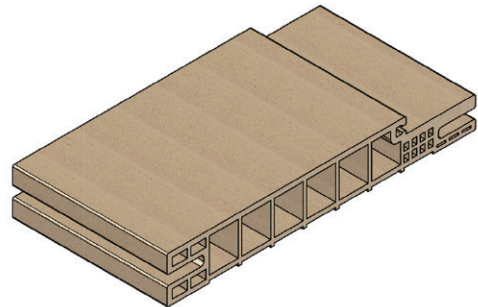
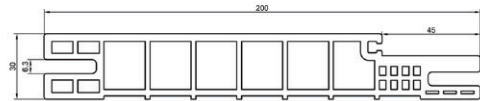

200-45

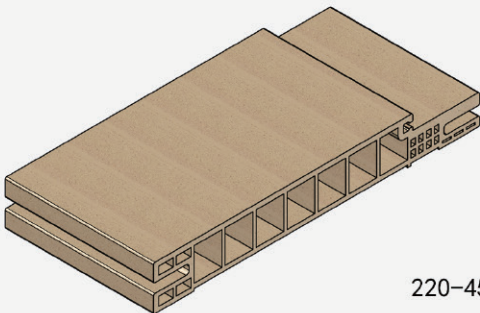
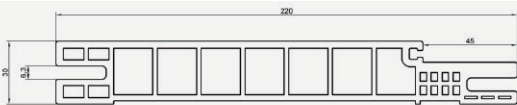

220-45

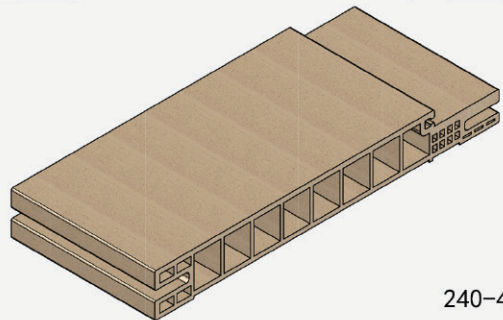

240-45

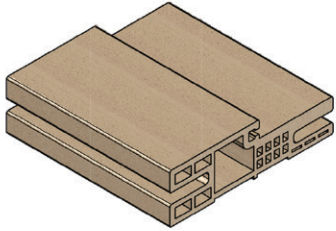
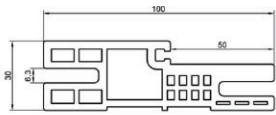

100-50

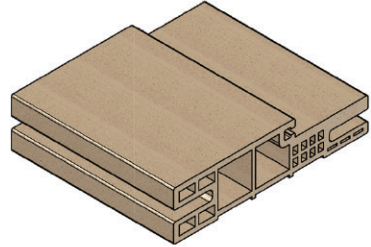
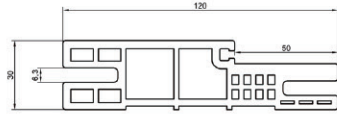

120-50

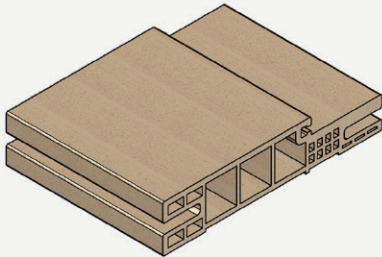
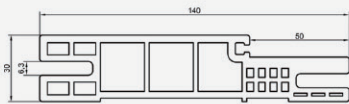

140-50

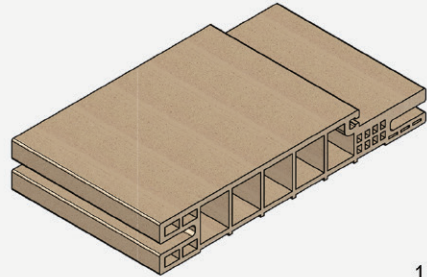
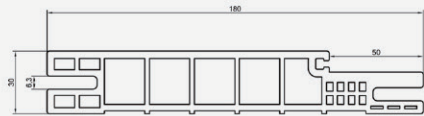

180-50

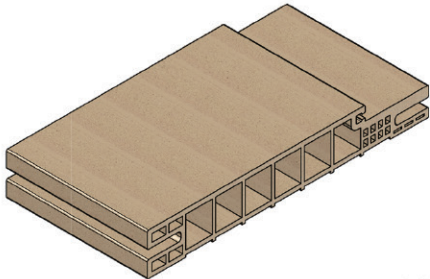
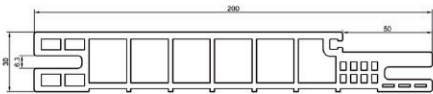

200-50

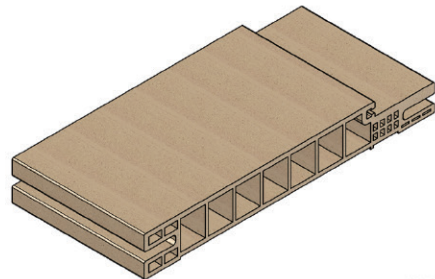
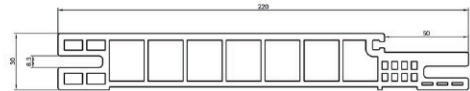

220-50

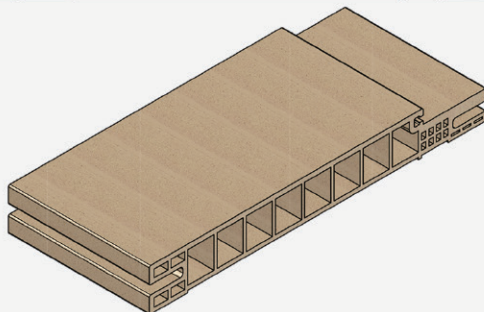
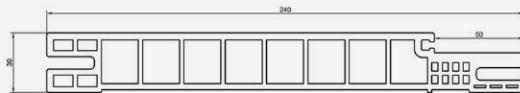

240-50

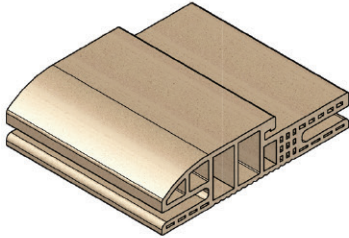
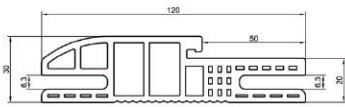

120-50

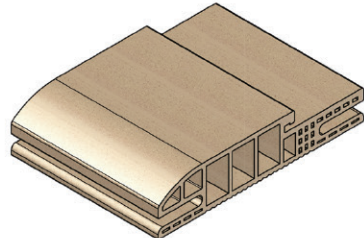
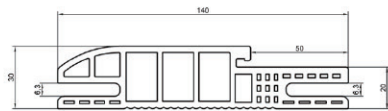

140-50

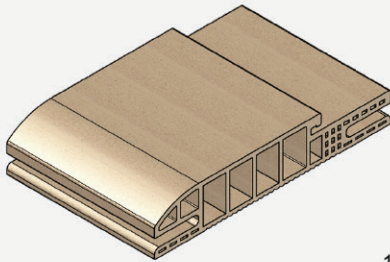
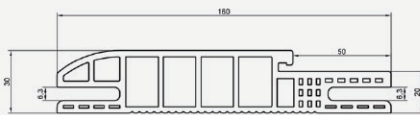

160-50

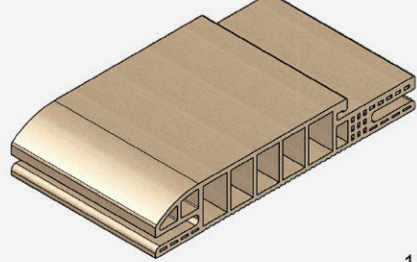

180-50

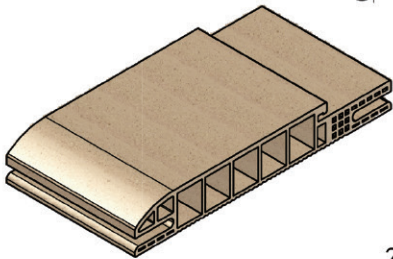
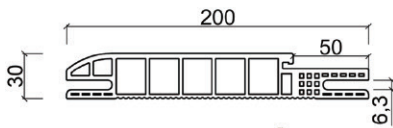

200-50

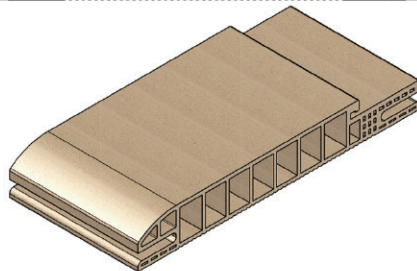
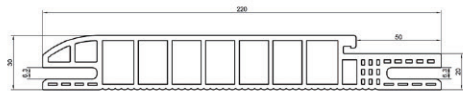

220-50

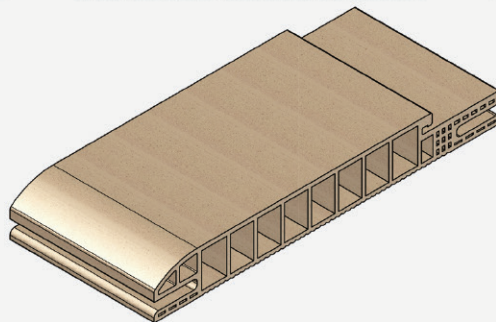
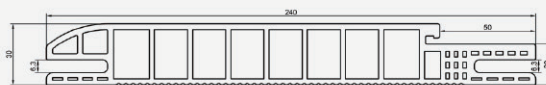

240-50

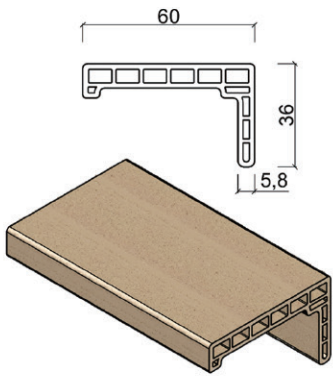

L60-36

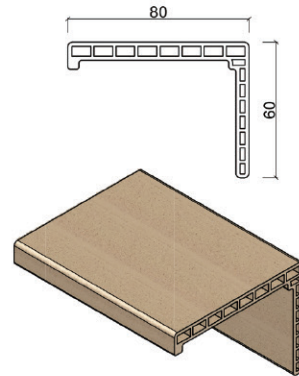

L80-60

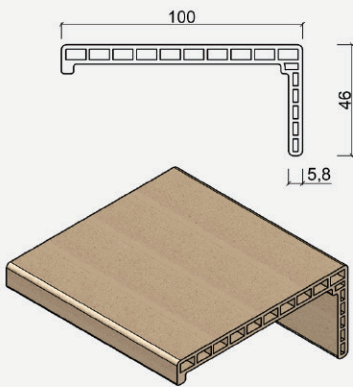

L100-46

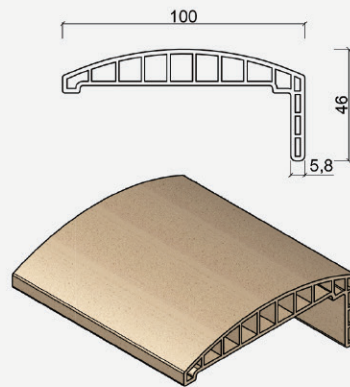

R100-46

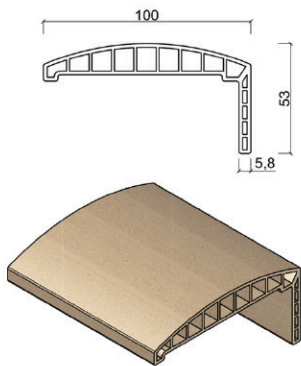

R100-53

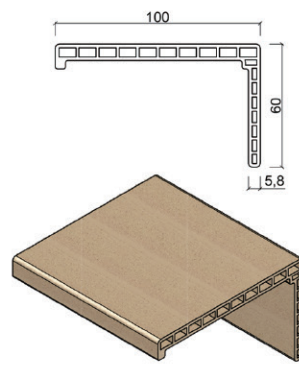

L100-60

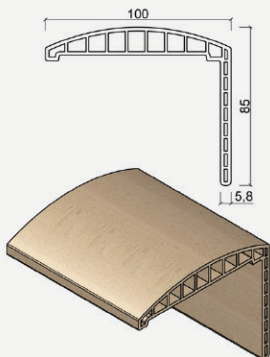

R100-85

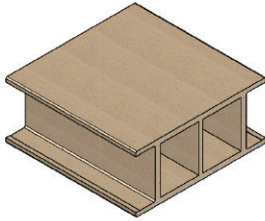
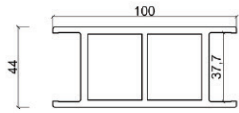

ZH100-44

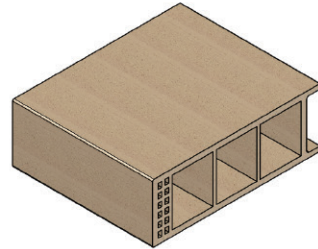
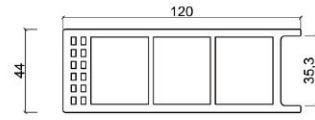

BK120-44

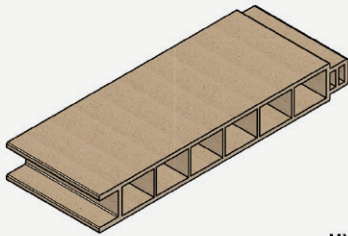
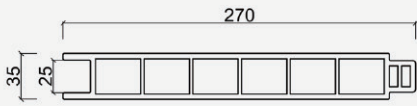

MXB270-35

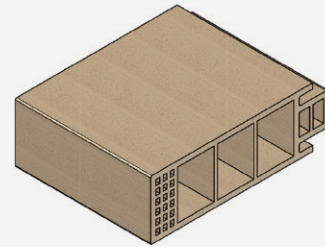
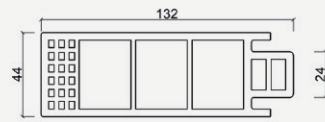

BK132-44

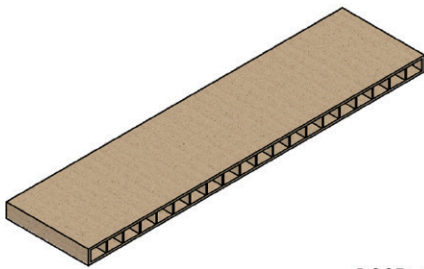
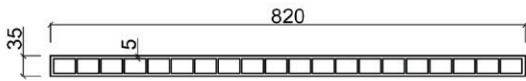

D00R 820-35

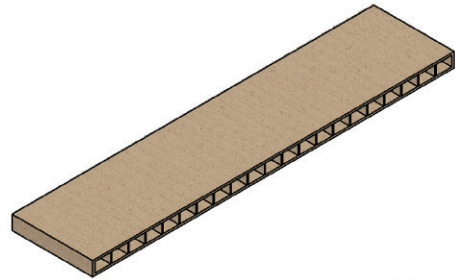
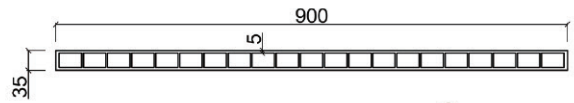

D00R 900-35

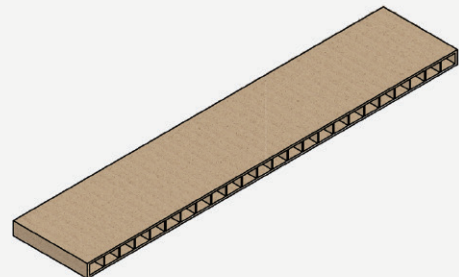
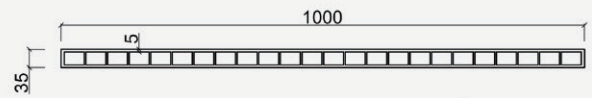
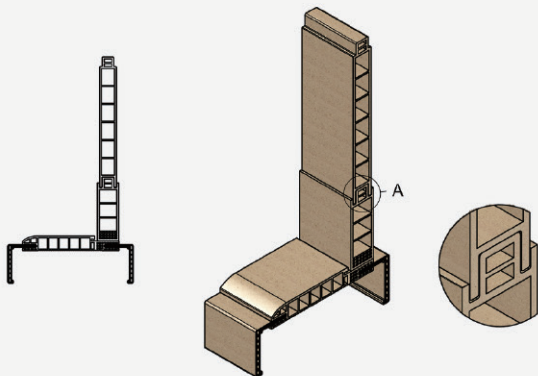

D00R 1000-35

90*40 Central Beam

220*50 Door Frame



80*36 Door Architrave

220*50 Door Frame

80*40 Door Frame

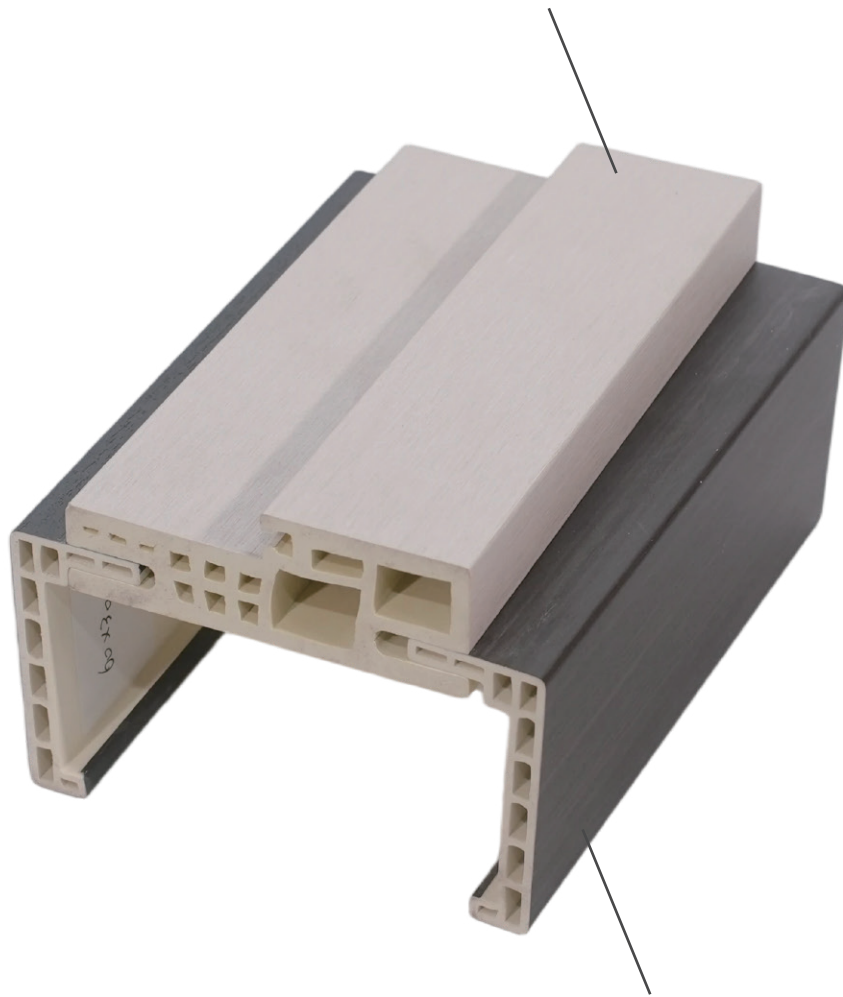

60*30 Door Architrave