

# LED Garden Light

## LED 庭院灯

### 产品说明 Product description

#### 材质工艺:

- 灯具设计风格简约时尚、精致典雅、浪漫古典、与城市美化完美结合。
- 灯体采用 6063 铝合金型材制造，灯杆坚韧度高，材料回收率高。
- 灯具光源部分采用高品质 LED 芯片及电源，灯体侧面发光部分则配用 LED 灯带结合：红光、蓝光、绿光、黄光、白光及 RGB 七彩变色。
- 灯体外部采用纳米多功能涂层、防粘贴、防涂鸦、防刮痕。
- 灯具应用场所：公园、商业区、高档别墅庭院、停车场、广场、道路行人道等。

#### Material and Technology:

- The product design creating is concise and fashion/delicate and elegant/classics and romantic/perfect combination and city beautification.
- The lamp body using for 6063 aluminum material,the lamp pole is high tenacity and metal material will be high reclaim.
- The light source with high quality LED chips and power supply,the lamp pole two side with LED strip for color:red/blue/green/yellow/white and RGB full color change.
- The lamp pole with Nano multi-functional coating/prevent paste/prevent scrawl/prevent scratching.
- The lamp application places:public garden/bussiness area/luxury villa garden/ park/plaza/pavements of road .etc.

### 配光曲线 Light Distribution Curve

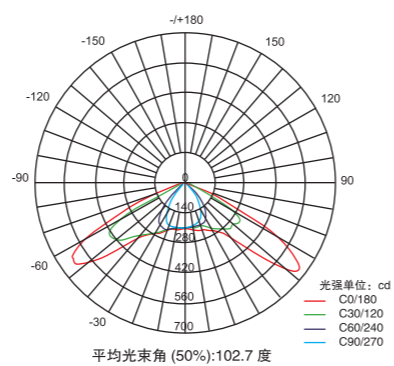

JB-SL001B1



### 技术参数 Technology information

产品型号 Product Code	JB-SL001A1	JB-SL001B1	JB-SL001C1
灯体尺寸 Lamp size	 150 x 100mm	 150 x 75mm	 130 x 85mm
产品高度 Product height	4M-6M	3M-4M	3M-3.5M
功率 Power	30W	20W	20W
灯体材质 Lamp material	6063 Aluminum material		
色温 Color temp	3000K / 6000K		
灯带颜色 Strip color temp	Blue / Green / Red / Pink / Warm white		
芯片 LED chips	PHILIPS / CREE / BRIGDELUX		
透镜角度 Lens angle	120°70°		
效率 Efficiency	87%		
防护等级 Protection levels	IP65		



JB-SL002C1 JB-SL126I2 JB-SL129I2

**产品说明 Product description**

**材质工艺:**

- 灯具设计风格简约时尚、精致典雅、浪漫古典、与城市美化完美结合。
- 灯体采用 6063 铝合金材制造，灯杆坚韧度高，材料回收率高。
- 灯具光源部分采用高品质 LED 芯片及电源，灯体侧面发光部分则配用 LED 灯带结合：红光、蓝光、绿光、黄光、白光及 RGB 七彩变色。
- 灯体外部采用纳米多功能涂层、防粘贴、防涂鸦、防刮痕。
- 灯具应用场所：公园、商业区、高档别墅庭院、停车场、广场、道路行人道等。



**Material and Technology:**

- The product design creating is concise and fashion/delicate and elegant/classics and romantic/perfect combination and city beautification.
- The lamp body using for 6063 aluminum material,the lamp pole is high tenacity and metal material will be high reclaim.
- The light source with high quality LED chips and power supply,the lamp pole two side with LED strip for color:red/blue/green/yellow/white and RGB full color change.
- The lamp pole with Nano multi-fanctional coating/prevent paste/prevent scrawl/prevent scratching.
- The lamp application places:public garden/bussiness area/luxury villa garden/ park/plaza/pavements of road ,etc.

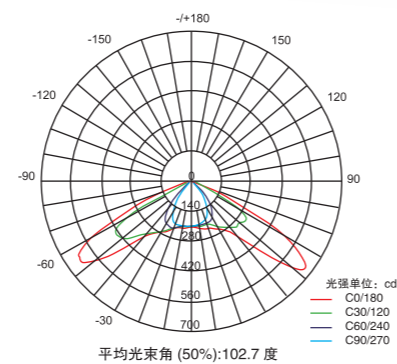
**配光曲线 Light Distribution Curve**

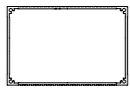
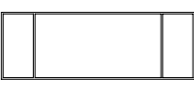

**技术参数 Technology information**

产品型号 Product Code	JB-SL002C1	JB-SL126I2	JB-SL129I2
灯体尺寸 Lamp size	 130 x 85mm	 230 x 80mm	 150 x 100mm
产品高度 Product height	3M-4M	3M-4M	3M-4M
功率 Power	30-40W	30-40W	30-40W
灯体材质 Lamp material	6063 Aluminum material		
色温 Color temp	3000K / 6000K		
灯带颜色 Strip color temp	Blue / Green / Red / Pink / Warm white		
芯片 LED chips	PHILIPS / CREE / BRIGDELUX		
透镜角度 Lens angle	120°70°		
效率 Efficiency	87%		
防护等级 Protection levels	IP65		

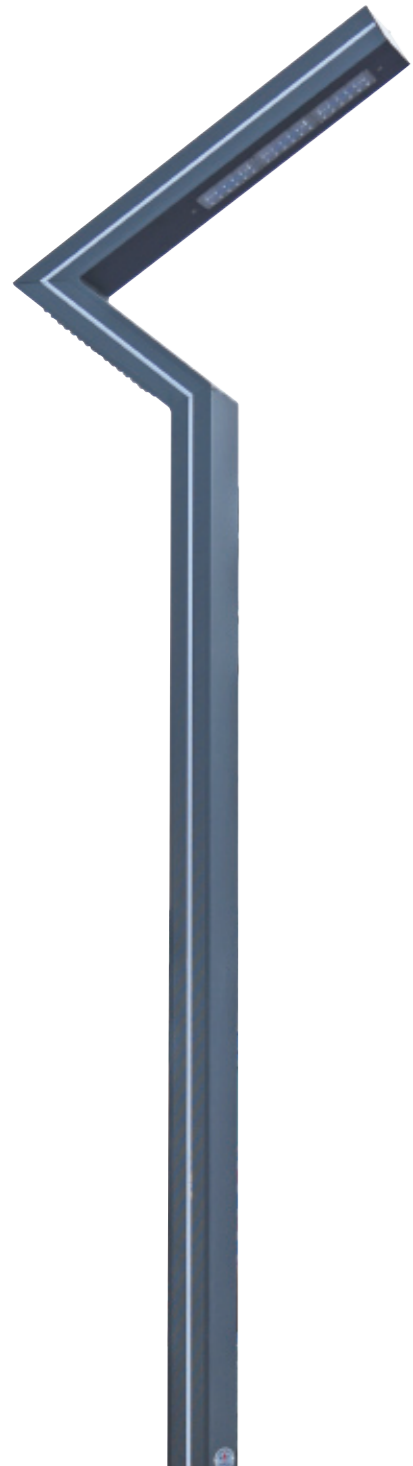

**产品说明 Product description**

**材质工艺:**

- 灯具设计风格简约时尚、精致典雅、浪漫古典、与城市美化完美结合。
- 灯体采用 6063 铝合金型材制造，灯杆坚韧度高，材料回收率高。
- 灯具光源部分采用高品质 LED 芯片及电源，灯体侧面发光部分则配有 LED 灯带结合：红光、蓝光、绿光、黄光、白光及 RGB 七彩变色。
- 灯体外部采用纳米多功能涂层、防粘贴、防涂鸦、防刮痕。
- 灯具应用场所：公园、商业区、高档别墅庭院、停车场、广场、道路行人道等。

**Material and Technology:**

- The product design creating is concise and fashion/delicate and elegant/classics and romantic/perfect combination and city beautification.
- The lamp body using for 6063 aluminum material,the lamp pole is high tenacity and metal material will be high reclaim.
- The light source with high quality LED chips and power supply,the lamp pole two side with LED strip for color:red/blue/green/yellow/white and RGB full color change.
- The lamp pole with Nano multi-fanctional coating/prevent paste/prevent scrawl/prevent scratching.
- The lamp application places:public garden/bussiness area/luxury villa garden/ park/plaza/pavements of road ,etc.

**配光曲线 Light Distribution Curve**

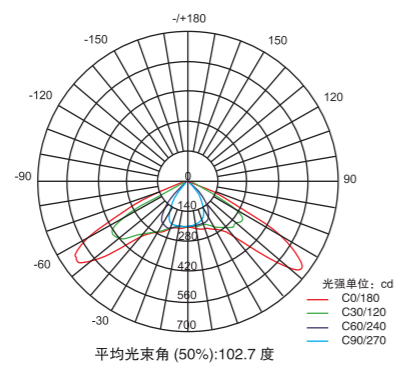

**JB-GN001**

专利号: 201630614652.4

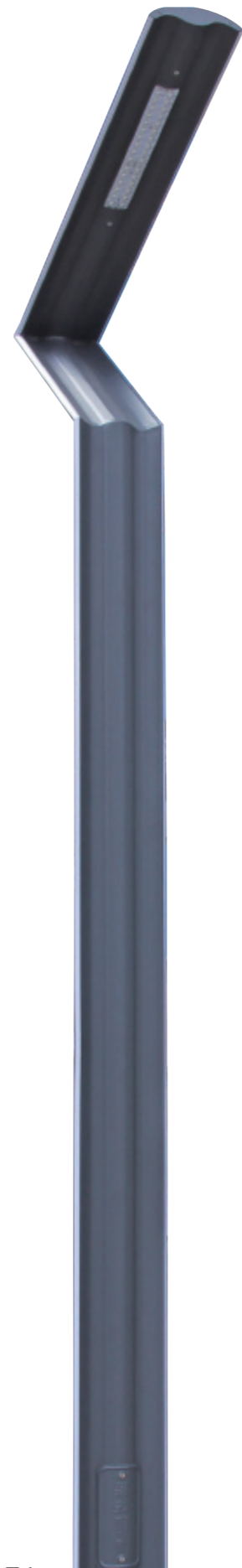





**JB-GN001E1**



**JB-GN001A2**

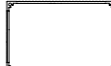

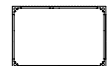
**技术参数 Technology information**

产品型号 Product Code	JB-GN001A1	JB-GN001B1	JB-GN001C1	JB-GN001E1
灯体尺寸 Lamp size	 150 x 100mm	 150 x 75mm	 130 x 85mm	 150 x 60mm
产品高度 Product height	4M-6M	3M-4M	3M-3.5M	3M-4M
功率 Power	30W - 60W	20W / 30W	20W / 30W	20W / 30W
灯体材质 Lamp material	6063 Aluminum material			
色温 Color temp	3000K / 6000K			
灯带颜色 Strip color temp	Blue / Green / Red / Pink / Warm white			
芯片 LED chips	PHILIPS / CREE / BRIGDELUX			
驱动 Power supply	PHILIPS driver / MW driver from taiwan / MOSO®			
透镜角度 Lens angle	120°70°			
效率 Efficiency	87%			
输入电压 Input voltage	AC85-265V			
防护等级 Protection levels	IP65			

# LED Garden Light

## LED 庭院灯

### 产品说明 Product description

#### 材质工艺:

- 灯具设计风格简约时尚、精致典雅、浪漫古典、与城市美化完美结合。
- 灯体采用 6063 铝合金型材制造，灯杆坚韧度高，材料回收率高。
- 灯具光源部分采用高品质 LED 芯片及电源，灯体侧面发光部分则配用 LED 灯带结合：红光、蓝光、绿光、黄光、白光及 RGB 七彩变色。
- 灯体外部采用纳米多功能涂层、防粘贴、防涂鸦、防刮痕。
- 灯具应用场所：公园、商业区、高档别墅庭院、停车场、广场、道路行人道等。

#### Material and Technology:

- The product design creating is concise and fashion/delicate and elegant/classics and romantic/perfect combination and city beautification.
- The lamp body using for 6063 aluminum material, the lamp pole is high tenacity and metal material will be high reclaim.
- The light source with high quality LED chips and power supply, the lamp pole two side with LED strip for color:red/blue/green/yellow/white and RGB full color change.
- The lamp pole with Nano multi-functional coating/prevent paste/prevent scrawl/prevent scratching.
- The lamp application places: public garden/bussiness area/luxury villa garden/ park/plaza/pavements of road .etc.

### 配光曲线 Light Distribution Curve

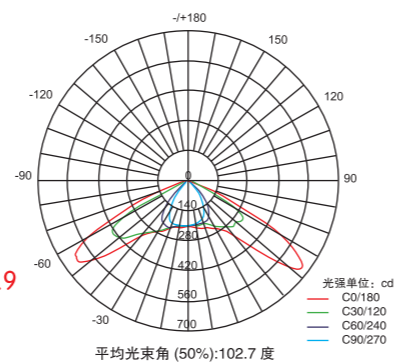

### 技术参数 Technology information

产品型号 Product Code	JB-GN002A1	JB-GN002B1	JB-GN002C1	JB-GN002E1
灯体尺寸 Lamp size	 150 × 100mm	 150 × 75mm	 130 × 85mm	 150 × 60mm
产品高度 Product height	4M-6M	3M-4M	3M-3.5M	3M-4M
功率 Power	30W - 60W	20W / 30W	20W / 30W	20W / 30W
灯体材质 Lamp material	6063 Aluminum material			
色温 Color temp	3000K / 6000K			
灯带颜色 Strip color temp	Blue / Green / Red / Pink / Warm white			
芯片 LED chips	PHILIPS / CREE / BRIGDELUX			
驱动 Power supply	PHILIPS driver / MW driver from taiwan / MOSO®			
透镜角度 Lens angle	120°70°			
效率 Efficiency	87%			
输入电压 Input voltage	AC85-265V			
防护等级 Protection levels	IP65			

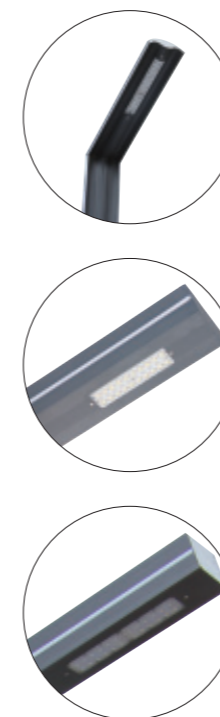

JB-GN002E1

JB-GN002B1

JB-GN002A1

专利号: 201630614653.9



CE FC RoHS  
最受欢迎照明运营商



JB-GN002E1

产品说明 Product description

材质工艺:

- 灯具设计风格简约时尚、精致典雅、浪漫古典、与城市美化完美结合。
- 灯体采用 6063 铝合金型材制造，灯杆坚韧度高，材料回收率高。
- 灯具光源部分采用高品质 LED 芯片及电源，灯体侧面发光部分则配用 LED 灯带结合：红光、蓝光、绿光、黄光、白光及 RGB 七彩变色。
- 灯体外部采用纳米多功能涂层、防粘贴、防涂鸦、防刮痕。
- 灯具应用场所：公园、商业区、高档别墅庭院、停车场、广场、道路行人道等。

Material and Technology:

- The product design creating is concise and fashion/delicate and elegant/classics and romantic/perfect combination and city beautification.
- The lamp body using for 6063 aluminum material,the lamp pole is high tenacity and metal material will be high reclaim.
- The light source with high quality LED chips and power supply,the lamp pole two side with LED strip for color:red/blue/green/yellow/white and RGB full color change.
- The lamp pole with Nano multi-fanctional coating/prevent paste/prevent scrawl/prevent scratching.
- The lamp application places:public garden/bussiness area/luxury villa garden/ park/plaza/pavements of road ,etc.

配光曲线 Light Distribution Curve

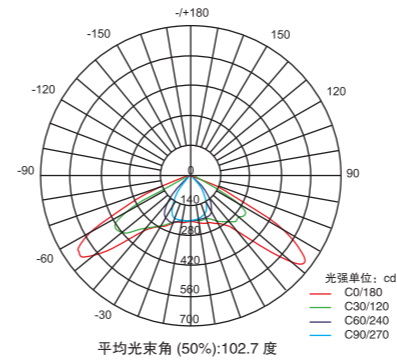

技术参数 Technology information

产品型号 Product Code	JB-GN002A2	JB-GN002C2	JB-GN002A3	JB-GN002C3
灯体尺寸 Lamp size	 150 x 100mm	 130 x 85mm	 150 x 100mm	 130 x 85mm
产品高度 Product height	4M-6M	3M-3.5M	4M-6M	3M-3.5M
功率 Power	30W+10W-60W+20W	20W+10W/30W+10W	2 x 30W-2 x 60W	2 x 20W/2 x 30W
灯体材质 Lamp material	6063 Aluminum material			
色温 Color temp	3000K / 6000K			
灯带颜色 Strip color temp	Blue / Green / Red / Pink / Warm white			
芯片 LED chips	PHILIPS / CREE / BRIGDELUX			
驱动 Power supply	PHILIPS driver / MW driver from taiwan / MOSO®			
透镜角度 Lens angle	120°70°			
效率 Efficiency	87%			
输入电压 Input voltage	AC85-265V			
防护等级 Protection levels	IP65			

JB-GN002A2  
专利号: 201630614651.X

JB-GN002C3  
专利号: 201630614801.7

# LED Garden Light LED 庭院灯

## 产品说明 Product description

### 材质工艺:

- 灯具设计风格简约时尚、精致典雅、浪漫古典、与城市美化完美结合。
- 灯体采用 6063 铝合金型材制造，灯杆坚韧度高，材料回收率高。
- 灯具光源部分采用高品质 LED 芯片及电源，灯体侧面发光部分则配用 LED 灯带结合：红光、蓝光、绿光、黄光、白光及 RGB 七彩变色。
- 灯体外部采用纳米多功能涂层、防粘贴、防涂鸦、防刮痕。
- 灯具应用场所：公园、商业区、高档别墅庭院、停车场、广场、道路行人道等。

### Material and Technology:

- The product design creating is concise and fashion/delicate and elegant/classics and romantic/perfect combination and city beautification.
- The lamp body using for 6063 aluminum material, the lamp pole is high tenacity and metal material will be high reclaim.
- The light source with high quality LED chips and power supply, the lamp pole two side with LED strip for color: red/blue/green/yellow/white and RGB full color change.
- The lamp pole with Nano multi-functional coating/prevent paste/prevent scrawl/prevent scratching.
- The lamp application places: public garden/bussiness area/luxury villa garden/ park/plaza/pavements of road ,etc.

## 配光曲线 Light Distribution Curve

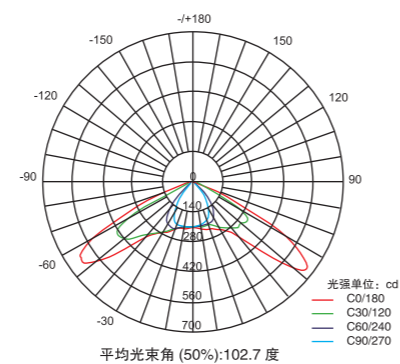

JB-GN12612

JB-GN12611



专利号: 201630614655.8

JB-GN00111

专利号: 201630614802.1



## 技术参数 Technology information

产品型号 Product Code	JB-GN00111	JB-GN12611	JB-GN12612
灯体尺寸 Lamp size	 230 × 80mm	 230 × 80mm	 230 × 80mm
产品高度 Product height	3M-4M	3M-4M	3M-4M
功率 Power	30W	30W	30W
灯体材质 Lamp material	6063 Aluminum material		
色温 Color temp	3000K / 6000K		
灯带颜色 Strip color temp	Blue / Green / Red / Pink / Warm white		
芯片 LED chips	PHILIPS / CREE / BRIGDELUX		
透镜角度 Lens angle	120°70°		
效率 Efficiency	87%		
防护等级 Protection levels	IP65		



# LED Garden Light

## LED 庭院灯

### 产品说明 Product description

#### 材质工艺:

- 灯具设计风格简约时尚、精致典雅、浪漫古典、与城市美化完美结合。
- 灯体采用 6063 铝合金型材制造，灯杆坚韧度高，材料回收率高。
- 灯具光源部分采用高品质 LED 芯片及电源，灯体侧面发光部分则配用 LED 灯带结合：红光、蓝光、绿光、黄光、白光及 RGB 七彩变色。
- 灯体外部采用纳米多功能涂层、防粘贴、防涂鸦、防刮痕。
- 灯具应用场所：公园、商业区、高档别墅庭院、停车场、广场、道路行人道等。

#### Material and Technology:

- The product design creating is concise and fashion/delicate and elegant/classics and romantic/perfect combination and city beautification.
- The lamp body using for 6063 aluminum material, the lamp pole is high tenacity and metal material will be high reclaim.
- The light source with high quality LED chips and power supply, the lamp pole two side with LED strip for color:red/blue/green/yellow/white and RGB full color change.
- The lamp pole with Nano multi-functional coating/prevent paste/prevent scrawl/prevent scratching.
- The lamp application places:public garden/bussiness area/luxury villa garden/ park/plaza/pavements of road .etc.

### 配光曲线 Light Distribution Curve

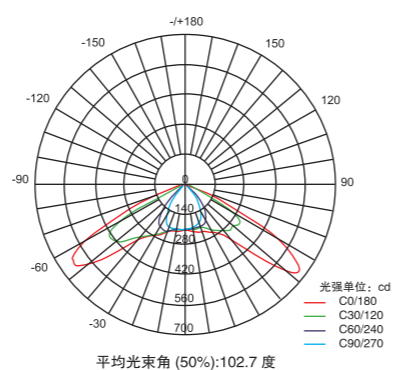

### 技术参数 Technology information

产品型号 Product Code	JB-GN010A1	JB-GN010C1
灯体尺寸 Lamp size	 150 × 100mm	 130 × 85mm
产品高度 Product height	4M-6M	3M-4M
功率 Power	2 × 30W - 2 × 60W	2 × 20W / 2 × 30W
灯体材质 Lamp material	6063 Aluminum material	
色温 Color temp	3000K / 6000K	
灯带颜色 Strip color temp	Blue / Green / Red / Pink / Warm white	
芯片 LED chips	PHILIPS / CREE / BRIGDELUX	
驱动 Power supply	PHILIPS driver / MW driver from taiwan / MOSO®	
透镜角度 Lens angle	120°/70°	
效率 Efficiency	87%	
输入电压 Input voltage	AC85-265V	
防护等级 Protection levels	IP65	





JB-GN003B1

产品说明 Product description

材质工艺:

- 灯具设计风格简约时尚、精致典雅、浪漫古典、与城市美化完美结合。
- 灯体采用 6063 铝合金型材制造,灯杆坚韧度高,材料回收率高。
- 灯具光源部分采用高品质 LED 芯片及电源,灯体侧面发光部分则配用 LED 灯带结合:红光、蓝光、绿光、黄光、白光及 RGB 七彩变色。
- 灯体外部采用纳米多功能涂层、防粘贴、防涂鸦、防刮痕。
- 灯具应用场所:公园、商业区、高档别墅庭院、停车场、广场、道路行人道等。

Material and Technology:

- The product design creating is concise and fashion/delicate and elegant/classics and romantic/perfect combination and city beautification.
- The lamp body using for 6063 aluminum material,the lamp pole is high tenacity and metal material will be high reclaim.
- The light source with high quality LED chips and power supply,the lamp pole two side with LED strip for color:red/blue/green/yellow/white and RGB full color change.
- The lamp pole with Nano multi-fanctional coating/prevent paste/prevent scrawl/prevent scratching.
- The lamp application places:public garden/bussiness area/luxury villa garden/ park/plaza/pavements of road ,etc.

配光曲线 Light Distribution Curve

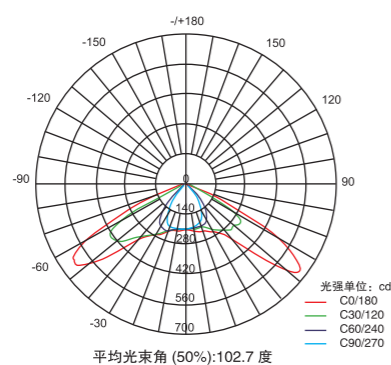

JB-GN003EY2

专利号: 201630614654.3



JB-GN003E1



技术参数 Technology information

产品型号 Product Code	JB-GN003A1	JB-GN003B1	JB-GN003C1	JB-GN003E1	JB-GN003EY2
灯体尺寸 Lamp size	150 x 100mm	150 x 75mm	130 x 85mm	150 x 60mm	150 x 60mm + Φ89mm
产品高度 Product height	4M-6M	3M-4M	3M-4M	3M-4M	3M-4M
功率 Power	30W+10W 60W+20W	20W+10W / 30W+10W	30W+10W	20W-40W	20W+7W 30W+7W
灯体材质 Lamp material	6063 Aluminum material				
色温 Color temp	3000K / 6000K				
灯带颜色 Strip color temp	Blue / Green / Red / Pink / Warm white				
芯片 LED chips	PHILIPS / CREE / BRIGDELUX				
驱动 Power supply	PHILIPS driver / MW driver from taiwan / MOSO®				
透镜角度 Lens angle	120°70°				
效率 Efficiency	87%				
输入电压 Input voltage	AC85-265V				
防护等级 Protection levels	IP65				

# LED Garden Light

## LED 庭院灯

### 产品说明 Product description

#### 材质工艺:

- 灯具设计风格简约时尚、精致典雅、浪漫古典、与城市美化完美结合。
- 灯体采用 6063 铝合金型材制造，灯杆坚韧度高，材料回收率高。
- 灯具光源部分采用高品质 LED 芯片及电源，灯体侧面发光部分则配用 LED 灯带结合：红光、蓝光、绿光、黄光、白光及 RGB 七彩变色。
- 灯体外部采用纳米多功能涂层、防粘贴、防涂鸦、防刮痕。
- 灯具应用场所：公园、商业区、高档别墅庭院、停车场、广场、道路人行道等。

#### Material and Technology:

- The product design creating is concise and fashion/delicate and elegant/classics and romantic/perfect combination and city beautification.
- The lamp body using for 6063 aluminum material,the lamp pole is high tenacity and metal material will be high reclaim.
- The light source with high quality LED chips and power supply,the lamp pole two side with LED strip for color:red/blue/green/yellow/white and RGB full color change.
- The lamp pole with Nano multi-fanctional coating/prevent paste/prevent scrawl/prevent scratching.
- The lamp application places:public garden/bussiness area/luxury villa garden/ park/plaza/pavements of road ,etc.

### 配光曲线 Light Distribution Curve

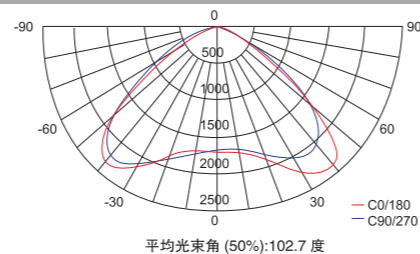

**JB-GN12911**  
专利号: 201630614720.7

**JB-GN005A1**

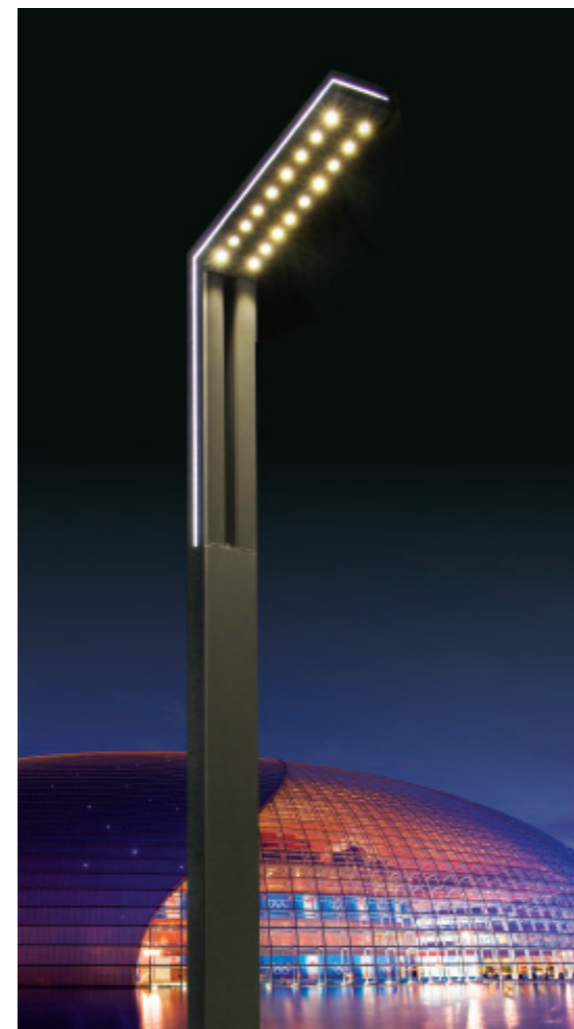

### 技术参数 Technology information

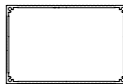
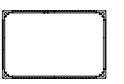
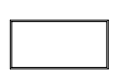
产品型号 Product Code	JB-GN005A1	JB-GN005C1	JB-GN12911
灯体尺寸 Lamp size	 150 x 100mm	 130 x 85mm	 200 x 100mm
产品高度 Product height	4M-6M	3M-3.5M	3M-4M
功率 Power	40W	40W	36W
灯体材质 Lamp material	6063 Aluminum material		
色温 Color temp	3000K / 6000K		
灯带颜色 Strip color temp	Blue / Green / Red / Pink / Warm white		
芯片 LED chips	PHILIPS / CREE / BRIGDELUX		
驱动 Power supply	PHILIPS driver / MW driver from taiwan / MOSO®		
透镜角度 Lens angle	120°70°		
效率 Efficiency	87%		
输入电压 Input voltage	AC85-265V		
防护等级 Protection levels	IP65		

# LED Garden Light LED 庭院灯

## 产品说明 Product description

### 材质工艺:

- 灯具设计风格简约时尚、精致典雅、浪漫古典、与城市美化完美结合。
- 灯体采用 6063 铝合金型材制造，灯杆坚韧度高，材料回收率高。
- 灯具光源部分采用高品质 LED 芯片及电源，灯体侧面发光部分则配用 LED 灯带结合：红光、蓝光、绿光、黄光、白光及 RGB 七彩变色。
- 灯体外部采用纳米多功能涂层、防粘贴、防涂鸦、防刮痕。
- 灯具应用场所：公园、商业区、高档别墅庭院、停车场、广场、道路行人道等。

### Material and Technology:

- The product design creating is concise and fashion/delicate and elegant/classics and romantic/perfect combination and city beautification.
- The lamp body using for 6063 aluminum material,the lamp pole is high tenacity and metal material will be high reclaim.
- The light source with high quality LED chips and power supply,the lamp pole two side with LED strip for color:red/blue/green/yellow/white and RGB full color change.
- The lamp pole with Nano multi-functional coating/prevent paste/prevent scrawl/prevent scratching.
- The lamp application places:public garden/business area/luxury villa garden/ park/plaza/pavements of road ,etc.

## 配光曲线 Light Distribution Curve

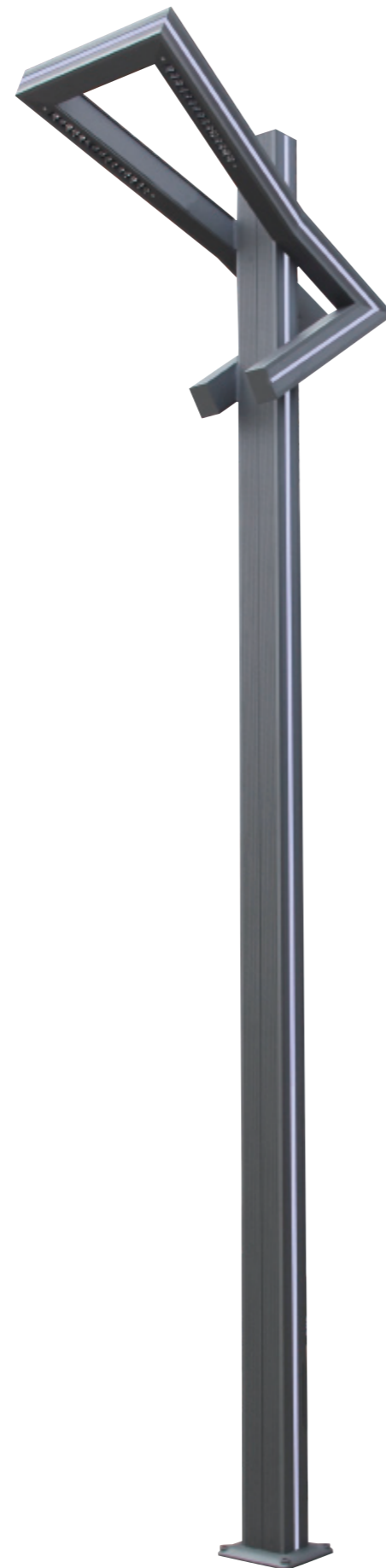
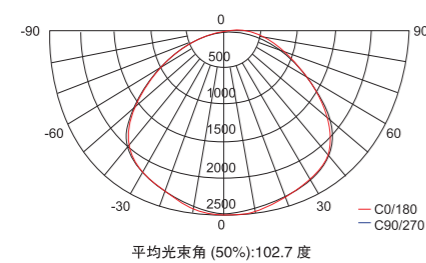

**JB-GN004**  
专利号: 201630614804.0



## 技术参数 Technology information

产品型号 Product Code	JB-GN004A1	JB-GN004C1
灯体尺寸 Lamp size	 150 × 100mm	 130 × 85mm
产品高度 Product height	4M-6M	3M-3.5M
功率 Power	30W-40W	30W-40W
灯体材质 Lamp material	6063 Aluminum material	
色温 Color temp	3000K / 6000K	
灯带颜色 Strip color temp	Blue / Green / Red / Pink / Warm white	
芯片 LED chips	PHILIPS / CREE / BRIGDELUX	
驱动 Power supply	PHILIPS driver / MW driver from taiwan / MOSO®	
透镜角度 Lens angle	120°70°	
效率 Efficiency	87%	
输入电压 Input voltage	AC85-265V	
防护等级 Protection levels	IP65	

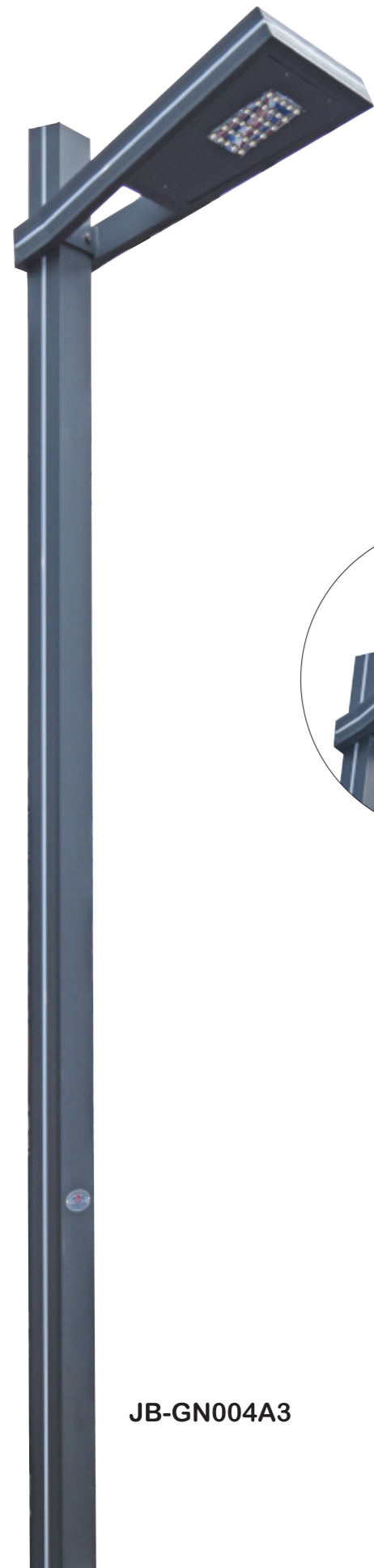

JB-GN004A3

# LED Garden Light

## LED 庭院灯

### 产品说明 Product description

#### 材质工艺:

- 灯具设计风格简约时尚、精致典雅、浪漫古典、与城市美化完美结合。
- 灯体采用 6063 铝合金型材制造，灯杆坚韧度高，材料回收率高。
- 灯具光源部分采用高品质 LED 芯片及电源，灯体侧面发光部分则配用 LED 灯带结合：红光、蓝光、绿光、黄光、白光及 RGB 七彩变色。
- 灯体外部采用纳米多功能涂层、防粘贴、防涂鸦、防刮痕。
- 灯具应用场所：公园、商业区、高档别墅庭院、停车场、广场、道路行人道等。

#### Material and Technology:

- The product design creating is concise and fashion/delicate and elegant/classics and romantic/perfect combination and city beautification.
- The lamp body using for 6063 aluminum material, the lamp pole is high tenacity and metal material will be high reclaim.
- The light source with high quality LED chips and power supply, the lamp pole two side with LED strip for color: red/blue/green/yellow/white and RGB full color change.
- The lamp pole with Nano multi-functional coating/prevent paste/prevent scrawl/prevent scratching.
- The lamp application places: public garden/bussiness area/luxury villa garden/ park/plaza/pavements of road .etc.

### 配光曲线 Light Distribution Curve

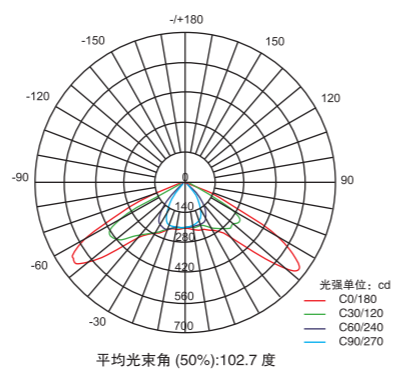

### 技术参数 Technology information

产品型号 Product Code	JB-GN004A3	JB-GN004C3
灯体尺寸 Lamp size	 150 × 100mm	 130 × 85mm
产品高度 Product height	4M-6M	3M-4M
功率 Power	30W-40W	30W-40W
灯体材质 Lamp material	6063 Aluminum material	
色温 Color temp	3000K / 6000K	
灯带颜色 Strip color temp	Blue / Green / Red / Pink / Warm white	
芯片 LED chips	PHILIPS / CREE / BRIGDELUX	
驱动 Power supply	PHILIPS driver / MW driver from taiwan / MOSO®	
透镜角度 Lens angle	120°70°	
效率 Efficiency	87%	
输入电压 Input voltage	AC85-265V	
防护等级 Protection levels	IP65	

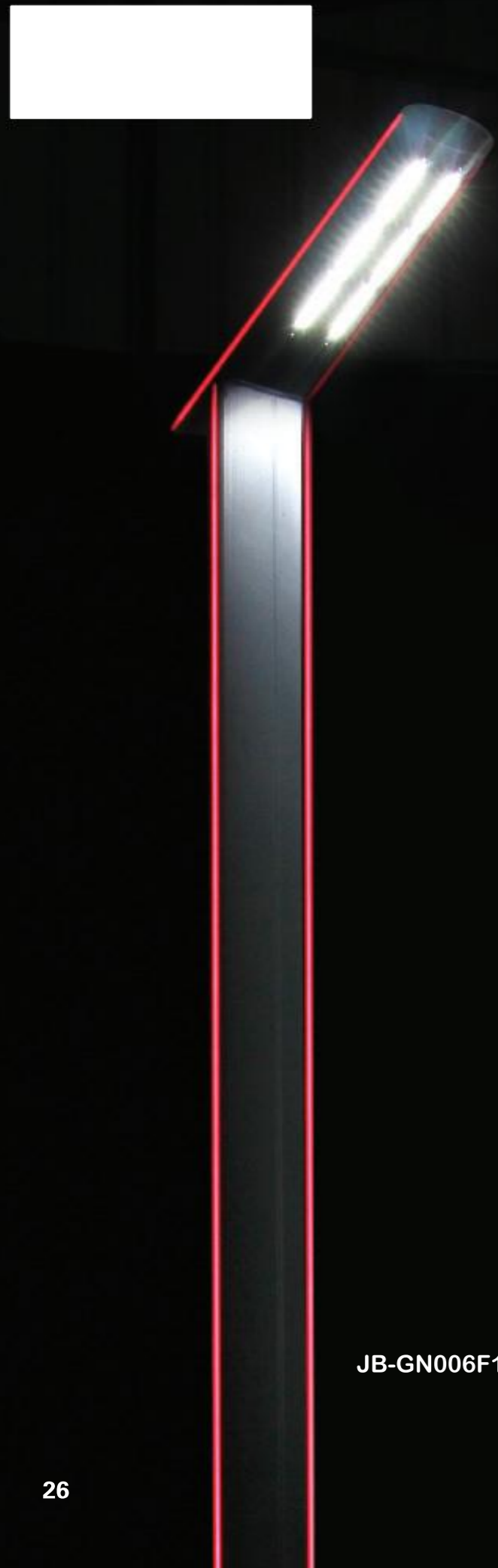

JB-GN006F1

# LED Garden Light

## LED 庭院灯

### 产品说明 Product description

#### 材质工艺:

- 灯具设计风格简约时尚、精致典雅、浪漫古典、与城市美化完美结合。
- 灯体采用 6063 铝合金型材制造，灯杆坚韧度高，材料回收率高。
- 灯具光源部分采用高品质 LED 芯片及电源，灯体侧面发光部分则配用 LED 灯带结合：红光、蓝光、绿光、黄光、白光及 RGB 七彩变色。
- 灯体外部采用纳米多功能涂层、防粘贴、防涂鸦、防刮痕。
- 灯具应用场所：公园、商业区、高档别墅庭院、停车场、广场、道路行人道等。

#### Material and Technology:

- The product design creating is concise and fashion/delicate and elegant/classics and romantic/perfect combination and city beautification.
- The lamp body using for 6063 aluminum material, the lamp pole is high tenacity and metal material will be high reclaim.
- The light source with high quality LED chips and power supply, the lamp pole two side with LED strip for color:red/blue/green/yellow/white and RGB full color change.
- The lamp pole with Nano multi-functional coating/prevent paste/prevent scrawl/prevent scratching.
- The lamp application places: public garden/business area/luxury villa garden/ park/plaza/pavements of road ,etc.

### 配光曲线 Light Distribution Curve

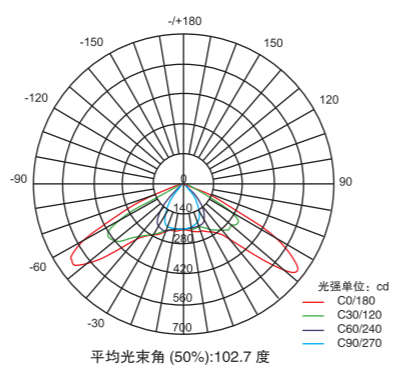

### 技术参数 Technology information

产品型号 Product Code	JB-GN006F1
灯体尺寸 Lamp size	 200 x 100mm
产品高度 Product height	3M-4M
功率 Power	30W
灯体材质 Lamp material	6063 Aluminum material
色温 Color temp	3000K / 6000K
灯带颜色 Strip color temp	Blue / Green / Red / Pink / Warm white
芯片 LED chips	PHILIPS / CREE / BRIGDELUX
驱动 Power supply	PHILIPS driver / MW driver from taiwan / MOSO®
透镜角度 Lens angle	120°70°
效率 Efficiency	87%
输入电压 Input voltage	AC85-265V
防护等级 Protection levels	IP65



# LED Garden Light

## LED 庭院灯

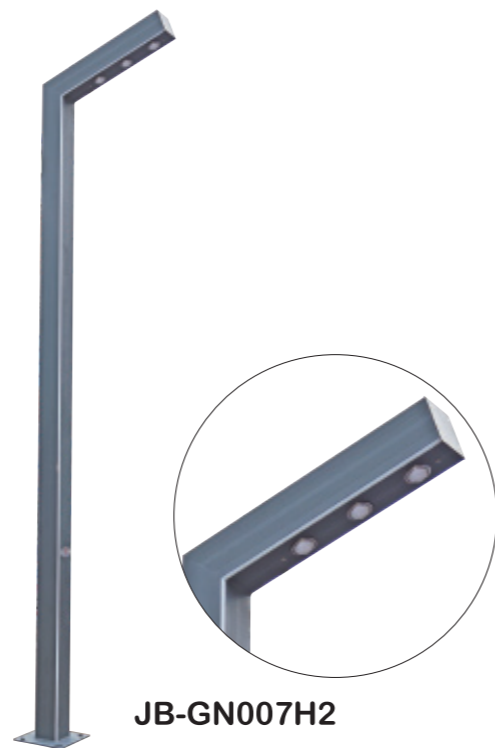

JB-GN007H2

### 产品说明 Product description

#### 材质工艺:

- 灯具设计风格简约时尚、精致典雅、浪漫古典、与城市美化完美结合。
- 灯体采用 6063 铝合金型材制造，灯杆坚韧度高，材料回收率高。
- 灯具光源部分采用高品质 LED 芯片及电源，灯体侧面发光部分则选用 LED 灯带结合：红光、蓝光、绿光、黄光、白光及 RGB 七彩变色。
- 灯体外部采用纳米多功能涂层、防粘贴、防涂鸦、防刮痕。
- 灯具应用场所：公园、商业区、高档别墅庭院、停车场、广场、道路行人道等。

#### Material and Technology:

- The product design creating is concise and fashion/delicate and elegant/classics and romantic/perfect combination and city beautification.
- The lamp body using for 6063 aluminum material, the lamp pole is high tenacity and metal material will be high reclaim.
- The light source with high quality LED chips and power supply, the lamp pole two side with LED strip for color: red/blue/green/yellow/white and RGB full color change.
- The lamp pole with Nano multi-functional coating/prevent paste/prevent scrawl/prevent scratching.
- The lamp application places: public garden/business area/luxury villa garden/ park/plaza/pavements of road ,etc.

### 配光曲线 Light Distribution Curve

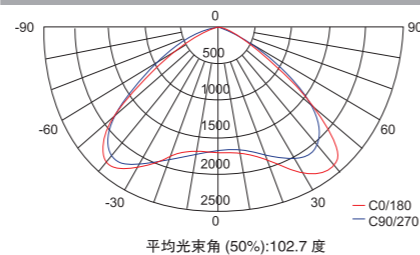

JB-GN007H1  
专利号: 201630614556.X

### 技术参数 Technology information

产品型号 Product Code	JB-GN007G1	JB-GN007G2	JB-GN007H1	JB-GN007H2
灯体尺寸 Lamp size	 120 x 120mm	 120 x 120mm	 100 x 100mm	 100 x 100mm
产品高度 Product height	4M-6M	4M-6M	3M-4M	3M-4M
功率 Power	30W - 60W	30W - 60W	20W / 30W	20W / 30W
灯体材质 Lamp material	6063 Aluminum material			
色温 Color temp	3000K / 6000K			
灯带颜色 Strip color temp	Blue / Green / Red / Pink / Warm white			
芯片 LED chips	PHILIPS / CREE / BRIGDELUX			
驱动 Power supply	PHILIPS driver / MW driver from taiwan / MOSO®			
透镜角度 Lens angle	120°70°			
效率 Efficiency	87%			
输入电压 Input voltage	AC85-265V			
防护等级 Protection levels	IP65			

# LED Garden Light LED 庭院灯



## 产品说明 Product description

### 材质工艺:

- 灯具设计风格简约时尚、精致典雅、浪漫古典、与城市美化完美结合。
- 灯体采用 6063 铝合金型材制造，灯杆坚韧度高，材料回收率高。
- 灯具光源部分采用高品质 LED 芯片及电源，灯体侧面发光部分则配用 LED 灯带结合：红光、蓝光、绿光、黄光、白光及 RGB 七彩变色。
- 灯体外部采用纳米多功能涂层、防粘贴、防涂鸦、防刮痕。
- 灯具应用场所：公园、商业区、高档别墅庭院、停车场、广场、道路行人道等。

### Material and Technology:

- The product design creating is concise and fashion/delicate and elegant/classics and romantic/perfect combination and city beautification.
- The lamp body using for 6063 aluminum material,the lamp pole is high tenacity and metal material will be high reclaim.
- The light source with high quality LED chips and power supply,the lamp pole two side with LED strip for color:red/blue/green/yellow/white and RGB full color change.
- The lamp pole with Nano multi-fanctional coating/prevent paste/prevent scrawl/prevent scratching.
- The lamp application places:public garden/bussiness area/luxury villa garden/ park/plaza/pavements of road ,etc.

## 配光曲线 Light Distribution Curve

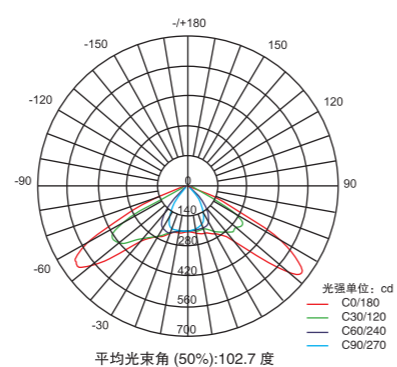

JB-GN008G1

专利号: 201730215716.8



## 技术参数 Technology information

产品型号 Product Code	JB-GN008G1	JB-GN008H1
灯体尺寸 Lamp size	 120 × 120mm	 100 × 100mm
产品高度 Product height	4M-6M	3M-4M
功率 Power	30W - 60W	20W / 30W
灯体材质 Lamp material	6063 Aluminum material	
色温 Color temp	3000K / 6000K	
灯带颜色 Strip color temp	Blue / Green / Red / Pink / Warm white	
芯片 LED chips	PHILIPS / CREE / BRIGDELUX	
驱动 Power supply	PHILIPS driver / MW driver from taiwan / MOSO®	
透镜角度 Lens angle	120°70°	
效率 Efficiency	87%	
输入电压 Input voltage	AC85-265V	
防护等级 Protection levels	IP65	

# LED Garden Light

## LED 庭院灯

### 产品说明 Product description

#### 材质工艺:

- 灯具设计风格简约时尚、精致典雅、浪漫古典、与城市美化完美结合。
- 灯体采用 6063 铝合金型材制造，灯杆坚韧度高，材料回收率高。
- 灯具光源部分采用高品质 LED 芯片及电源，灯体侧面发光部分则配用 LED 灯带结合：红光、蓝光、绿光、黄光、白光及 RGB 七彩变色。
- 灯体外部采用纳米多功能涂层、防粘贴、防涂鸦、防刮痕。
- 灯具应用场所：公园、商业区、高档别墅庭院、停车场、广场、道路行人道等。

#### Material and Technology:

- The product design creating is concise and fashion/delicate and elegant/classics and romantic/perfect combination and city beautification.
- The lamp body using for 6063 aluminum material,the lamp pole is high tenacity and metal material will be high reclaim.
- The light source with high quality LED chips and power supply,the lamp pole two side with LED strip for color:red/blue/green/yellow/white and RGB full color change.
- The lamp pole with Nano multi-functional coating/prevent paste/prevent scrawl/prevent scratching.
- The lamp application places:public garden/bussiness area/luxury villa garden/ park/plaza/pavements of road ,etc.

### 配光曲线 Light Distribution Curve

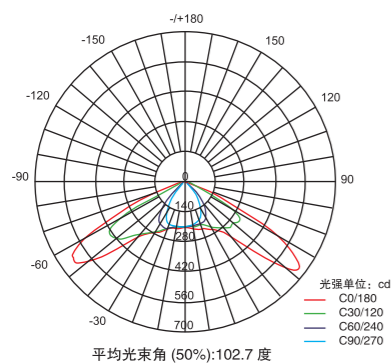

JB-GN009D1

专利号: 201730215704.5



### 技术参数 Technology information

产品型号 Product Code	JB-GN009D1
灯体尺寸 Lamp size	 130 x 130 x 130mm
产品高度 Product height	3M-4M
功率 Power	30W
灯体材质 Lamp material	6063 Aluminum material
色温 Color temp	3000K / 6000K
灯带颜色 Strip color temp	Blue / Green / Red / Pink / Warm white
芯片 LED chips	PHILIPS / CREE / BRIGDELUX
驱动 Power supply	PHILIPS driver / MW driver from taiwan / MOSO®
透镜角度 Lens angle	120°70°
效率 Efficiency	87%
输入电压 Input voltage	AC85-265V
防护等级 Protection levels	IP65



# LED Garden Light LED 庭院灯

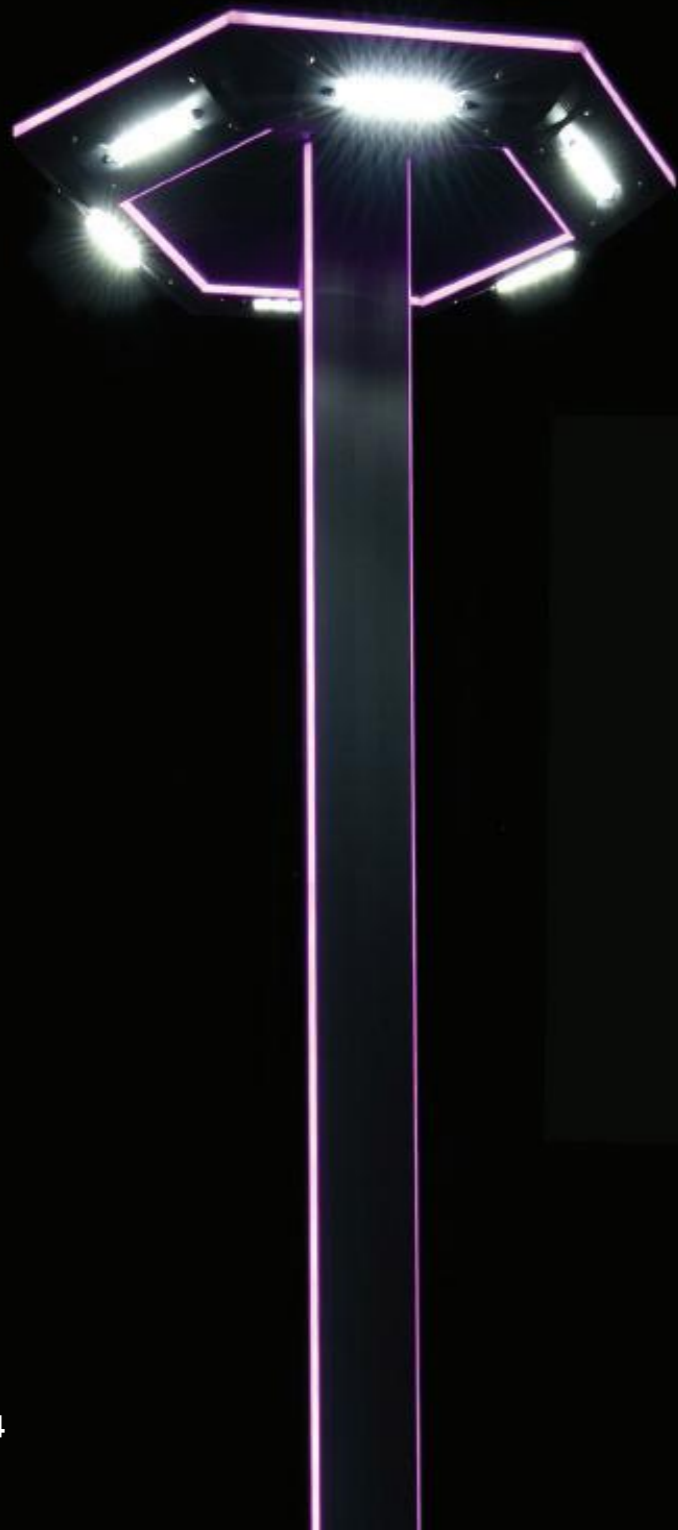

## 产品说明 Product description

### 材质工艺:

- 灯具设计风格简约时尚、精致典雅、浪漫古典、与城市美化完美结合。
- 灯体采用 6063 铝合金型材制造，灯杆坚韧度高，材料回收率高。
- 灯具光源部分采用高品质 LED 芯片及电源，灯体侧面发光部分则选用 LED 灯带结合：红光、蓝光、绿光、黄光、白光及 RGB 七彩变色。
- 灯体外部采用纳米多功能涂层、防粘贴、防涂鸦、防刮痕。
- 灯具应用场所：公园、商业区、高档别墅庭院、停车场、广场、道路行人道等。

### Material and Technology:

- The product design creating is concise and fashion/delicate and elegant/classics and romantic/perfect combination and city beautification.
- The lamp body using for 6063 aluminum material, the lamp pole is high tenacity and metal material will be high reclaim.
- The light source with high quality LED chips and power supply, the lamp pole two side with LED strip for color:red/blue/green/yellow/white and RGB full color change.
- The lamp pole with Nano multi-functional coating/prevent paste/prevent scrawl/prevent scratching.
- The lamp application places:public garden/bussiness area/luxury villa garden/ park/plaza/pavements of road .etc.

## 配光曲线 Light Distribution Curve

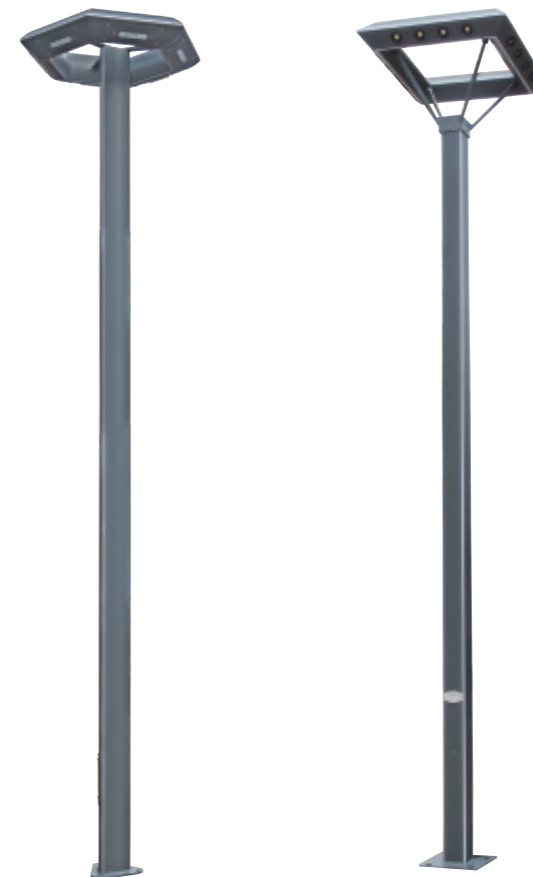
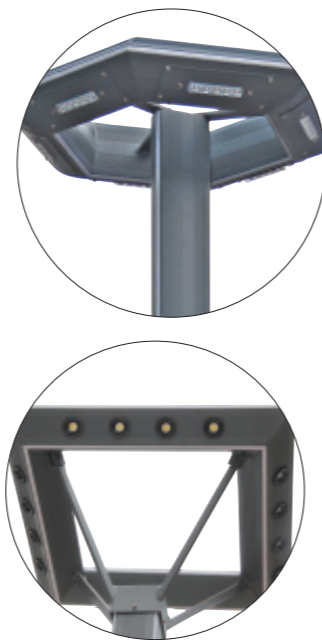
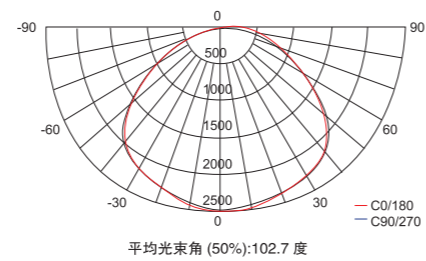

JB-GN117D1

JB-GN118H1

专利号: 201730215694.5

## LED 庭院灯系列 | LED GARDEN LIGHT SERIES



## 技术参数 Technology information

产品型号 Product Code	JB-GN117D1	JB-GN118H1
灯体尺寸 Lamp size	 130 × 130 × 130mm	 120 × 120mm
产品高度 Product height	3M-4M	3M-4M
功率 Power	30W	48W
灯体材质 Lamp material	6063 Aluminum material	
色温 Color temp	3000K / 6000K	
灯带颜色 Strip color temp	Blue / Green / Red / Pink / Warm white	
芯片 LED chips	PHILIPS / CREE / BRIGDELUX	
驱动 Power supply	PHILIPS driver / MW driver from taiwan / MOSO®	
透镜角度 Lens angle	120°70°	
效率 Efficiency	87%	
输入电压 Input voltage	AC85-265V	
防护等级 Protection levels	IP65	

# LED Garden Light

## LED 庭院灯



**JB-GN119A2**  
专利号: 201730215693.0



### 产品说明 Product description

#### 材质工艺:

- 灯具设计风格简约时尚、精致典雅、浪漫古典、与城市美化完美结合。
- 灯体采用 6063 铝合金型材制造，灯杆坚韧度高，材料回收率高。
- 灯具光源部分采用高品质 LED 芯片及电源，灯体侧面发光部分则配备 LED 灯带结合：红光、蓝光、绿光、黄光、白光及 RGB 七彩变色。
- 灯体外部采用纳米多功能涂层、防粘贴、防涂鸦、防刮痕。
- 灯具应用场所：公园、商业区、高档别墅庭院、停车场、广场、道路人行道等。

#### Material and Technology:

- The product design creating is concise and fashion/delicate and elegant/classics and romantic/perfect combination and city beautification.
- The lamp body using for 6063 aluminum material,the lamp pole is high tenacity and metal material will be high reclaim.
- The light source with high quality LED chips and power supply,the lamp pole two side with LED strip for color:red/blue/green/yellow/white and RGB full color change.
- The lamp pole with Nano multi-fancional coating/prevent paste/prevent scrawl/prevent scratching.
- The lamp application places:public garden/bussiness area/luxury villa garden/ park/plaza/pavements of road ,etc.

### 配光曲线 Light Distribution Curve

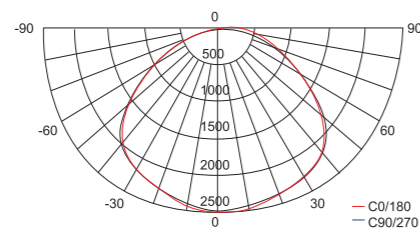

平均光束角 (50%):102.7 度

**JB-GN119C1**  
专利号: 201630614827.1



### 技术参数 Technology information

产品型号 Product Code	JB-GN119A2	JB-GN119C2	JB-GN119A1	JB-GN119C1
灯体尺寸 Lamp size	 150 × 100mm	 130 × 85mm	 150 × 100mm	 130 × 85mm
产品高度 Product height	3M-4M	3M-4M	3M-4M	3M-4M
功率 Power	20W / 30W	20W / 30W	20W / 30W	20W / 30W
灯体材质 Lamp material	6063 Aluminum material			
色温 Color temp	3000K / 6000K			
灯带颜色 Strip color temp	Blue / Green / Red / Pink / Warm white			
芯片 LED chips	PHILIPS / CREE / BRIGDELUX			
驱动 Power supply	PHILIPS driver / MW driver from taiwan / MOSO®			
透镜角度 Lens angle	120°70°			
效率 Efficiency	87%			
输入电压 Input voltage	AC85-265V			
防护等级 Protection levels	IP65			

**产品说明 Product description**

**材质工艺:**

- 灯具设计风格简约时尚、精致典雅、浪漫古典、与城市美化完美结合。
- 灯体采用 6063 铝合金型材制造，灯杆坚韧度高，材料回收率高。
- 灯具光源部分采用高品质 LED 芯片及电源，灯体侧面发光部分则配用 LED 灯带结合：红光、蓝光、绿光、黄光、白光及 RGB 七彩变色。
- 灯体外部采用纳米多功能涂层、防粘贴、防涂鸦、防刮痕。
- 灯具应用场所：公园、商业区、高档别墅庭院、停车场、广场、道路行人道等。

**Material and Technology:**

- The product design creating is concise and fashion/delicate and elegant/classics and romantic/perfect combination and city beautification.
- The lamp body using for 6063 aluminum material,the lamp pole is high tenacity and metal material will be high reclaim.
- The light source with high quality LED chips and power supply,the lamp pole two side with LED strip for color:red/blue/green/yellow/white and RGB full color change.
- The lamp pole with Nano multi-fanctional coating/prevent paste/prevent scrawl/prevent scratching.
- The lamp application places:public garden/bussiness area/luxury villa garden/ park/plaza/pavements of road ,etc.

**配光曲线 Light Distribution Curve**

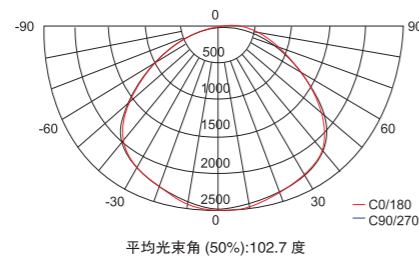

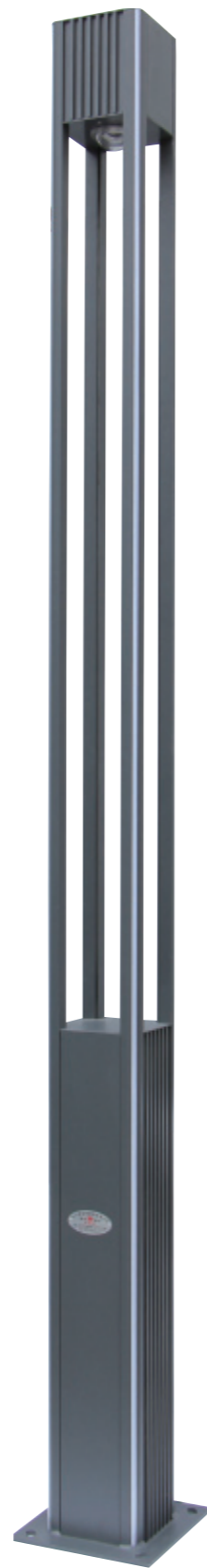

**JB-GN128J1**  
专利号: 201730215688.X



**JB-GN128J2**



**技术参数 Technology information**

产品型号 Product Code	JB-GN128J1	JB-GN128J2
灯体尺寸 Lamp size	 200 × 200mm	 200 × 200mm
产品高度 Product height	3M-6M	3M-6M
功率 Power	20W - 50W	20W / 60W
灯体材质 Lamp material	6063 Aluminum material	
色温 Color temp	3000K / 6000K	
灯带颜色 Strip color temp	Blue / Green / Red / Pink / Warm white	
芯片 LED chips	PHILIPS / CREE / BRIGDELUX	
驱动 Power supply	PHILIPS driver / MW driver from taiwan / MOSO®	
透镜角度 Lens angle	120°70°	
效率 Efficiency	87%	
输入电压 Input voltage	AC85-265V	
防护等级 Protection levels	IP65	

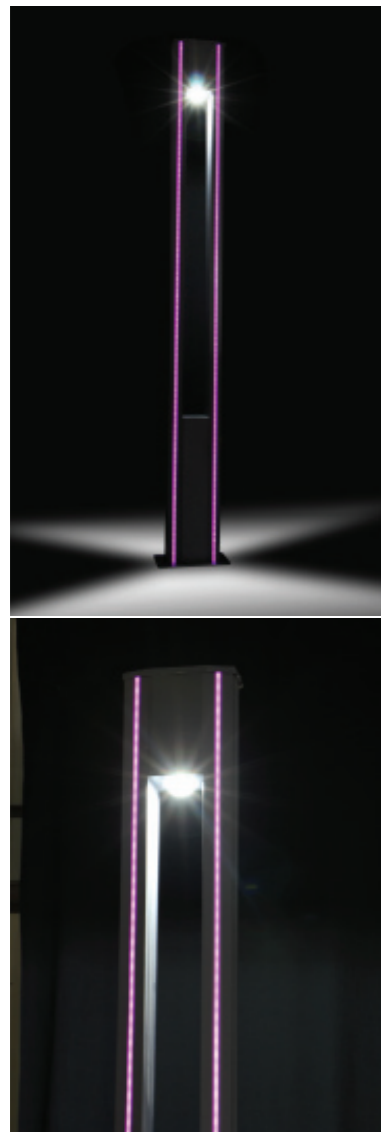

**JB-GN127B1**  
专利号: 201630614805.5

**产品说明 Product description**

**材质工艺:**

- 灯具设计风格简约时尚、精致典雅、浪漫古典、与城市美化完美结合。
- 灯体采用 6063 铝合金型材制造, 灯杆坚韧度高, 材料回收率高。
- 灯具光源部分采用高品质 LED 芯片及电源, 灯体侧面发光部分则配用 LED 灯带结合: 红光、蓝光、绿光、黄光、白光及 RGB 七彩变色。
- 灯体外部采用纳米多功能涂层、防粘贴、防涂鸦、防刮痕。
- 灯具应用场所: 公园、商业区、高档别墅庭院、停车场、广场、道路行人道等。

**Material and Technology:**

- The product design creating is concise and fashion/delicate and elegant/classics and romantic/perfect combination and city beautification.
- The lamp body using for 6063 aluminum material,the lamp pole is high tenacity and metal material will be high reclaim.
- The light source with high quality LED chips and power supply,the lamp pole two side with LED strip for color:red/blue/green/yellow/white and RGB full color change.
- The lamp pole with Nano multi-fanctional coating/prevent paste/prevent scrawl/prevent scratching.
- The lamp application places:public garden/bussiness area/luxury villa garden/ park/plaza/pavements of road ,etc.

**配光曲线 Light Distribution Curve**

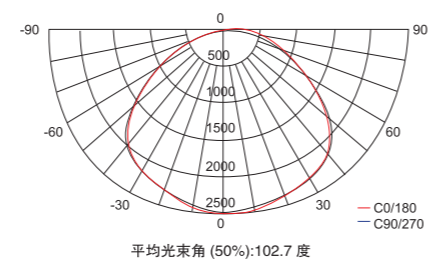

**技术参数 Technology information**

产品型号 Product Code	JB-GN127B1
灯体尺寸 Lamp size	 300 x 150mm
产品高度 Product height	3M-6M
功率 Power	20W - 50W
灯体材质 Lamp material	6063 Aluminum material
色温 Color temp	3000K / 6000K
灯带颜色 Strip color temp	Blue / Green / Red / Pink / Warm white
芯片 LED chips	PHILIPS / CREE / BRIGDELUX
驱动 Power supply	PHILIPS driver / MW driver from taiwan / MOSO®
透镜角度 Lens angle	120°/70°
效率 Efficiency	87%
输入电压 Input voltage	AC85-265V
防护等级 Protection levels	IP65



产品说明 Product description

- 材质工艺:
- 灯具设计风格简约时尚、精致典雅、浪漫古典、与城市美化完美结合。
  - 灯体采用 6063 铝合金型材制造,灯杆坚韧度高,材料回收率高。
  - 灯具光源部分采用高品质 LED 芯片及电源,灯体侧面发光部分则配用 LED 灯带结合:红光、蓝光、绿光、黄光、白光及 RGB 七彩变色。
  - 灯体外部采用纳米多功能涂层、防粘贴、防涂鸦、防刮痕。
  - 灯具应用场所:公园、商业区、高档别墅庭院、停车场、广场、道路行人道等。

Material and Technology:

- The product design creating is concise and fashion/delicate and elegant/classics and romantic/perfect combination and city beautification.
- The lamp body using for 6063 aluminum material,the lamp pole is high tenacity and metal material will be high reclaim.
- The light source with high quality LED chips and power supply,the lamp pole two side with LED strip for color:red/blue/green/yellow/white and RGB full color change.
- The lamp pole with Nano multi-fanctional coating/prevent paste/prevent scrawl/prevent scratching.
- The lamp application places:public garden/bussiness area/luxury villa garden/ park/plaza/pavements of road ,etc.



配光曲线 Light Distribution Curve

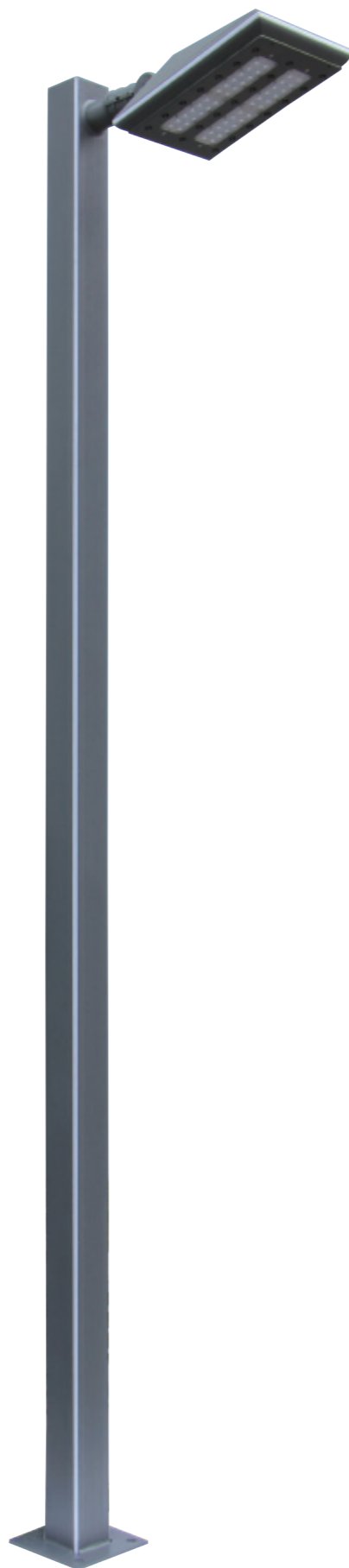
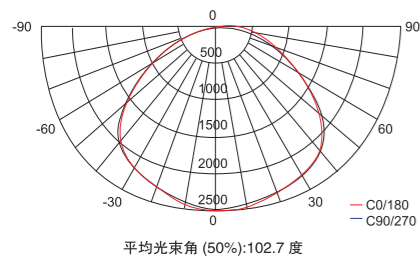

JB-GN8011H1



技术参数 Technology information

产品型号 Product Code	JB-GN8011G1	JB-GN8011H1
灯体尺寸 Lamp size	 120 × 120mm	 100 × 100mm
产品高度 Product height	3M-6M	3M-4M
功率 Power	40W - 80W	40W / 60W
灯体材质 Lamp material	6063 Aluminum material	
色温 Color temp	3000K / 6000K	
灯带颜色 Strip color temp	Blue / Green / Red / Pink / Warm white	
芯片 LED chips	PHILIPS / CREE / BRIGDELUX	
驱动 Power supply	PHILIPS driver / MW driver from taiwan / MOSO®	
透镜角度 Lens angle	120°70°	
效率 Efficiency	87%	
输入电压 Input voltage	AC85-265V	
防护等级 Protection levels	IP65	

# LED Garden Light LED 庭院灯

## 产品说明 Product description

### 材质工艺:

- 灯具设计风格简约时尚、精致典雅、浪漫古典、与城市美化完美结合。
- 灯体采用 6063 铝合金型材制造，灯杆坚韧度高，材料回收率高。
- 灯具光源部分采用高品质 LED 芯片及电源，灯体侧面发光部分则选用 LED 灯带结合：红光、蓝光、绿光、黄光、白光及 RGB 七彩变色。
- 灯体外部采用纳米多功能涂层、防粘贴、防涂鸦、防刮痕。
- 灯具应用场所：公园、商业区、高档别墅庭院、停车场、广场、道路行人道等。

### Material and Technology:

- The product design creating is concise and fashion/delicate and elegant/classics and romantic/perfect combination and city beautification.
- The lamp body using for 6063 aluminum material,the lamp pole is high tenacity and metal material will be high reclaim.
- The light source with high quality LED chips and power supply,the lamp pole two side with LED strip for color:red/blue/green/yellow/white and RGB full color change.
- The lamp pole with Nano multi-functional coating/prevent paste/prevent scrawl/prevent scratching.
- The lamp application places:public garden/business area/luxury villa garden/ park/plaza/pavements of road ,etc.

## 配光曲线 Light Distribution Curve

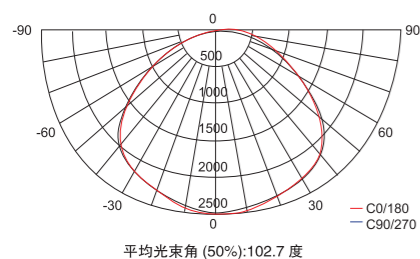

JB-GN103Z3

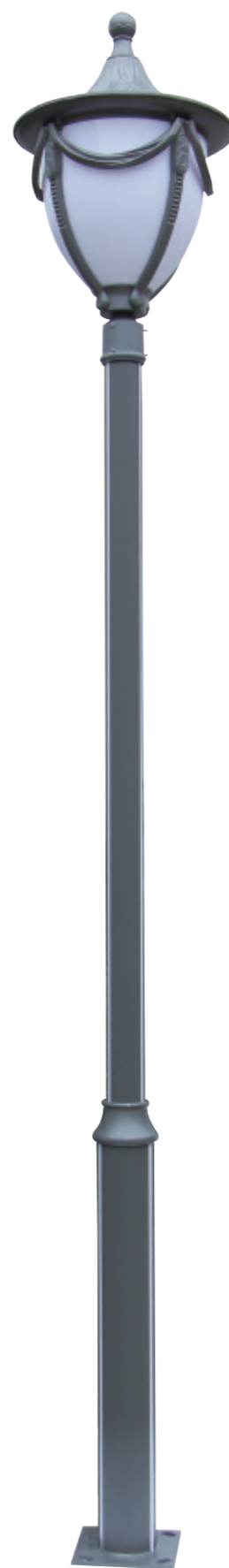

JB-GN103Z25



## 技术参数 Technology information

产品型号 Product Code	JB-GN103Z3		JB-GN103Z25	
灯体尺寸 Lamp size				
产品高度 Product height	3M-3.5M	3.5M-4M	3M-3.5M	3.5M-4M
功率 Power	30W		30W	
灯体材质 Lamp material	6063 Aluminum material			
色温 Color temp	3000K / 6000K			
灯带颜色 Strip color temp	Blue / Green / Red / Pink / Warm white			
芯片 LED chips	PHILIPS / CREE / BRIGDELUX			
驱动 Power supply	PHILIPS driver / MW driver from taiwan / MOSO®			
透镜角度 Lens angle	120°70°			
效率 Efficiency	87%			
输入电压 Input voltage	AC85-265V			
防护等级 Protection levels	IP65			

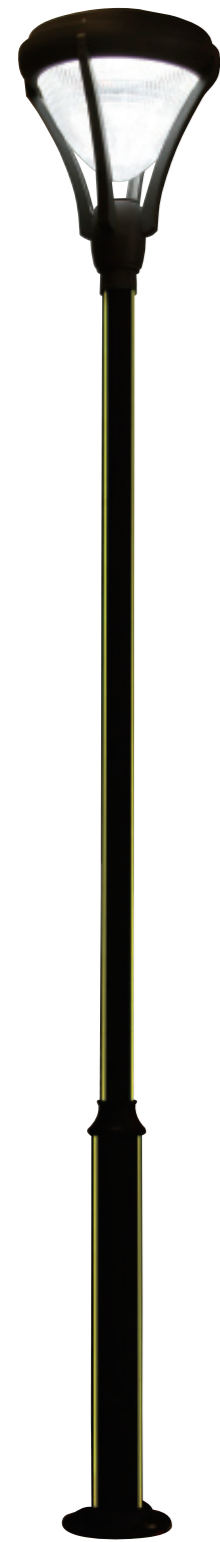

JB-GN103Z5

## LED Garden Light LED 庭院灯

### 产品说明 Product description

#### 材质工艺:

- 灯具设计风格简约时尚、精致典雅、浪漫古典、与城市美化完美结合。
- 灯体采用 6063 铝合金型材制造，灯杆坚韧度高，材料回收率高。
- 灯具光源部分采用高品质 LED 芯片及电源，灯体侧面发光部分则配用 LED 灯带结合：红光、蓝光、绿光、黄光、白光及 RGB 七彩变色。
- 灯体外部采用纳米多功能涂层、防粘贴、防涂鸦、防刮痕。
- 灯具应用场所：公园、商业区、高档别墅庭院、停车场、广场、道路行人道等。

#### Material and Technology:

- The product design creating is concise and fashion/delicate and elegant/classics and romantic/perfect combination and city beautification.
- The lamp body using for 6063 aluminum material, the lamp pole is high tenacity and metal material will be high reclaim.
- The light source with high quality LED chips and power supply, the lamp pole two side with LED strip for color: red/blue/green/yellow/white and RGB full color change.
- The lamp pole with Nano multi-functional coating/prevent paste/prevent scrawl/prevent scratching.
- The lamp application places: public garden/business area/luxury villa garden/ park/plaza/pavements of road , etc.

### 配光曲线 Light Distribution Curve

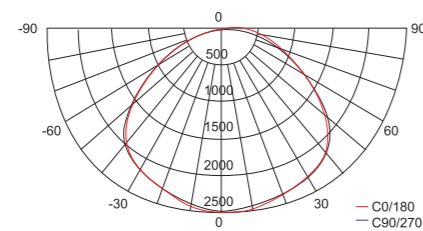

平均光束角 (50%): 102.7 度



JB-GN103Z4



### 技术参数 Technology information

产品型号 Product Code	JB-GN103Z4		JB-GN103Z5	
灯体尺寸 Lamp size				
	Φ114mm+Φ76mm	Φ140mm+Φ89mm	Φ114mm+Φ76mm	Φ140mm+Φ89mm
产品高度 Product height	3M-3.5M	3.5M-4M	3M-3.5M	3.5M-4M
功率 Power	30W		30W	
灯体材质 Lamp material	6063 Aluminum material			
色温 Color temp	3000K / 6000K			
灯带颜色 Strip color temp	Blue / Green / Red / Pink / Warm white			
芯片 LED chips	PHILIPS / CREE / BRIGDELUX			
驱动 Power supply	PHILIPS driver / MW driver from taiwan / MOSO®			
透镜角度 Lens angle	120°70°			
效率 Efficiency	87%			
输入电压 Input voltage	AC85-265V			
防护等级 Protection levels	IP65			

# LED Garden Light LED 庭院灯

## 产品说明 Product description

### 材质工艺:

- 灯具设计风格简约时尚、精致典雅、浪漫古典、与城市美化完美结合。
- 灯体采用 6063 铝合金型材制造, 灯杆坚韧度高, 材料回收率高。
- 灯具光源部分采用高品质 LED 芯片及电源, 灯体侧面发光部分则配用 LED 灯带结合: 红光、蓝光、绿光、黄光、白光及 RGB 七彩变色。
- 灯体外部采用纳米多功能涂层、防粘贴、防涂鸦、防刮痕。
- 灯具应用场所: 公园、商业区、高档别墅庭院、停车场、广场、道路行人道等。

### Material and Technology:

- The product design creating is concise and fashion/delicate and elegant/classics and romantic/perfect combination and city beautification.
- The lamp body using for 6063 aluminum material,the lamp pole is high tenacity and metal material will be high reclaim.
- The light source with high quality LED chips and power supply,the lamp pole two side with LED strip for color:red/blue/green/yellow/white and RGB full color change.
- The lamp pole with Nano multi-functional coating/prevent paste/prevent scrawl/prevent scratching.
- The lamp application places:public garden/bussiness area/luxury villa garden/ park/plaza/pavements of road ,etc.

## 配光曲线 Light Distribution Curve

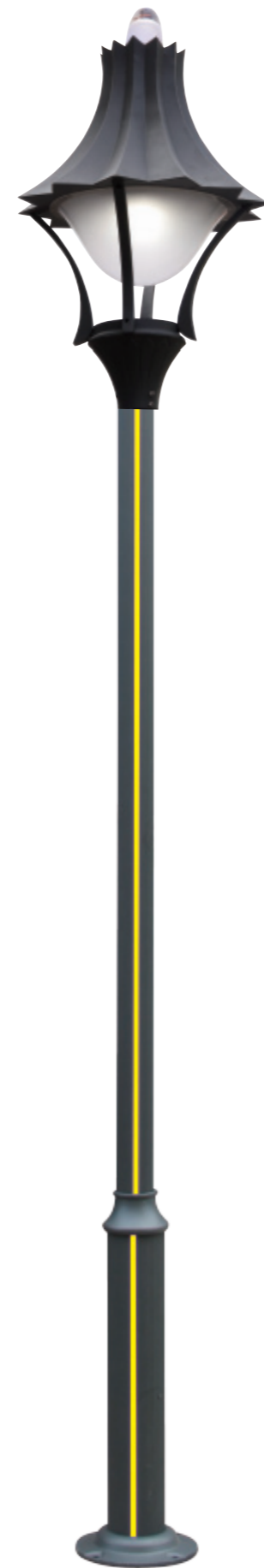
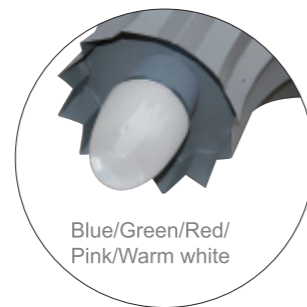
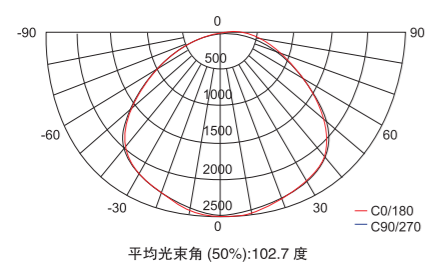

JB-GN103Z10



## 技术参数 Technology information

产品型号 Product Code	JB-GN103Z10	
灯体尺寸 Lamp size	 Φ114mm+Φ76mm	 Φ140mm+Φ89mm
产品高度 Product height	3M-3.5M	3.5M-4M
功率 Power	30W + 3W	
灯体材质 Lamp material	6063 Aluminum material	
色温 Color temp	3000K / 6000K	
灯带颜色 Strip color temp	Blue / Green / Red / Pink / Warm white	
芯片 LED chips	PHILIPS / CREE / BRIGDELUX	
驱动 Power supply	PHILIPS driver / MW driver from taiwan / MOSO®	
透镜角度 Lens angle	120°70°	
效率 Efficiency	87%	
输入电压 Input voltage	AC85-265V	
防护等级 Protection levels	IP65	





JB-GN103Z21

**产品说明 Product description**

**材质工艺:**

- 灯具设计风格简约时尚、精致典雅、浪漫古典、与城市美化完美结合。
- 灯体采用 6063 铝合金型材制造，灯杆坚韧度高，材料回收率高。
- 灯具光源部分采用高品质 LED 芯片及电源，灯体侧面发光部分则配用 LED 灯带结合：红光、蓝光、绿光、黄光、白光及 RGB 七彩变色。
- 灯体外部采用纳米多功能涂层、防粘贴、防涂鸦、防刮痕。
- 灯具应用场所：公园、商业区、高档别墅庭院、停车场、广场、道路行人道等。

**Material and Technology:**

- The product design creating is concise and fashion/delicate and elegant/classics and romantic/perfect combination and city beautification.
- The lamp body using for 6063 aluminum material, the lamp pole is high tenacity and metal material will be high reclaim.
- The light source with high quality LED chips and power supply, the lamp pole two side with LED strip for color: red/blue/green/yellow/white and RGB full color change.
- The lamp pole with Nano multi-functional coating/prevent paste/prevent scrawl/prevent scratching.
- The lamp application places: public garden/business area/luxury villa garden/ park/plaza/pavements of road ,etc.



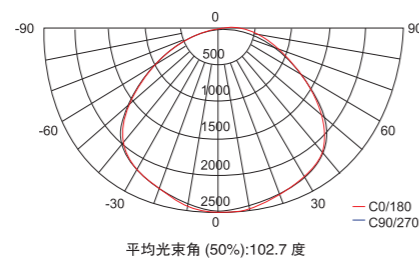

**配光曲线 Light Distribution Curve**



JB-GN103Z11



**技术参数 Technology information**

产品型号 Product Code	JB-GN103Z21		JB-GN103Z11	
灯体尺寸 Lamp size				
	Φ114mm+Φ76mm	Φ140mm+Φ89mm	Φ114mm+Φ76mm	Φ140mm+Φ89mm
产品高度 Product height	3M-3.5M	3.5M-4M	3M-3.5M	3.5M-4M
功率 Power	30W		36W	
灯体材质 Lamp material	6063 Aluminum material			
色温 Color temp	3000K / 6000K			
灯带颜色 Strip color temp	Blue / Green / Red / Pink / Warm white			
芯片 LED chips	PHILIPS / CREE / BRIGDELUX			
驱动 Power supply	PHILIPS driver / MW driver from taiwan / MOSO®			
透镜角度 Lens angle	120°70°			
效率 Efficiency	87%			
输入电压 Input voltage	AC85-265V			
防护等级 Protection levels	IP65			

## 产品说明 Product description

## 材质工艺:

- 灯具设计风格简约时尚、精致典雅、浪漫古典、与城市美化完美结合。
- 灯体采用 6063 铝合金型材制造, 灯杆坚韧度高, 材料回收率高。
- 灯具光源部分采用高品质 LED 芯片及电源, 灯体侧面发光部分则配用 LED 灯带结合: 红光、蓝光、绿光、黄光、白光及 RGB 七彩变色。
- 灯体外部采用纳米多功能涂层、防粘贴、防涂鸦、防刮痕。
- 灯具应用场所: 公园、商业区、高档别墅庭院、停车场、广场、道路行人道等。

## Material and Technology:

- The product design creating is concise and fashion/delicate and elegant/classics and romantic/perfect combination and city beautification.
- The lamp body using for 6063 aluminum material, the lamp pole is high tenacity and metal material will be high reclaim.
- The light source with high quality LED chips and power supply, the lamp pole two side with LED strip for color: red/blue/green/yellow/white and RGB full color change.
- The lamp pole with Nano multi-functional coating/prevent paste/prevent scrawl/prevent scratching.
- The lamp application places: public garden/bussiness area/luxury villa garden/ park/plaza/pavements of road .etc.

## 配光曲线 Light Distribution Curve

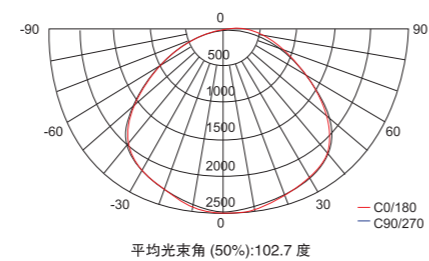

# LED Garden Light

## LED 庭院灯



JB-GN103Z23

## 技术参数 Technology information

产品型号 Product Code	JB-GN103Z23	
灯体尺寸 Lamp size	 Φ 114mm+ Φ 76mm	 Φ 140mm+ Φ 89mm
产品高度 Product height	3M-3.5M	3.5M-4M
功率 Power	60W	
灯体材质 Lamp material	6063 Aluminum material	
色温 Color temp	3000K / 6000K	
灯带颜色 Strip color temp	Blue / Green / Red / Pink / Warm white	
芯片 LED chips	PHILIPS / CREE / BRIGDELUX	
驱动 Power supply	PHILIPS driver / MW driver from taiwan / MOSO®	
透镜角度 Lens angle	120°70°	
效率 Efficiency	87%	
输入电压 Input voltage	AC85-265V	
防护等级 Protection levels	IP65	

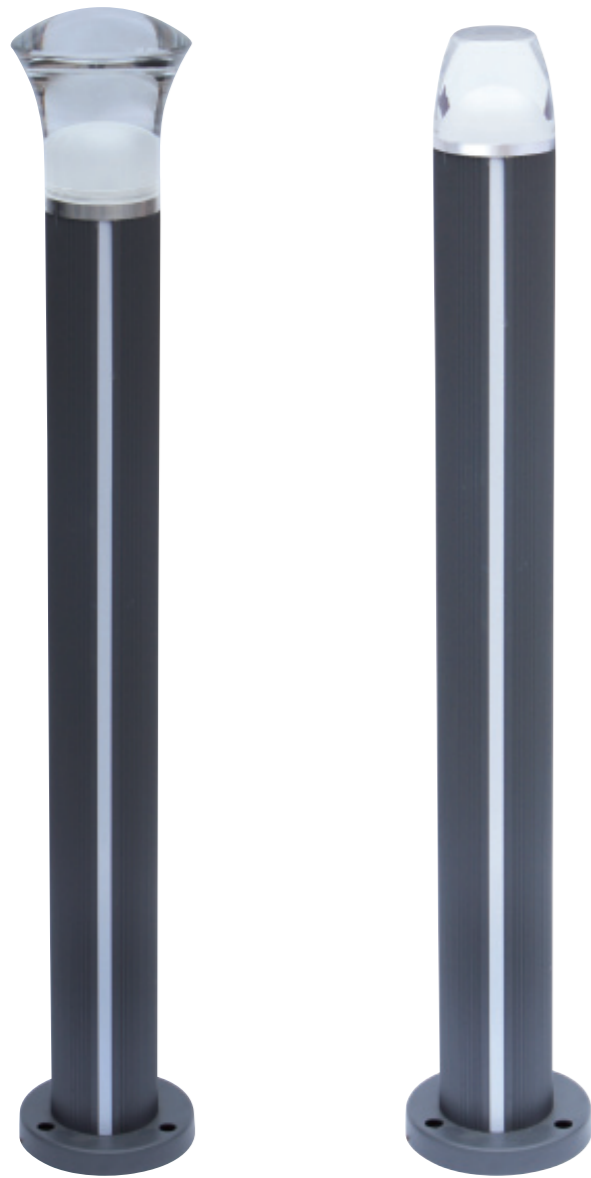

JB-GG021R6

JB-GG021R1



**产品说明 Product description**

**材质工艺:**

- 灯具设计风格简约时尚、精致典雅、浪漫古典、与城市美化完美结合。
- 灯体采用 6063 铝合金型材制造，灯杆坚韧度高，材料回收率高。
- 灯具光源部分采用高品质 LED 芯片及电源，灯体侧面发光部分则配用 LED 灯带结合：红光、蓝光、绿光、黄光、白光及 RGB 七彩变色。
- 灯体外部采用纳米多功能涂层、防粘贴、防涂鸦、防刮痕。
- 灯具应用场所：公园、商业区、高档别墅庭院、停车场、广场、道路行人道等。

**Material and Technology:**

- The product design creating is concise and fashion/delicate and elegant/classics and romantic/perfect combination and city beautification.
- The lamp body using for 6063 aluminum material,the lamp pole is high tenacity and metal material will be high reclaim.
- The light source with high quality LED chips and power supply,the lamp pole two side with LED strip for color:red/blue/green/yellow/white and RGB full color change.
- The lamp pole with Nano multi-fanctional coating/prevent paste/prevent scrawl/prevent scratching.
- The lamp application places:public garden/bussiness area/luxury villa garden/ park/plaza/pavements of road ,etc.

**技术参数 Technology information**

产品型号 Product Code	JB-GG021R1	JB-GG021R6
灯体尺寸 Lamp size	 Φ76mm	 Φ76mm
产品高度 Product height	80CM	80CM
功率 Power	5W	5W
灯体材质 Lamp material	6063 Aluminum material	
色温 Color temp	3000K / 6000K	
灯带颜色 Strip color temp	Blue / Green / Red / Pink / Warm white	
芯片 LED chips	CREE	
驱动 Power supply	JUNBO driver	
效率 Efficiency	87%	
输入电压 Input voltage	AC85-265V	
防护等级 Protection levels	IP65	



JB-GG021X2



JB-GG021X5



JB-GG021Y3

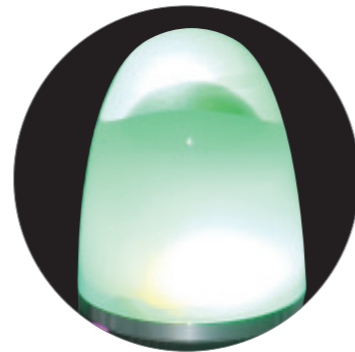

产品说明 Product description

材质工艺:

- 灯具设计风格简约时尚、精致典雅、浪漫古典、与城市美化完美结合。
- 灯体采用 6063 铝合金型材制造，灯杆坚韧度高，材料回收率高。
- 灯具光源部分采用高品质 LED 芯片及电源，灯体侧面发光部分则配用 LED 灯带结合：红光、蓝光、绿光、黄光、白光及 RGB 七彩变色。
- 灯体外部采用纳米多功能涂层、防粘贴、防涂鸦、防刮痕。
- 灯具应用场所：公园、商业区、高档别墅庭院、停车场、广场、道路行人道等。

Material and Technology:

- The product design creating is concise and fashion/delicate and elegant/classics and romantic/perfect combination and city beautification.
- The lamp body using for 6063 aluminum material,the lamp pole is high tenacity and metal material will be high reclaim.
- The light source with high quality LED chips and power supply,the lamp pole two side with LED strip for color:red/blue/green/yellow/white and RGB full color change.
- The lamp pole with Nano multi-fanctional coating/prevent paste/prevent scrawl/prevent scratching.
- The lamp application places:public garden/bussiness area/luxury villa garden/ park/plaza/pavements of road ,etc.



技术参数 Technology information

产品型号 Product Code	JB-GG025X2	JB-GG025X5	JB-GG021Y3
灯体尺寸 Lamp size	 Φ89mm	 Φ89mm	 Φ114mm
产品高度 Product height	80CM	80CM	80CM
功率 Power	7W	7W	9W
灯体材质 Lamp material	6063 Aluminum material		
色温 Color temp	3000K / 6000K		
灯带颜色 Strip color temp	Blue / Green / Red / Pink / Warm white		
芯片 LED chips	CREE		
驱动 Power supply	JUNBO driver		
效率 Efficiency	87%		
输入电压 Input voltage	AC85-265V		
防护等级 Protection levels	IP65		



**JB-GG026G4**  
专利号: 201630610590.X



**JB-GG028C2**  
专利号: 201730215689.4



**JB-GG027B2**  
专利号: 201730215690.7

**产品说明 Product description**

**材质工艺:**

- 灯具设计风格简约时尚、精致典雅、浪漫古典、与城市美化完美结合。
- 灯体采用 6063 铝合金型材制造,灯杆坚韧度高,材料回收率高。
- 灯具光源部分采用高品质 LED 芯片及电源,灯体侧面发光部分则配用 LED 灯带结合:红光、蓝光、绿光、黄光、白光及 RGB 七彩变色。
- 灯体外部采用纳米多功能涂层、防粘贴、防涂鸦、防刮痕。
- 灯具应用场所:公园、商业区、高档别墅庭院、停车场、广场、道路人行道等。

**Material and Technology:**

- The product design creating is concise and fashion/delicate and elegant/classics and romantic/perfect combination and city beautification.
- The lamp body using for 6063 aluminum material,the lamp pole is high tenacity and metal material will be high reclaim.
- The light source with high quality LED chips and power supply,the lamp pole two side with LED strip for color:red/blue/green/yellow/white and RGB full color change.
- The lamp pole with Nano multi-fanctional coating/prevent paste/prevent scrawl/prevent scratching.
- The lamp application places:public garden/bussiness area/luxury villa garden/ park/plaza/pavements of road ,etc.

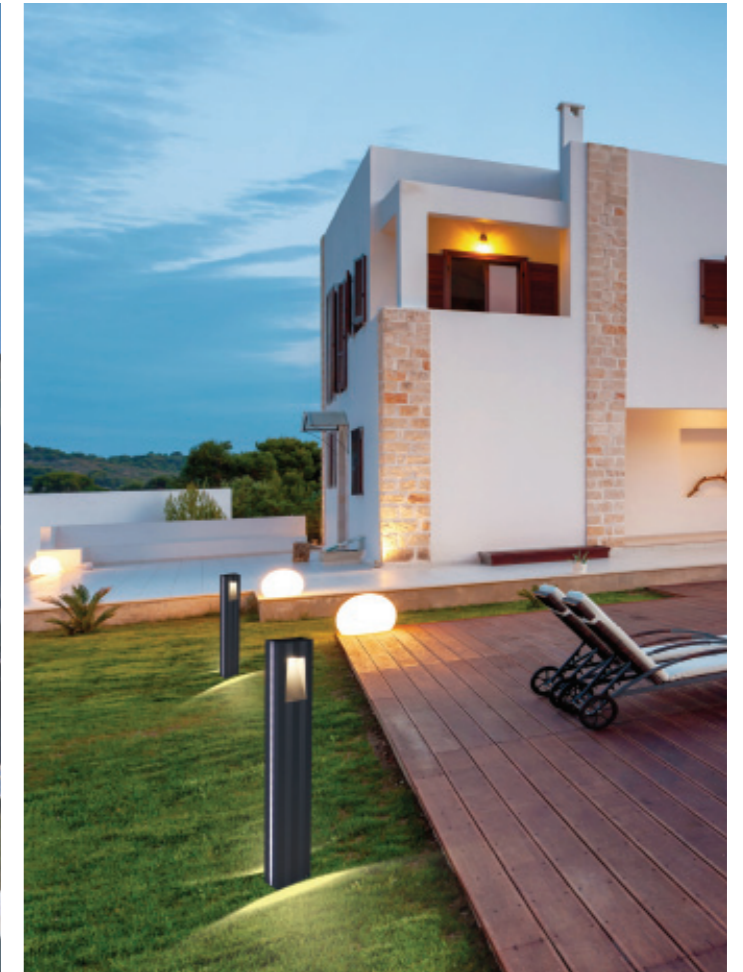

**技术参数 Technology information**

产品型号 Product Code	JB-GG026G4	JB-GG028C2	JB-GG027B2
灯体尺寸 Lamp size	 120 x 120mm	 130 x 85mm	 150 x 75mm
产品高度 Product height	80CM	80CM	80CM
功率 Power	12W	8W	8W
灯体材质 Lamp material	6063 Aluminum material		
色温 Color temp	3000K / 6000K		
灯带颜色 Strip color temp	Blue / Green / Red / Pink / Warm white		
芯片 LED chips	BRIGDELUX		
驱动 Power supply	JUNBO driver		
效率 Efficiency	87%		
输入电压 Input voltage	AC85-265V		
防护等级 Protection levels	IP65		



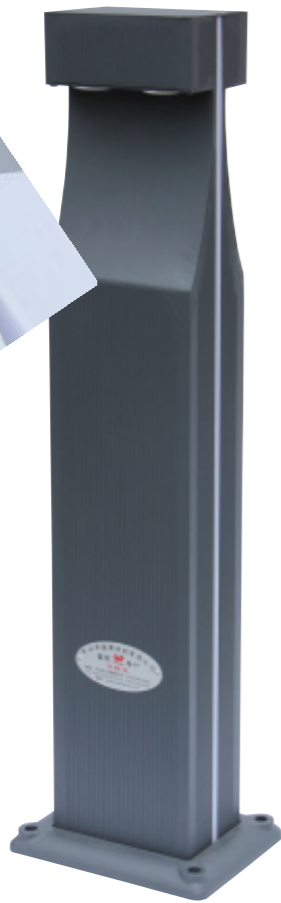
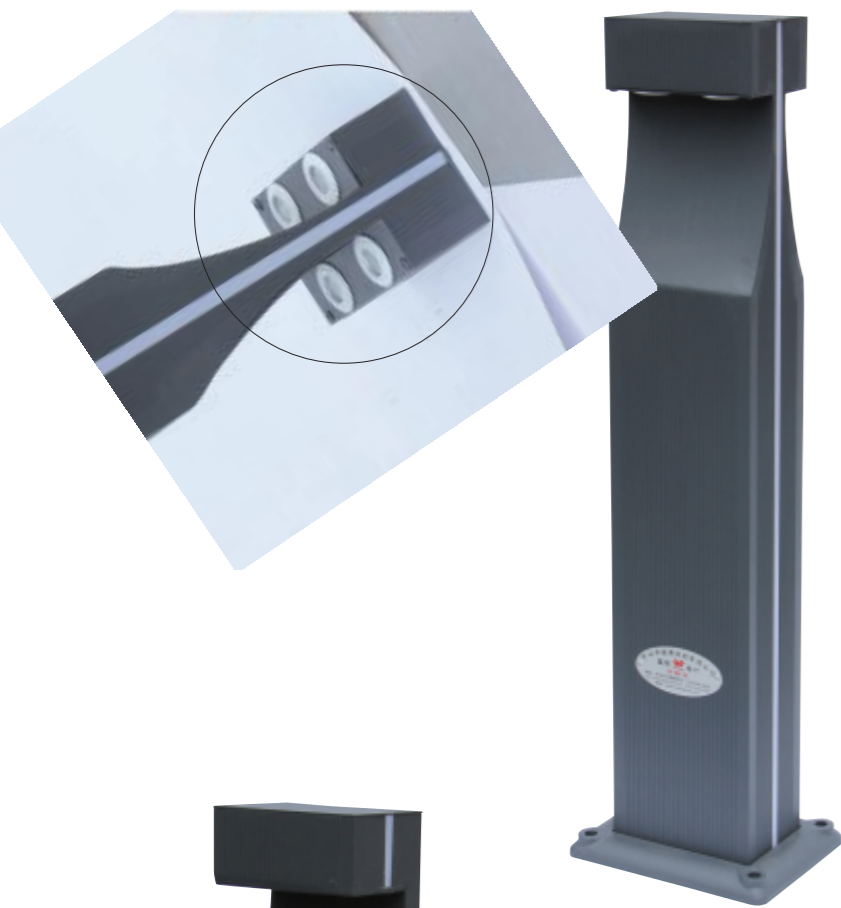

**JB-GG017A1**  
专利号: 201530149560.9

**产品说明 Product description**

- 材质工艺:
- 灯具设计风格简约时尚、精致典雅、浪漫古典、与城市美化完美结合。
  - 灯体采用 6063 铝合金型材制造, 灯杆坚韧度高, 材料回收率高。
  - 灯具光源部分采用高品质 LED 芯片及电源, 灯体侧面发光部分则配用 LED 灯带结合: 红光、蓝光、绿光、黄光、白光及 RGB 七彩变色。
  - 灯体外部采用纳米多功能涂层、防粘贴、防涂鸦、防刮痕。
  - 灯具应用场所: 公园、商业区、高档别墅庭园、停车场、广场、道路行人道等。

Material and Technology:

- The product design creating is concise and fashion/delicate and elegant/classics and romantic/perfect combination and city beautification.
- The lamp body using for 6063 aluminum material,the lamp pole is high tenacity and metal material will be high reclaim.
- The light source with high quality LED chips and power supply,the lamp pole two side with LED strip for color:red/blue/green/yellow/white and RGB full color change.
- The lamp pole with Nano multi-fanctional coating/prevent paste/prevent scrawl/prevent scratching.
- The lamp application places:public garden/bussiness area/luxury villa garden/ park/plaza/pavements of road ,etc.

**技术参数 Technology information**

产品型号 Product Code	JB-GG017A1	JB-GG019A1
灯体尺寸 Lamp size	 150*100mm	 150*100mm
产品高度 Product height	80CM	80CM
功率 Power	6W	12W
灯体材质 Lamp material	6063 Aluminum material	
色温 Color temp	3000K / 6000K	
灯带颜色 Strip color temp	Blue / Green / Red / Pink / Warm white	
芯片 LED chips	BRIGDELUX	
驱动 Power supply	JUNBO driver	
效率 Efficiency	87%	
输入电压 Input voltage	AC85-265V	
防护等级 Protection levels	IP65	

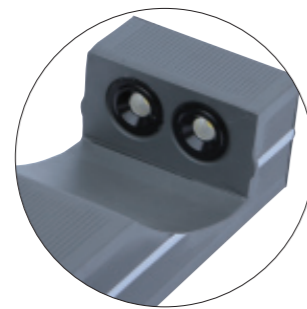

**JB-GG019A1**  
专利号: 201530149558.1





JB-GG025J1



JB-GG025J2



JB-GG025J3

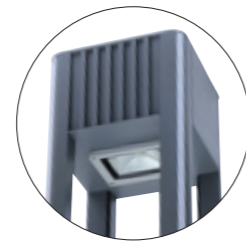

**产品说明 Product description**

**材质工艺:**

- 灯具设计风格简约时尚、精致典雅、浪漫古典、与城市美化完美结合。
- 灯体采用 6063 铝合金型材制造，灯杆坚韧度高，材料回收率高。
- 灯具光源部分采用高品质 LED 芯片及电源，灯体侧面发光部分则配备 LED 灯带结合：红光、蓝光、绿光、黄光、白光及 RGB 七彩变色。
- 灯体外部采用纳米多功能涂层、防粘贴、防涂鸦、防刮痕。
- 灯具应用场所：公园、商业区、高档别墅庭院、停车场、广场、道路行人道等。

**Material and Technology:**

- The product design creating is concise and fashion/delicate and elegant/classics and romantic/perfect combination and city beautification.
- The lamp body using for 6063 aluminum material,the lamp pole is high tenacity and metal material will be high reclaim.
- The light source with high quality LED chips and power supply,the lamp pole two side with LED strip for color:red/blue/green/yellow/white and RGB full color change.
- The lamp pole with Nano multi-fanctional coating/prevent paste/prevent scrawl/prevent scratching.
- The lamp application places:public garden/bussiness area/luxury villa garden/ park/plaza/pavements of road ,etc.

**技术参数 Technology information**

产品型号 Product Code	JB-GG025J1	JB-GG025J2	JB-GG025J3
灯体尺寸 Lamp size	 200*200mm	 200*200mm	 200*200mm
产品高度 Product height	80CM	80CM	80CM
功率 Power	10W	10W	10W
灯体材质 Lamp material	6063 Aluminum material		
色温 Color temp	3000K / 6000K		
灯带颜色 Strip color temp	Blue / Green / Red / Pink / Warm white		
芯片 LED chips	PHILIPS / BRIGDELUX		
驱动 Power supply	JUNBO driver		
效率 Efficiency	87%		
输入电压 Input voltage	AC85-265V		
防护等级 Protection levels	IP65		







**产品说明 Product description**

- 材质工艺:**
- 灯具设计风格简约时尚、精致典雅、浪漫古典、与城市美化完美结合。
  - 灯体采用 6063 铝合金型材制造，灯杆坚韧度高，材料回收率高。
  - 灯具光源部分采用高品质 LED 芯片及电源，灯体侧面发光部分则配用 LED 灯带结合：红光、蓝光、绿光、黄光、白光及 RGB 七彩变色。
  - 灯体外部采用纳米多功能涂层、防粘贴、防涂鸦、防刮痕。
  - 灯具应用场所：公园、商业区、高档别墅庭院、停车场、广场、道路行人道等。

- Material and Technology:**
- The product design creating is concise and fashion/delicate and elegant/classics and romantic/perfect combination and city beautification.
  - The lamp body using for 6063 aluminum material,the lamp pole is high tenacity and metal material will be high reclaim.
  - The light source with high quality LED chips and power supply,the lamp pole two side with LED strip for color:red/blue/green/yellow/white and RGB full color change.
  - The lamp pole with Nano multi-fanctional coating/prevent paste/prevent scrawl/prevent scratching.
  - The lamp application places:public garden/bussiness area/luxury villa garden/ park/plaza/pavements of road , etc.

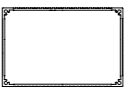
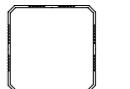
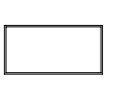

**技术参数 Technology information**

产品型号 Product Code	JB-GG029C1	JB-GG030G1	JB-GG023I2	JB-GG031D1
灯体尺寸 Lamp size	 130 x 85mm	 120 x 120mm	 200 x 80mm	 130 x 130 x 130mm
产品高度 Product height	80CM	80CM	80CM	80CM
功率 Power	5W	5W	10W	5W
灯体材质 Lamp material	6063 Aluminum material			
色温 Color temp	3000K / 6000K			
灯带颜色 Strip color temp	Blue / Green / Red / Pink / Warm white			
芯片 LED chips	CREE			
驱动 Power supply	JUNBO driver			
效率 Efficiency	87%			
输入电压 Input voltage	AC85-265V			
防护等级 Protection levels	IP65			



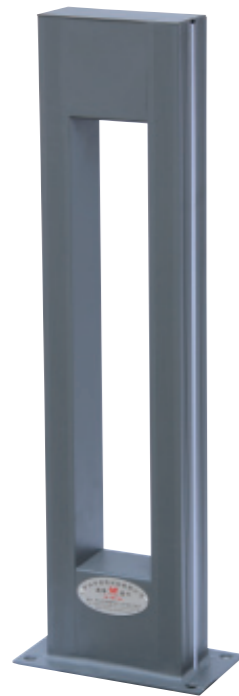

JB-GG0231



JB-GG002G1

**产品说明 Product description**

**材质工艺:**

- 灯具设计风格简约时尚、精致典雅、浪漫古典、与城市美化完美结合。
- 灯体采用 6063 铝合金型材制造，灯杆坚韧度高，材料回收率高。
- 灯具光源部分采用高品质 LED 芯片及电源，灯体侧面发光部分则配用 LED 灯带结合：红光、蓝光、绿光、黄光、白光及 RGB 七彩变色。
- 灯体外部采用纳米多功能涂层、防粘贴、防涂鸦、防刮痕。
- 灯具应用场所：公园、商业区、高档别墅庭院、停车场、广场、道路行人道等。

**Material and Technology:**

- The product design creating is concise and fashion/delicate and elegant/classics and romantic/perfect combination and city beautification.
- The lamp body using for 6063 aluminum material,the lamp pole is high tenacity and metal material will be high reclaim.
- The light source with high quality LED chips and power supply,the lamp pole two side with LED strip for color:red/blue/green/yellow/white and RGB full color change.
- The lamp pole with Nano multi-functional coating/prevent paste/prevent scrawl/prevent scratching.
- The lamp application places:public garden/bussiness area/luxury villa garden/ park/plaza/pavements of road ,etc.



JB-GG022B1

**技术参数 Technology information**

产品型号 Product Code	JB-GG00231	JB-GG002G1	JB-022B1
灯体尺寸 Lamp size	 180*80mm	 120*120mm	 150*75mm
产品高度 Product height	80CM	80CM	80CM
功率 Power	3W	9W	10W
灯体材质 Lamp material	6063 Aluminum material		
色温 Color temp	3000K / 6000K		
灯带颜色 Strip color temp	Blue / Green / Red / Pink / Warm white		
芯片 LED chips	PHILIPS / BRIGDELUX		
驱动 Power supply	JUNBO driver		
效率 Efficiency	87%		
输入电压 Input voltage	AC85-265V		
防护等级 Protection levels	IP65		





JB-W101R1



JB-W106R1

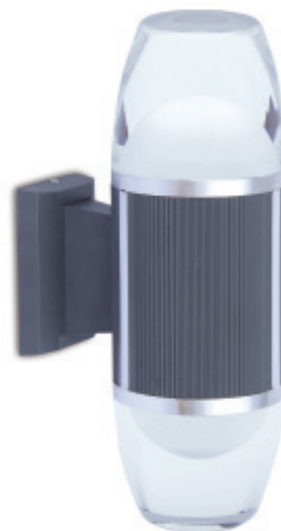

JB-W106R2

产品说明 Product description

材质工艺:

- 灯具设计风格简约时尚、精致典雅、浪漫古典、与城市美化完美结合。
- 灯体采用 6063 铝合金型材制造，灯杆坚韧度高，材料回收率高。
- 灯具光源部分采用高品质 LED 芯片及电源，灯体侧面发光部分则配有 LED 灯带结合：红光、蓝光、绿光、黄光、白光及 RGB 七彩变色。
- 灯体外部采用纳米多功能涂层、防粘贴、防涂鸦、防刮痕。
- 灯具应用场所：公园、商业区、高档别墅庭院、停车场、广场、道路行人道等。

Material and Technology:

- The product design creating is concise and fashion/delicate and elegant/classics and romantic/perfect combination and city beautification.
- The lamp body using for 6063 aluminum material,the lamp pole is high tenacity and metal material will be high reclaim.
- The light source with high quality LED chips and power supply,the lamp pole two side with LED strip for color:red/blue/green/yellow/white and RGB full color change.
- The lamp pole with Nano multi-fanctional coating/prevent paste/prevent scrawl/prevent scratching.
- The lamp application places:public garden/bussiness area/luxury villa garden/ park/plaza/pavements of road ,etc.

技术参数 Technology information

产品型号 Product Code	JB-W101R1	JB-W106R1	JB-W106R2
灯体尺寸 Lamp size	 Φ76mm	 Φ76mm	 Φ76mm
功率 Power	5W	5W	2*5W
灯体材质 Lamp material	6063 Aluminum material		
色温 Color temp	3000K / 6000K		
灯带颜色 Strip color temp	Blue / Green / Red / Pink / Warm white		
芯片 LED chips	CREE		
驱动 Power supply	JUNBO driver		
效率 Efficiency	87%		
输入电压 Input vottage	AC85-265V		
防护等级 Protection levels	IP65		



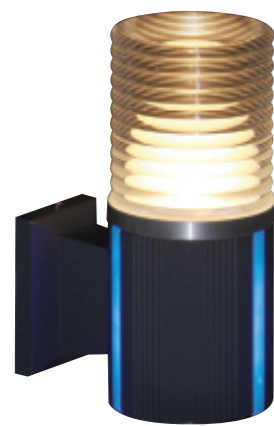

JB-W102X1



JB-W102X1D  
专利号: 201630614607.9



JB-W105X1



产品说明 Product description

- 材质工艺:
- 灯具设计风格简约时尚、精致典雅、浪漫古典、与城市美化完美结合。
  - 灯体采用 6063 铝合金型材制造,灯杆坚韧度高,材料回收率高。
  - 灯具光源部分采用高品质 LED 芯片及电源,灯体侧面发光部分则配用 LED 灯带结合:红光、蓝光、绿光、黄光、白光及 RGB 七彩变色。
  - 灯体外部采用纳米多功能涂层、防粘贴、防涂鸦、防刮痕。
  - 灯具应用场所:公园、商业区、高档别墅庭院、停车场、广场、道路行人道等。

Material and Technology:

- The product design creating is concise and fashion/delicate and elegant/classics and romantic/perfect combination and city beautification.
- The lamp body using for 6063 aluminum material,the lamp pole is high tenacity and metal material will be high reclaim.
- The light source with high quality LED chips and power supply,the lamp pole two side with LED strip for color:red/blue/green/yellow/white and RGB full color change.
- The lamp pole with Nano multi-fancional coating/prevent paste/prevent scrawl/prevent scratching.
- The lamp application places:public garden/bussiness area/luxury villa garden/ park/plaza/pavements of road ,etc.

技术参数 Technology information

产品型号 Product Code	JB-W102X1	JB-W102X1D	JB-W105X1
灯体尺寸 Lamp size	 Φ 89mm	 Φ 89mm	 Φ 89mm
功率 Power	7W	2*7W	7W
灯体材质 Lamp material	6063 Aluminum material		
色温 Color temp	3000K / 6000K		
灯带颜色 Strip color temp	Blue / Green / Red / Pink / Warm white		
芯片 LED chips	CREE		
驱动 Power supply	JUNBO driver		
效率 Efficiency	87%		
输入电压 Input voltage	AC85-265V		
防护等级 Protection levels	IP65		

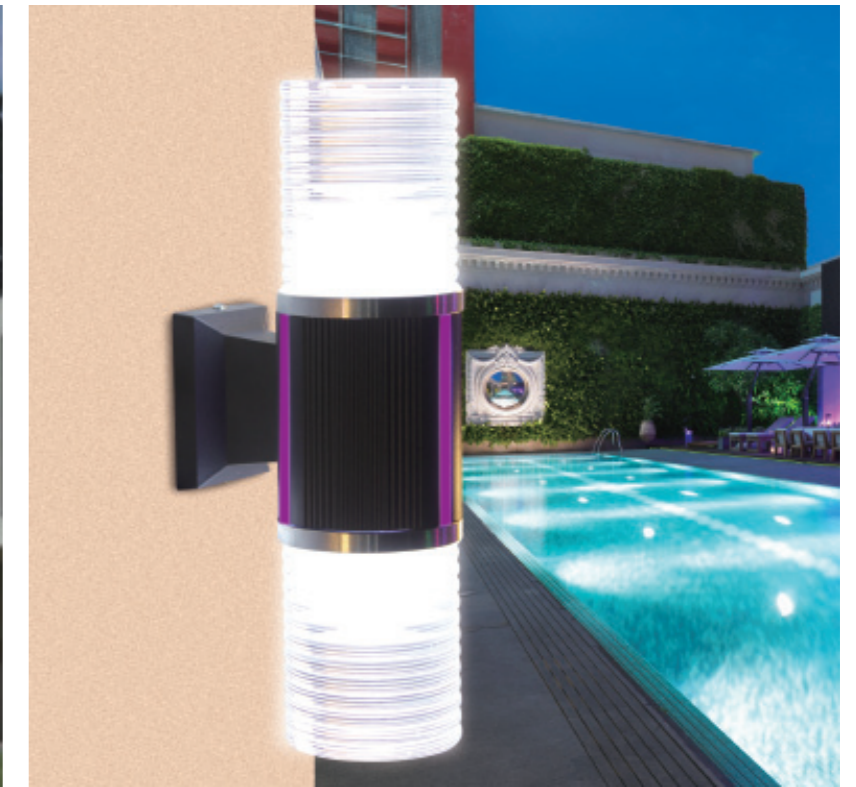



**JB-W103Y1**  
专利号: 201630614609.8

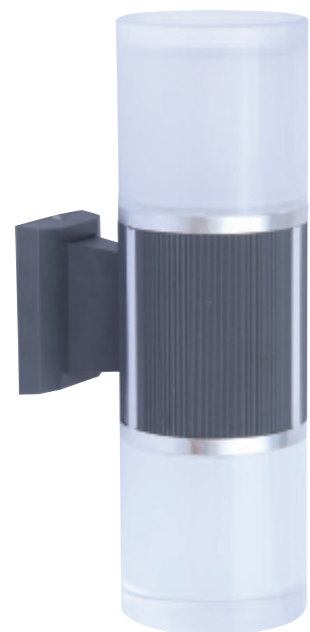

**JB-W103Y1D**

**产品说明 Product description**

- 材质工艺:
- 灯具设计风格简约时尚、精致典雅、浪漫古典、与城市美化完美结合。
  - 灯体采用 6063 铝合金型材制造,灯杆坚韧度高,材料回收率高。
  - 灯具光源部分采用高品质 LED 芯片及电源,灯体侧面发光部分则配用 LED 灯带结合:红光、蓝光、绿光、黄光、白光及 RGB 七彩变色。
  - 灯体外部采用纳米多功能涂层、防粘贴、防涂鸦、防刮痕。
  - 灯具应用场所:公园、商业区、高档别墅庭院、停车场、广场、道路行人道等。

- Material and Technology:
- The product design creating is concise and fashion/delicate and elegant/classics and romantic/perfect combination and city beautification.
  - The lamp body using for 6063 aluminum material,the lamp pole is high tenacity and metal material will be high reclaim.
  - The light source with high quality LED chips and power supply,the lamp pole two side with LED strip for color:red/blue/green/yellow/white and RGB full color change.
  - The lamp pole with Nano multi-fanctional coating/prevent paste/prevent scrawl/prevent scratching.
  - The lamp application places:public garden/bussiness area/luxury villa garden/ park/plaza/pavements of road ,etc.

**技术参数 Technology information**

产品型号 Product Code	JB-W103Y1	JB-W103Y1D
灯体尺寸 Lamp size	 Φ 114mm	 Φ 114mm
功率 Power	9W	2*9W
灯体材质 Lamp material	6063 Aluminum material	
色温 Color temp	3000K / 6000K	
灯带颜色 Strip color temp	Blue / Green / Red / Pink / Warm white	
芯片 LED chips	CREE	
驱动 Power supply	JUNBO driver	
效率 Efficiency	87%	
输入电压 Input voltage	AC85-265V	
防护等级 Protection levels	IP65	



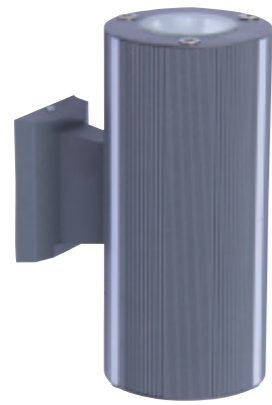

**JB-W205Y3D**  
专利号: 201630614577.4



**JB-W202D3D**  
专利号: 201630614558.9



**JB-W205Y3**



**JB-W202D3**

### 产品说明 Product description





#### 材质工艺:

- 灯具设计风格简约时尚、精致典雅、浪漫古典、与城市美化完美结合。
- 灯体采用 6063 铝合金型材制造,灯杆坚韧度高,材料回收率高。
- 灯具光源部分采用高品质 LED 芯片及电源,灯体侧面发光部分则配用 LED 灯带结合:红光、蓝光、绿光、黄光、白光及 RGB 七彩变色。
- 灯体外部采用纳米多功能涂层、防粘贴、防涂鸦、防刮痕。
- 灯具应用场所:公园、商业区、高档别墅庭院、停车场、广场、道路行人道等。

#### Material and Technology:

- The product design creating is concise and fashion/delicate and elegant/classics and romantic/perfect combination and city beautification.
- The lamp body using for 6063 aluminum material,the lamp pole is high tenacity and metal material will be high reclaim.
- The light source with high quality LED chips and power supply,the lamp pole two side with LED strip for color:red/blue/green/yellow/white and RGB full color change.
- The lamp pole with Nano multi-functional coating/prevent paste/prevent scrawl/prevent scratching.
- The lamp application places:public garden/bussiness area/luxury villa garden/ park/plaza/pavements of road ,etc.

### 技术参数 Technology information

产品型号 Product Code	JB-W205Y3	JB-W205Y3D	JB-W202D3	JB-W202D3D
灯体尺寸 Lamp size	 Φ114mm	 Φ114mm	 130*130*130mm	 130*130*130mm
功率 Power	COB 7W	2*COB 7W	COB 10W	2*COB 10W
灯体材质 Lamp material	6063 Aluminum material			
色温 Color temp	3000K / 6000K			
灯带颜色 Strip color temp	Blue / Green / Red / Pink / Warm white			
芯片 LED chips	BRIGDELUX			
驱动 Power supply	PHILIPS driver / MW driver from taiwan			
效率 Efficiency	87%			
输入电压 Input voltage	AC85-265V			
防护等级 Protection levels	IP65			



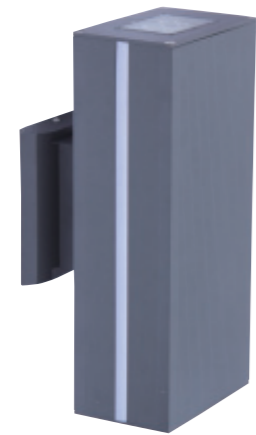

**JB-W207C2D**

专利号: 201630614560.6



**JB-W206A3D**

专利号: 201630614606.4



**JB-W207C2**

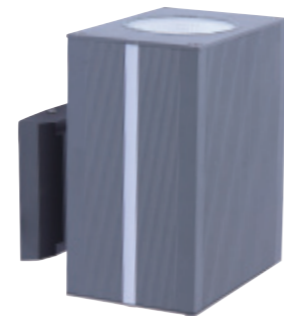

**JB-W206A3**

**产品说明 Product description**

**材质工艺:**

- 灯具设计风格简约时尚、精致典雅、浪漫古典、与城市美化完美结合。
- 灯体采用 6063 铝合金型材制造，灯杆坚韧度高，材料回收率高。
- 灯具光源部分采用高品质 LED 芯片及电源，灯体侧面发光部分则配有 LED 灯带结合：红光、蓝光、绿光、黄光、白光及 RGB 七彩变色。
- 灯体外部采用纳米多功能涂层、防粘贴、防涂鸦、防刮痕。
- 灯具应用场所：公园、商业区、高档别墅庭院、停车场、广场、道路行人道等。

**Material and Technology:**

- The product design creating is concise and fashion/delicate and elegant/classics and romantic/perfect combination and city beautification.
- The lamp body using for 6063 aluminum material, the lamp pole is high tenacity and metal material will be high reclaim.
- The light source with high quality LED chips and power supply, the lamp pole two side with LED strip for color:red/blue/green/yellow/white and RGB full color change.
- The lamp pole with Nano multi-functional coating/prevent paste/prevent scrawl/prevent scratching.
- The lamp application places:public garden/bussiness area/luxury villa garden/ park/plaza/pavements of road ,etc.

**技术参数 Technology information**

产品型号 Product Code	JB-W207C2	JB-W207C2D	JB-W206A3	JB-W206A3D
灯体尺寸 Lamp size	 130*85mm	 130*85mm	 150*100mm	 150*100mm
功率 Power	6W	2*6W	COB 10W	2*COB 10W
灯体材质 Lamp material	6063 Aluminum material			
色温 Color temp	3000K / 6000K			
灯带颜色 Strip color temp	Blue / Green / Red / Pink / Warm white			
芯片 LED chips	BRIGDELUX			
驱动 Power supply	PHILIPS driver / MW driver from taiwan			
效率 Efficiency	87%			
输入电压 Input voltage	AC85-265V			
防护等级 Protection levels	IP65			

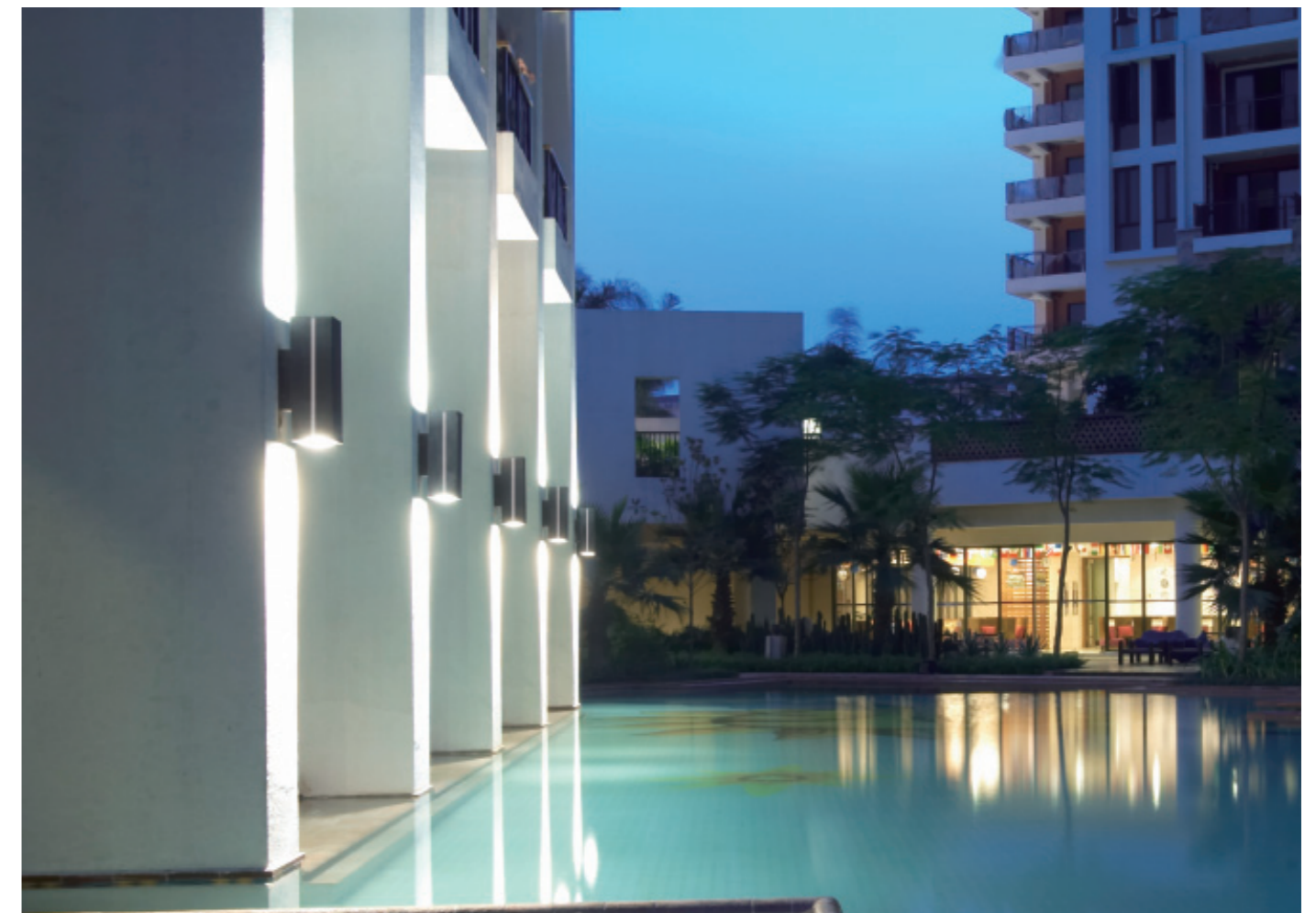
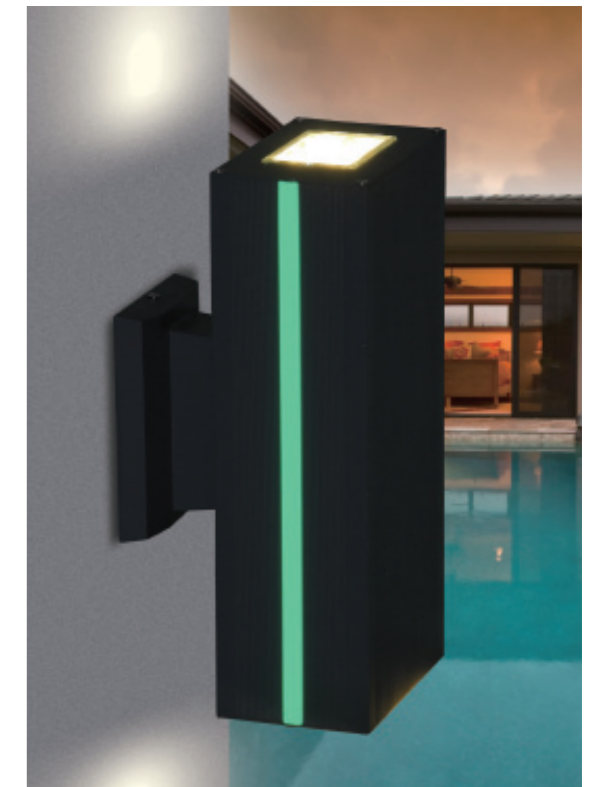

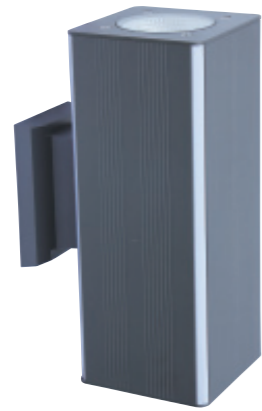

JB-W208G3D

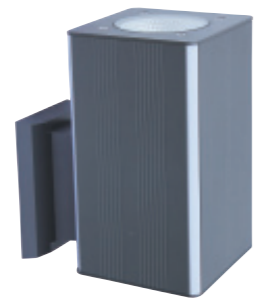

JB-W208G3

专利号: 201630614559.3



JB-W209E5D

专利号: 201630614608.3



## 产品说明 Product description

## 材质工艺:

- 灯具设计风格简约时尚、精致典雅、浪漫古典、与城市美化完美结合。
- 灯体采用 6063 铝合金型材制造, 灯杆坚韧度高, 材料回收率高。
- 灯具光源部分采用高品质 LED 芯片及电源, 灯体侧面发光部分则选用 LED 灯带结合: 红光、蓝光、绿光、黄光、白光及 RGB 七彩变色。
- 灯体外部采用纳米多功能涂层、防粘贴、防涂鸦、防刮痕。
- 灯具应用场所: 公园、商业区、高档别墅庭院、停车场、广场、道路行人道等。

## Material and Technology:

- The product design creating is concise and fashion/delicate and elegant/classics and romantic/perfect combination and city beautification.
- The lamp body using for 6063 aluminum material, the lamp pole is high tenacity and metal material will be high reclaim.
- The light source with high quality LED chips and power supply, the lamp pole two side with LED strip for color: red/blue/green/yellow/white and RGB full color change.
- The lamp pole with Nano multi-fancional coating/prevent paste/prevent scrawl/prevent scratching.
- The lamp application places: public garden/bussiness area/luxury villa garden/ park/plaza/pavements of road, etc.

## 技术参数 Technology information

产品型号 Product Code	JB-W208G3	JB-W208G3D	JB-W209E5D
灯体尺寸 Lamp size	 120*120mm	 120*120mm	 150*60mm
功率 Power	COB 10W	2*COB 10W	2*COB 3W
灯体材质 Lamp material	6063 Aluminum material		
色温 Color temp	3000K / 6000K		
灯带颜色 Strip color temp	Blue / Green / Red / Pink / Warm white		
芯片 LED chips	CREE		
驱动 Power supply	JUNBO driver		
效率 Efficiency	87%		
输入电压 Input voltage	AC85-265V		
防护等级 Protection levels	IP65		



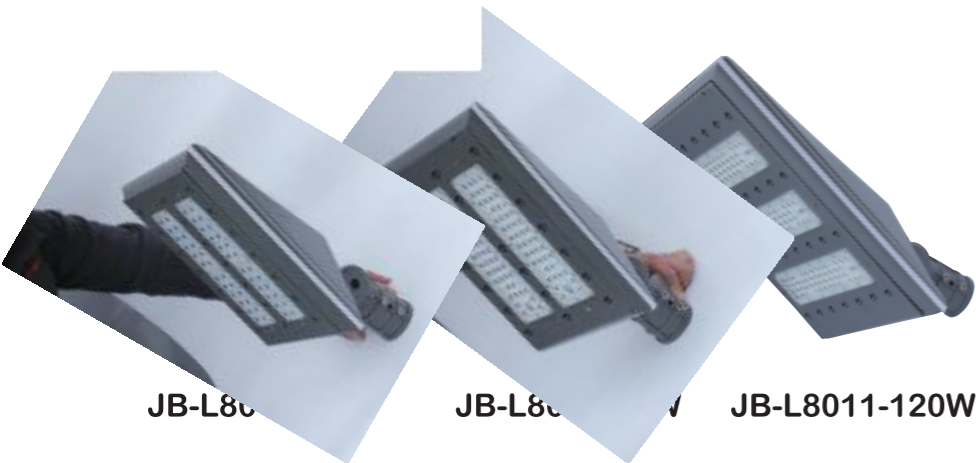

JB-L8011-120W

JB-L8011-120W

JB-L8011-120W

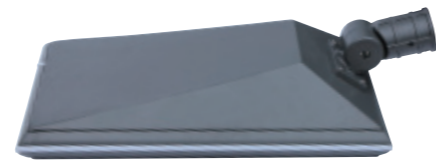

产品说明 Product description

材质工艺:

- 灯具设计风格简约时尚、精致典雅、浪漫古典、与城市美化完美结合。
- 灯体采用 6063 铝合金型材制造，灯杆坚韧度高，材料回收率高。
- 灯具光源部分采用高品质 LED 芯片及电源，灯体侧面发光部分则配用 LED 灯带结合：红光、蓝光、绿光、黄光、白光及 RGB 七彩变色。
- 灯体外部采用纳米多功能涂层、防粘贴、防涂鸦、防刮痕。
- 灯具应用场所：公园、商业区、高档别墅庭院、停车场、广场、道路行人道等。

Material and Technology:

- The product design creating is concise and fashion/delicate and elegant/classics and romantic/perfect combination and city beautification.
- The lamp body using for 6063 aluminum material,the lamp pole is high tenacity and metal material will be high reclaim.
- The light source with high quality LED chips and power supply,the lamp pole two side with LED strip for color:red/blue/green/yellow/white and RGB full color change.
- The lamp pole with Nano multi-fanctional coating/prevent paste/prevent scrawl/prevent scratching.
- The lamp application places:public garden/bussiness area/luxury villa garden/ park/plaza/pavements of road ,etc.

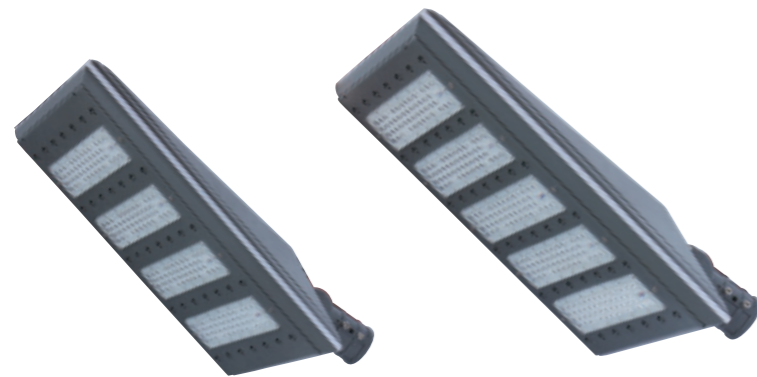

JB-L8011-160W

JB-L8011-200W

专利号：201730133229.7

技术参数 Technology information

产品型号 Product Code	JB-L8011-40W	JB-L8011-60W	JB-L8011-80W	JB-L8011-120W	JB-L8011-160W	JB-L8011-200W
灯体尺寸 Lamp size	530*360*165mm	530*360*165mm	620*360*165mm	620*360*165mm	720*360*165mm	720*360*165mm
功率 Power	40W	60W	80W	120W	160W	200W
灯体材质 Lamp material	6063 Aluminum material					
色温 Color temp	3000K / 6000K					
灯带颜色 Strip color temp	Blue / Green / Red / Pink / Warm white					
芯片 LED chips	PHILIPS / CREE					
驱动 Power supply	PHILIPS driver / MW driver from taiwan					
透镜角度 Lens Angle	120° - 150°					
效率 Efficiency	87%					
输入电压 Input voltage	AC85-265V					
防护等级 Protection levels	IP65					







JB-3608P

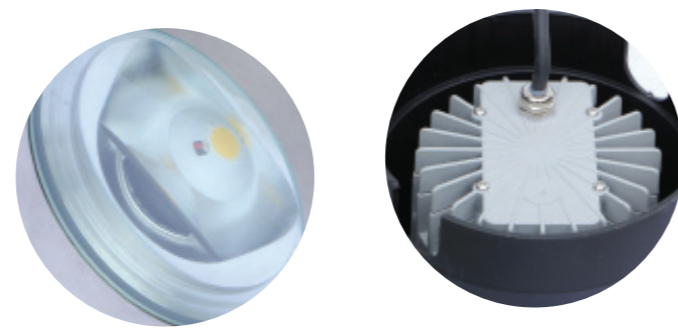

技术参数 Technology information

产品型号	Product Code	JB-3608P
灯体尺寸	Lamp size	Φ180mm
功率	Power	15W
灯体材质	Lamp material	304 Stainless steel + Aluminum + PC
色温	Color temp	3000K / 6000K
芯片	LED chips	CREE
驱动	Power Supply	MW Driver From Taiwan
效率	Efficiency	87%
输入电压	Input voltage	AC85-265V
防护等级	Protection levels	IP65



JB-3615A3

JB-3615A5

JB-3615A5

JB-3615A9

技术参数 Technology information

产品型号	Product Code	JB-3615A3	JB-3615A5	JB-3615A9	JB-3615A3	JB-3615A5	JB-3615A9
灯体尺寸	Lamp size	Φ100mm	Φ155mm	Φ200mm	Φ100mm	Φ155mm	Φ200mm
功率	Power	3*1W	5*1W/6*1W/7*1W	9*1W/12*1W	COB 3W-5W	COB 7W-15W	COB 20W-30W
灯体材质	Lamp material	304 Stainless steel + Aluminum + PC			304 Stainless steel + Aluminum + PC		
色温	Color temp	3000K / 6000K / Blue / Red / Green			3000K / 6000K		
芯片	LED chips	BRIGDELUX			BRIGDELUX		
驱动	Power Supply	JUNBO driver			JUNBO driver		
效率	Efficiency	87%			87%		
输入电压	Input voltage	AC85-265V			AC85-265V		
防护等级	Protection levels	IP65			IP65		

产品说明 Product description

材质工艺:

- 灯具设计风格简约时尚、精致典雅、浪漫古典、与城市美化完美结合。
- 灯体采用 6063 铝合金型材制造，灯杆坚韧度高，材料回收率高。
- 灯具光源部分采用高品质 LED 芯片及电源，灯体侧面发光部分则配用 LED 灯带结合：红光、蓝光、绿光、黄光、白光及 RGB 七彩变色。
- 灯体外部采用纳米多功能涂层、防粘贴、防涂鸦、防刮痕。
- 灯具应用场所：公园、商业区、高档别墅庭院、停车场、广场、道路行人道等。

Material and Technology:

- The product design creating is concise and fashion/delicate and elegant/classics and romantic/perfect combination and city beautification.
- The lamp body using for 6063 aluminum material,the lamp pole is high tenacity and metal material will be high reclaim.
- The light source with high quality LED chips and power supply,the lamp pole two side with LED strip for color:red/blue/green/yellow/white and RGB full color change.
- The lamp pole with Nano multi-fanctional coating/prevent paste/prevent scrawl/prevent scratching.
- The lamp application places:public garden/bussiness area/luxury villa garden/ park/plaza/pavements of road ,etc.

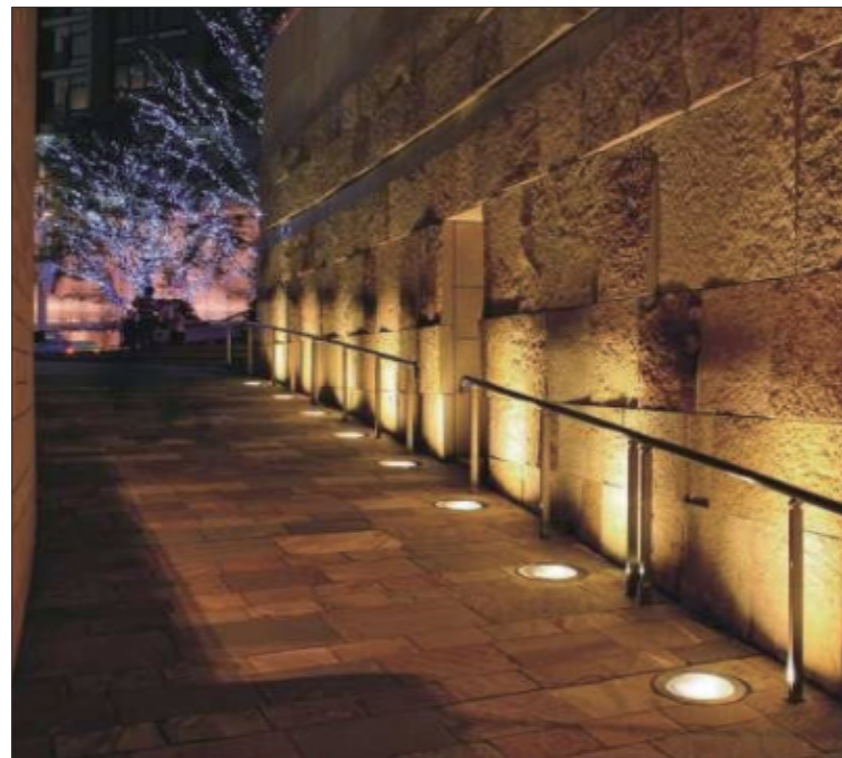

产品说明 Product description

材质工艺:

- 灯具设计风格简约时尚、精致典雅、浪漫古典、与城市美化完美结合。
- 灯体采用 6063 铝合金型材制造，灯杆坚韧度高，材料回收率高。
- 灯具光源部分采用高品质 LED 芯片及电源，灯体侧面发光部分则配用 LED 灯带结合：红光、蓝光、绿光、黄光、白光及 RGB 七彩变色。
- 灯体外部采用纳米多功能涂层、防粘贴、防涂鸦、防刮痕。
- 灯具应用场所：公园、商业区、高档别墅庭院、停车场、广场、道路行人道等。

Material and Technology:

- The product design creating is concise and fashion/delicate and elegant/classics and romantic/perfect combination and city beautification.
- The lamp body using for 6063 aluminum material,the lamp pole is high tenacity and metal material will be high reclaim.
- The light source with high quality LED chips and power supply,the lamp pole two side with LED strip for color:red/blue/green/yellow/white and RGB full color change.
- The lamp pole with Nano multi-fanctional coating/prevent paste/prevent scrawl/prevent scratching.
- The lamp application places:public garden/bussiness area/luxury villa garden/ park/plaza/pavements of road ,etc.



## 技术参数 Technology information

产品型号	Product Code	JB-5615A3	JB-5615A5	JB-5615A9	JB-5616C3	JB-5616C5	JB-5616C9
灯体尺寸	Lamp size	Φ100mm	Φ155mm	Φ200mm	Φ100mm	Φ155mm	Φ200mm
功率	Power	3*1W	5*1W/6*1W/7*1W	9*1W/12*1W	COB 3W-5W	COB 7W-15W	COB 20W-30W
灯体材质	Lamp material	Aluminum			304 Stainless steel + Aluminum + PC		
色温	Color temp	3000K / 6000K / Blue / Red / Green			3000K / 6000K		
芯片	LED chips	BRIGDELUX			BRIGDELUX		
驱动	Power Supply	JUNBO driver			JUNBO driver		
效率	Efficiency	87%			87%		
输入电压	Input voltage	AC85-265V			AC85-265V		
防护等级	Protection levels	IP65			IP65		



JB-5615A5

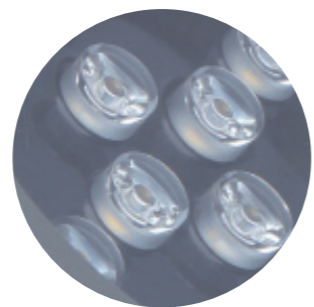

JB-5615A9

## 产品说明 Product description

## 材质工艺:

- 灯具设计风格简约时尚、精致典雅、浪漫古典、与城市美化完美结合。
- 灯体采用 6063 铝合金型材制造，灯杆坚韧度高，材料回收率高。
- 灯具光源部分采用高品质 LED 芯片及电源，灯体侧面发光部分则配用 LED 灯带结合：红光、蓝光、绿光、黄光、白光及 RGB 七彩变色。
- 灯体外部采用纳米多功能涂层、防粘贴、防涂鸦、防刮痕。
- 灯具应用场所：公园、商业区、高档别墅庭园、停车场、广场、道路行人道等。

## Material and Technology:

- The product design creating is concise and fashion/delicate and elegant/classics and romantic/perfect combination and city beautification.
- The lamp body using for 6063 aluminum material, the lamp pole is high tenacity and metal material will be high reclaim.
- The light source with high quality LED chips and power supply, the lamp pole two side with LED strip for color:red/blue/green/yellow/white and RGB full color change.
- The lamp pole with Nano multi-functional coating/prevent paste/prevent scrawl/prevent scratching.
- The lamp application places: public garden/bussiness area/luxury villa garden/ park/plaza/pavements of road ,etc.

